

# Experimental and Numerical Investigation of Air Ejector with Diffuser with Boundary Layer Suction

Vaclav Dvorak

**Abstract**—The article deals with experimental and numerical investigation of axi-symmetric subsonic air to air ejector with diffuser adapted for boundary layer suction. The diffuser, which is placed behind the mixing chamber of the ejector, has high divergence angle and therefore low efficiency. To increase the efficiency, the diffuser is equipped with slot enabling boundary layer suction. The effect of boundary layer suction on flow in ejector, static pressure distribution on the mixing chamber wall and characteristic were measured and studied numerically. Both diffuser and ejector efficiency were evaluated. The diffuser efficiency was increased, however, the efficiency of ejector itself remained low.

**Keywords**—Air ejector, boundary layer suction, CFD, diffuser.

## I. INTRODUCTION

THE article deals with experimental and numerical investigation into the flow in an air ejector with diffuser with boundary layer suction. Ejectors are used for many purposes, but the process is basically the same in every case: a high-pressure fluid (the primary stream) transfers part of its energy to a low pressure fluid (the secondary stream) and the resulting mixture is discharged at a pressure that lies between the driving pressure and the suction pressure. By the time that Keenan, Neumann and Lustwerk [1] performed the first comprehensive study of mixing, two cases of mixing were distinguished: the constant pressure mixing and the constant area mixing. However, nobody has yet established a definite link between the performance of constant area and constant pressure ejectors, as stated Sun and Eames [2]. Many studies deal with optimization of some separated parameters of ejector or with intensification of the mixing process, as they are in a review carried out by Porter and Squyers [3] and published in 1976.

The diffusers often play an essential role in many applications; therefore many researchers were concerned in diffuser design, as it was summarized by Japikse and Baines in work [4]. The efficiency of diffusers with high enlargement can be improved by boundary layer suction. For example, Furuya, Sato and Kushida [5] published a detailed, quantitative investigation of the simple conical diffuser with

inlet suction similar to the one shown in Fig. 1. They found that the diffuser effectiveness could be improved substantially, especially at large divergence angles, with the use of fairly modest suction levels of 2-5%. These authors found, by experimentation and detailed measurement, that the optimum rate of suction corresponded roughly to the condition where the initial boundary layer thickness was decreased to zero by the suction through a single slit. Their results for diffuser with divergence angle of 40°, inlet diameter of 80 (mm) and enlargement ratio of 3.52 are in Fig. 10.

Boundary layer suction is also applied while using Griffith diffuser, where the suction causes a sudden deceleration in the fluid near the wall to a low velocity level which is maintained constant through the diverging section. Authors Yang, Hudson and Nelson [6] measured diffuser effectiveness, after correcting for the suction flow, in the range of 90-95% for conical and annular diffusers.

Another approach was used by Rockwell [7], who applied perforated walls for boundary layer suction, but these results were not so excellent. By contrast to the techniques described above, the suction rates were quite high and the flow stability was limited.

If the diffuser is a part of an ejector, the boundary layer suction can be performed by ejector itself. For example, Earl in work [8] used described arrangement while a supersonic ejector was investigated, but boundary layer suction did not bring any improvement. Firstly, the diffuser with low divergence angle of 6° was used. Secondly, the sucked fluid was returned into the suction chamber in front of the ejector. Thus, the energy, which was obtained by the fluid in the mixing chamber before the suction, was dissipated.

Nowadays commercial CFD software is used by a large number of researchers. One of the first works using commercial CFD software to compute the flow in an ejector was work of Riffat, Gan and Smith [9], who took into account incompressible fluid and turbulence model  $k-\epsilon$ . Also software Fluent is widely used to compute flow both in supersonic and subsonic ejectors. E.g. Rusly, Lu Aye and Charters [10] used Fluent and segregated solver to compute flow in a supersonic ejector. Model realizable  $k-\epsilon$  seemed to be the most suitable for axi-symmetric mixing problems according the results in work of Dvorak [11]. Others researchers uses different turbulence models, e. g. Bartosiewicz, Aidoun, Desevaux and Mercadier used turbulence model SST  $k-\omega$  to simulate the flow in supersonic ejectors in work [12]. Simak [13] studied numerically flow in two-dimensional supersonic ejector by

Manuscript received September 20, 2012. This project was realized with financial support by the Czech Science Foundation, grant no. P101/10/1709.

Vaclav Dvorak is with the Department of Power Engineering Equipment, Faculty of Mechanical Engineering, Technical University of Liberec, Studentska 2, 46007 Liberec, Czech Republic (phone: +420 485 353 479; fax: +420 485 353 644; e-mail: vaclav.dvorak@tul.cz).



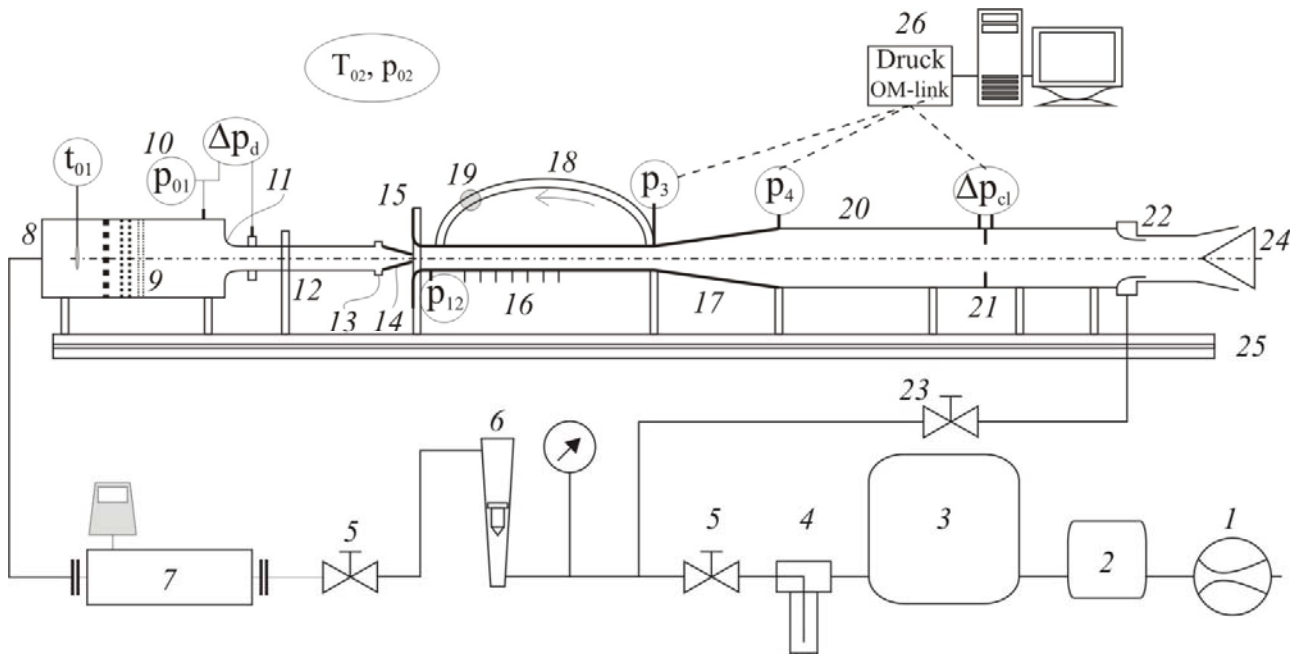

Fig. 2 Experimental arrangement: 1 - compressor, 2 - air dryer, 3 - tank, 4 - filter, 5 - reduction valve, 6 - rotameter, 7 - Coriolis mass flow meter, 8 - stilling chamber, 9 - stilling riddles, 10 - measuring of primary stagnation pressure  $p_{01}$ , 11 - measuring of primary mass flow rate, 12 - primary flow supply tube, 13 - holder of primary nozzle, 14 - primary nozzle, 15 - secondary nozzle, 16 - mixing chamber with static pressure taps, 17 - diffuser with suction slot, 18 - suction tube, 19 - velocity probe, 20 - outflow pipe, 21 - measuring of total mass flow rate, 22 - suction ejector, 23 - control valve, 24 - choking, 25 - base, 26 - pneumatic measuring.

The experimental arrangement is shown and described in Fig. 2. We used primary nozzle with diameter of 19.2 (mm) and mixing chamber of diameter  $D = 40$  (mm), i.e. the inlet area ratio of nozzles is  $\mu = A_1/A_2 = 0.3$ . The length of the mixing chamber was  $9D = 360$  (mm), the diffuser has divergence angle of  $40^\circ$  and enlargement ratio  $\mu_D = A_4/A_3 = 3.15$ .

Three mass flow rates were measured: Primary mass flow rate  $m_1$  was measured with a nozzle, mass flow rate behind the ejector  $m_4$  was measured by an orifice and suction mass flow rate  $m_3 - m_4$  was measured by velocity probe, which was situated in the suction tube and calibrated by a rotameter, see Fig. 2. The primary air was supplied by a compressor and it had overpressure  $p_{01} - p_{02} = 1$  (kPa), while secondary air was sucked directly from the laboratory and secondary stagnation pressure was equal to atmospheric pressure. For pressure measuring, we used pressure sensors Druck LP 1000 with range 100, 500, 1000 and 2000 (Pa). These low pressure sensors with high accuracy 0.25% are slow, so only mean value of pressures were measured.

### B. Numerical Investigation

For numerical calculation we used commercial software Ansys - Fluent 14. Turbulence model realizable  $k-\epsilon$  with enhanced wall treatment was used for numerical computations. This turbulence model is suitable for axisymmetric problems and proved the best convergence for this kind of problem. The model was three-dimensional and had the same geometry as it is presented in the Fig. 1. Flow in the suction tube between the suction slot and the recovery nozzles,

primary nozzle, primary flow supply tube with the inlet from the stilling chamber and a short part of the outflow pipe were simulated too, see Fig. 2.

The grid size was 1.24 million of hexahedral cells. The fluid was air considered as ideal gas. Pressure inlets were used for definition of inlet boundary conditions, pressure outlet was used at the ejector exit. Values of temperatures and pressures on boundaries were taken from experiment. Model with slot opening of 1 (mm) was investigated numerically and compared with experiments.

### C. Evaluation of Efficiency

For evaluation of ejector efficiency, we used equations

$$\eta = \frac{m_2}{m_1} \frac{\left(\frac{p_4}{p_{02}}\right)^{\frac{\kappa-1}{\kappa}} - 1}{1 - \left(\frac{p_4}{p_{01}}\right)^{\frac{\kappa-1}{\kappa}}} \frac{T_{02}}{T_{01}} \approx \frac{m_2}{m_1} \frac{p_4 - p_{02}}{p_{01} - p_4}, \quad (1)$$

where  $T_0$  is stagnation temperature,  $p_0$  stagnation pressure,  $p$  static pressure,  $m$  mass flow rate,  $\kappa$  ratio of specific heats, 1 denotes conditions of primary air, 2 of the secondary air and 4 condition behind the diffuser. The first term in (1) is for compressible fluid and the second one for incompressible. Both terms can be used, because the Mach number is lower than 0.15 and stagnation temperatures are equal:  $T_{01} = T_{02}$ . As we can see from (1), the kinetic energy behind the ejector is considered as a loss. Similarly we used these two equations to

evaluate static pressure recovery coefficient of the diffuser

$$C_p = \frac{m_4}{m_3} \frac{1 - \left(\frac{p_3}{p_4}\right)^{\frac{\kappa-1}{\kappa}}}{1 - \left(\frac{p_3}{p_{03}}\right)^{\frac{\kappa-1}{\kappa}}} \frac{T_4}{T_{03}} \approx \frac{m_4}{m_3} \frac{p_4 - p_3}{p_{03} - p_3} \quad (2)$$

where 3 denotes conditions behind the mixing chamber. The difference between  $m_3$  and  $m_4$  is mass flow rate through the suction slot. The theoretical maximal static pressure recovery coefficient without suction is computed from enlargement of the diffuser as

$$C_{p_{ideal}} = 1 - \frac{1}{\mu_D^2} = 1 - \left(\frac{A_3}{A_4}\right)^2 \quad (3)$$

and for our case is 0.899. The diffuser effectiveness or diffuser efficiency is simply the relationship between the actual recovery and the ideal recovery

$$\eta_D = C_p / C_{p_{ideal}} \quad (4)$$

The problem while computing actual pressure recovery is to evaluate properly dynamic pressure in the diffuser inlet  $p_{d3}$ . We computed it simply from mass flow rate by using equation

$$p_{d3} = \frac{\rho_3}{2} \left( \frac{4m_3}{\pi D^2 \rho_3} \right)^2 \quad (5)$$

where  $D$  is diameter of the mixing chamber.

### III. RESULTS AND DISCUSSION

#### A. Ejector Performance

Numerical results and comparison with experiments are presented in Fig. 3 - 10. The results obtained numerically for ejector with diffuser with divergence angle of  $40^\circ$  and slot opening of 1 (mm) will be compared with experimental investigation of the same diffuser configuration, also with the same diffuser with slot opening of 0 (mm) – slot is closed – and finally with experimental investigation of ejector with common diffuser with divergence angle of  $6^\circ$  made by Dvorak and Dancova in work [15].

The ejector efficiency is plotted as a function of ejection ratio, i.e. ratio of mass flow rates  $m_2/m_1$  in Fig. 3. It was found out during experimental investigation [14] that the ejector with  $40^\circ$  diffuser without suction through slot of width of 0 (mm) had the lowest efficiency. The efficiency was increased slightly by applying the boundary layer suction through the slot and the highest efficiency was found out for narrowest slot of width of 0.5 (mm) and efficiency decreased with wider opening of the suction slot. There is also comparison with results obtained on the same ejector with  $6^\circ$  diffuser [15] in

the figure and comparison with numerical results obtained with Fluent for divergence angle of  $40^\circ$  and suction slot 1 (mm). As we can see, the agreement between the experimental and numerical data is not perfect and the efficiency is lower for numerical calculation using Realizable  $k-\epsilon$  turbulence model.

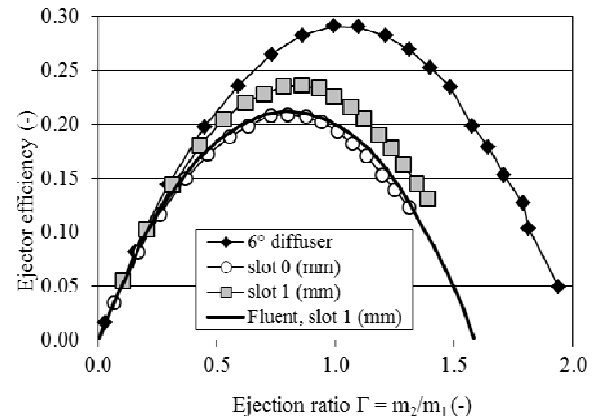

Fig. 3 Ejector efficiency obtained experimentally and numerically for different configuration of the diffuser of the ejector

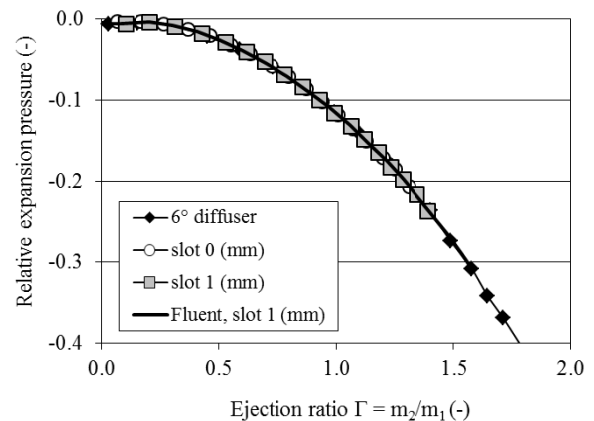

Fig. 4 Relative expansion pressure  $(p_{12} - p_{02}) / (p_{01} - p_{02})$  in the beginning of the mixing chamber for different configuration of the diffuser of the ejector

Results of pneumatic measurements and numerical computation of expansion pressure  $p_{12}$  are in Fig. 4. As we can see, the slot opening and design of the diffusers have no influence on pressure  $p_{12}$ . The expansion pressure  $p_{12}$  is measured and evaluated in the beginning of the mixing chamber and is fully determined by ejection ratio. The boundary layer suction and return of the fluid into the mixing chamber behind the point, where the expansion pressure is measured, cannot influence it. Also results of numerical investigation agree well with experiments, i. e. expansion of both flows is predicted precisely.

As we can see further in Fig. 5, the mixing pressure  $p_3$  measured and evaluated numerically at the end of the mixing chamber, i.e. in the diffuser inlet upstream the suction slot, was affected by boundary layer suction only slightly. When

the suction was applied, the mixing chamber decreased and was lower for the same ejection ratio. It is most likely caused by additional fluid which flew through the mixing chamber and thus the dynamic pressure  $p_{d3}$  was increased and the static pressure  $p_3$  decreased. The differences between experiment and numerical calculation are obvious only for higher ejection ratios where the numerically predicted expansion pressure is lower.

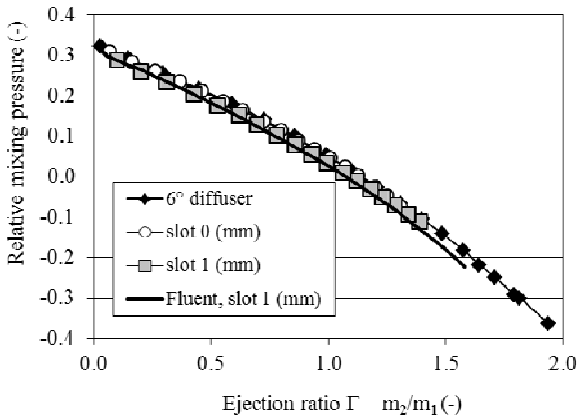

Fig. 5 Relative mixing pressure  $(p_3 - p_{02}) / (p_{01} - p_{02})$  at the end of the mixing chamber for different configuration of the diffuser of the ejector

Investigation of back pressure as a function of ejection ratio in Fig. 6 showed that the main differences in flows are in diffusers. The highest back pressures were measured while diffuser with divergence angle of 6° was applied and lowest with 40° diffuser without suction. According to the relation (1), obtained back pressure is crucial for ejector efficiency for given ejection ratio. For ejection ratio lower than 0.4, the diffuser with applied suction had comparable performance as 6° diffuser. Also here, the numerically evaluated back pressure is lower for higher ejection ratios.

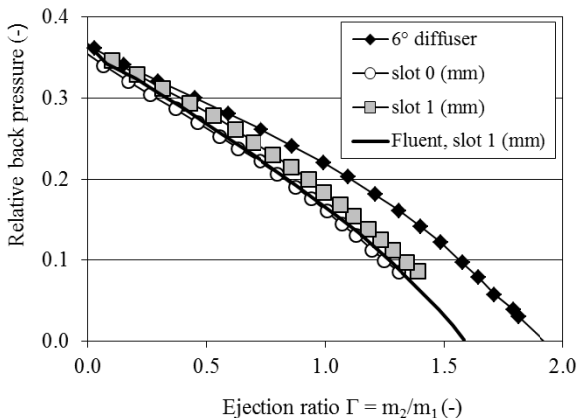

Fig. 6 Relative back pressure  $(p_4 - p_{02}) / (p_{01} - p_{02})$  behind the diffuser for different configuration of the diffuser of the ejector

### B. Diffuser Effectiveness

The effectiveness of the diffuser itself is plotted in Fig. 7. There is diffuser effectiveness computed from back pressure measured 300 mm (4.2 tube diameters) behind the diffuser exit. It is sufficient to ensure finished deceleration of flow and insignificant effect of friction, as was found out by Dvorak in [14]. The diffuser effectiveness for diffuser with divergence angle of 40° is only 0.6 whereas it is above 0.9 for diffuser with divergence angle of 6°. With the boundary layer suction, the diffuser efficiency increased on values between 0.7 and 0.84, but numerically calculated efficiency is significantly lower.

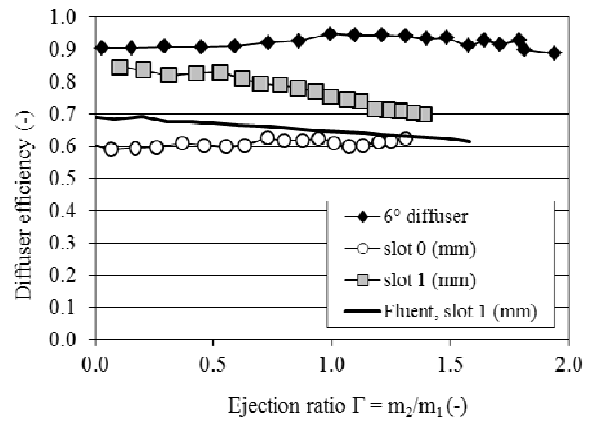

Fig. 7 Diffuser efficiency for back pressure measured 300 (mm) behind the diffuser

We can see from Fig. 6 and more in detail in Fig. 7 that the most important differences between results of experimental and numerical investigation occurs while describing flow in the diffuser. Numerically evaluated efficiency of the diffuser is significantly lower than measured. Simply, the measured back pressure is higher than computed for the same ejection ratio. As a result of low diffuser effectiveness the ejector efficiency drops too.

Suction ratios defined by ration of mass flow rates  $(m_3 - m_4)/m_3$  as a function of ejection ratio are in Fig. 8. Suction mass flow rates are mostly given by pressure difference  $p_3 - p_{12}$ , i.e. pressure difference between the suction slot and recovery nozzles, whereas the width of the slot opening was not so important. This pressure difference decreases with higher ejection ratio, but this is not the only one influencing factor. As we can see, diffusers efficiency is high for high pressure difference, high suction ratio, low ejection ratio and also fast mixing. Numerically predicted curve of suction ratio decreases more slowly with higher ejection ratio.

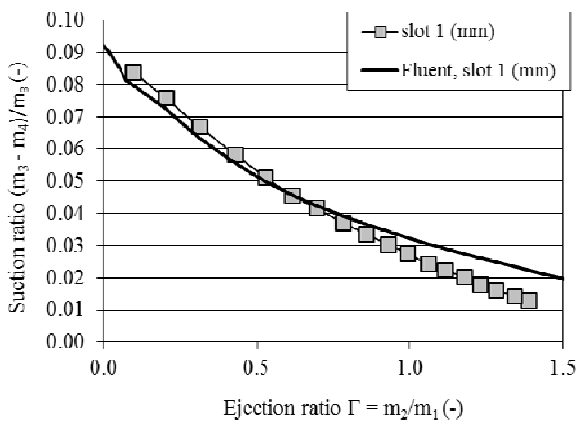

Fig. 8 Suction ratio for various ejection ratio

Resulting diffuser effectiveness as a function of suction ratio is plotted in Fig. 9. There is also comparison with results published by Furuya et al. [5] for 40° diffuser. It follows from results in Fig. 9 that the influence of the boundary layer suction on diffuser efficiency is significant. We can see in Fig. 9 that the diffuser efficiency increases until suction ratio is 0.06 and then remains constant or increases only negligibly. Unfortunately these suction ratios are obtained only for ejector regimes of low ejection ratio, as it is obvious from Fig. 8. For higher ejection ratios, the back pressure is lower and also pressure difference  $p_3 - p_{12}$  is lower and suction ratio decreases rapidly below sufficient values.

Prediction of numerical calculation is rather poor.

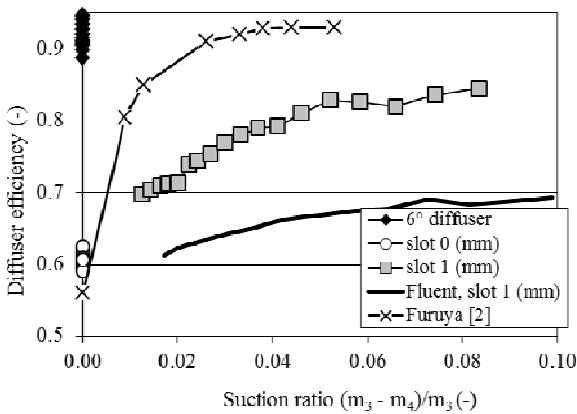

Fig. 9 Diffuser efficiency as a function of suction ratio

### C. Static Pressure Distribution

The static pressure distribution on the mixing chamber wall was measured and evaluated numerically to investigate the effect of boundary layer suction and returning of sucked fluid back to the mixing chamber. Static pressure distributions in the mixing chamber, diffuser and tube behind the diffuser are in Fig. 10. Static pressure was measured in two positions behind the diffuser, 30 and 300 (mm). Regimes with similar expansion and mixing pressure  $p_{12}$  and  $p_3$  respectively were chosen to illustrate influence of different configuration of the

diffuser of the ejector. Fig. 10a shows flow in ejector for low back pressure and ejection ratio approximately equal to 1.3. The static pressure rise is low in the mixing chamber for this regime, whereas the mass flow rate as well as dynamic pressure  $p_{d3}$  is high, and therefore the pressure rise in diffusers is correspondingly high as well.

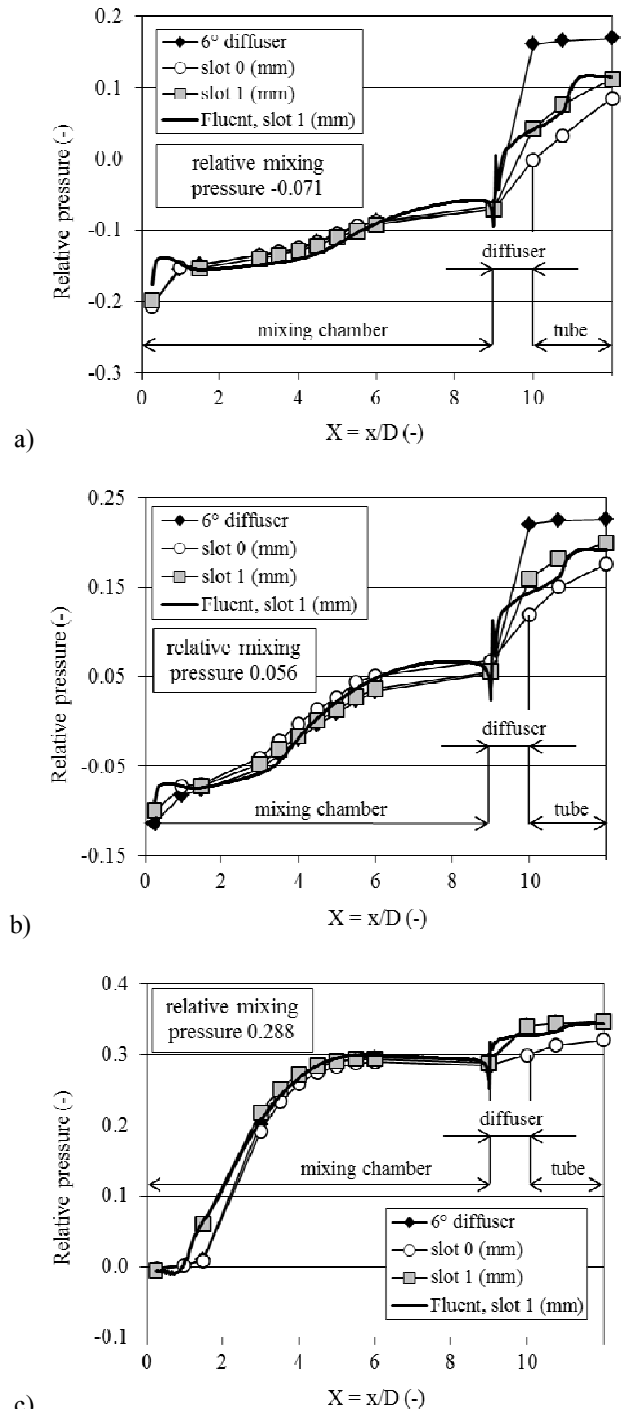

Fig. 10 Static pressure distribution on the mixing chamber wall, diffuser and tube behind the diffuser for three values of mixing pressure. Relative pressure is defined as  $(p - p_{02}) / (p_{01} - p_{02})$ .  $X = x/D$  is dimensionless axial coordinate

We can observe from Fig. 10a that only 47% of the static pressure rise was realized in the 40° diffuser without suction itself, whereas it was 56% with suction and 96% for 6° diffuser.

Fig. 10b presents results for regime with ejection ratio of 0.9. Here, the static pressure rise was bigger in the mixing chamber and pressure rise in diffusers decreased. Finally, Fig. 10c shows static pressure distributions for regime with high back pressure and ejection ratio of 0.2. The static pressure rise in the mixing chamber and also the pressure difference  $p_3 - p_{12}$  were high for this regime and diffuser with suction reached the highest efficiency. Here, 85% of the static pressure rise was realized in 40° diffuser with suction whereas it was only 45% without suction. Static pressure distributions presented in Fig. 10 again confirm that the main and dominant differences in flow throughout the whole ejector occur in the diffuser, which is the crucial part of the ejector.

There are differences of static pressure rise between cases with and without boundary layer suction in Fig. 10c. It seems that the mixing processes are faster for low ejection ratio with boundary layer suction and that the flow from recovery nozzles enhanced the mixing. Also numerical calculation which is in good agreement in this case, proved this.

#### D. Numerical Investigation

Results of numerical calculation of flow in the ejector and diffuser with slot for boundary layer suction are in Fig. 11 and 12. There are contours of axial velocity (component x) in the inlet part of the ejector in Fig. 11. Three different regimes are presented, relative mixing pressures as the same as in Fig. 10.

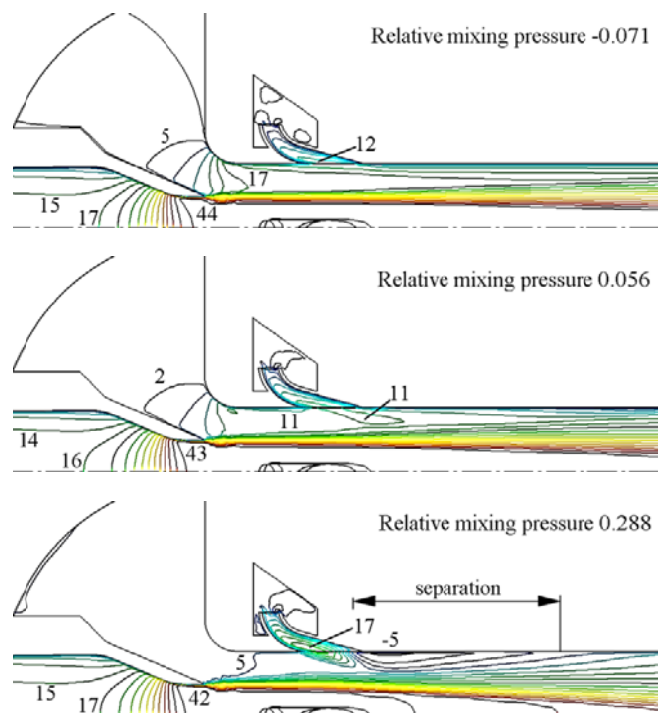

Fig. 11 Contours of axial velocity in the inlet part of the ejector

The first regime is for low back pressure and relative

mixing pressure of -0.071. Here, the velocity from recovery nozzles is lower than it is in the mixing chamber. The sucked fluid, which is returned to the mixing chamber, must be accelerated again. It causes additional losses caused by mixing process and the thickness of the boundary layer in the mixing chamber is increased. The flow in the exit of recovery nozzles is not ideal, because the exit cross sections of the recovery nozzles are confined by faster flow in the mixing chamber.

The second regime is for middle back pressure and relative mixing pressure of 0.056. The velocity in the mixing chamber is almost equal to the velocity from recovery nozzles. The returning fluid affects the flow in the mixing chamber only slightly, due to the increase of mass flow rate the total flow is accelerated. This causes higher frictional losses in the mixing chamber.

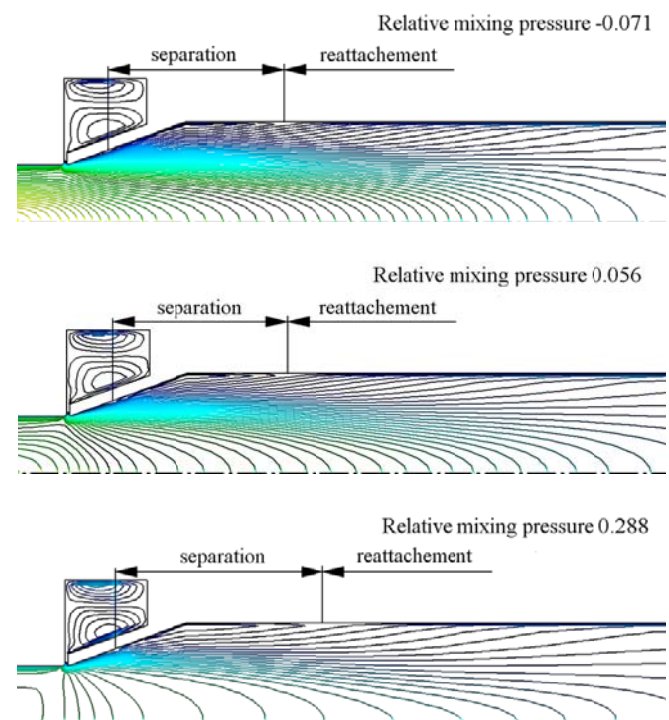

Fig. 12 Contours of axial velocity in the diffuser part of the ejector

The third regime is for high back pressure, low ejection ratio, low secondary fluid and mixing pressure of 0.288. The velocity from recovery nozzles is much higher than the velocity of the main flow. A flow separation occurs behind the recovery nozzles exits. This separation is caused by high adverse pressure gradient which results from fast mixing due to low ejection ratio. It occurs commonly in constant area mixing chambers and extends around the whole mixing chamber. While the boundary layer suction is applied, the flow from recovery nozzles affects this separation positively and reduces it. There are four small flow separation areas just behind the recovery nozzles exits, whereas the flow does not separate in places between. The mixing process is affected positively for this regime and according to the static pressure distribution in Fig. 11c it is even faster.

There are contours of axial velocity in the diffuser part of the ejector in Fig. 12. Again the same three different regimes as in Fig. 10 and 11 are presented. There are the end of the mixing chamber, the diffuser, the suction slot with suction chamber, and short entrance part of the exit tube visible in Fig. 12.

A flow separation in the diffuser is visible and marked in the figure. It seems that the separation occurs further downstream the diffuser for higher mixing pressure, but the dependency is indistinctive. The flow separation is longer and the flow reattaches back to the wall further downstream for higher mixing pressure. The point of reattachment is also marked in the figure.

#### IV. CONCLUSION

The effect of boundary layer suction in the inlet of diffuser with divergence angle of  $40^\circ$  on flow in ejector was investigated experimentally and numerically. Both diffuser and ejector efficiency were evaluated. It was found out that boundary layer suction can improve efficiency of the diffuser and thereby of the whole ejector significantly. The suction ratio is dependent on the regime of the ejector, i.e. on the ejection ratio. The diffuser efficiency increases for higher suction ratio and remains almost constant if it is greater than 0.06. Therefore, the suction is inefficient for low backpressures and high ejection ratios of the ejector.

Static pressure distributions on the mixing chamber wall were measured and evaluated numerically and it seems that sucked fluid which is returned to the mixing chamber enhances the mixing only for regimes with high back pressures and mixing pressures.

The numerical modeling brought more detailed view into the problem. Nevertheless, the agreement between the experimental and numerical investigations had substantial limits. We used turbulence model Realizable k- $\epsilon$ , which described satisfactorily the inlet part of the ejector, flow in nozzles and mixing processes. Also the prediction of suction ratio agreed well with measuring. Precision of numerical computation is poor while describing flow in the diffuser especially for regimes of ejector with high ejection ratios and low back pressure.

In the next work we will focus on optimization of the ejector configuration that can yield higher ejector efficiency. It seems that bigger recovery nozzles would be beneficial. Also replacement of the suction slot further downstream the diffuser can solve the problem with low pressure difference of high ejection ratio regimes. The improvement of agreement between the numerical and experimental data will be crucial for next research.

#### REFERENCES

[1] J. H. Keenan, E. P. Neumann and F. Lustwerk, "An Investigation of Ejector Design by Analysis and Experiment," *Journal of Applied Mechanics, Trans ASME, 1950, 72*, pp. A75–A81.  
[2] D. W. Sun and I. W. Eames, "Recent Developments in the Design Theories and Applications of Ejectors – a review," *Journal of the Institute of Energy, 1995*, pp. 65–79.

[3] J. L. Porter, R. A. Squyers, "A Summary/Overview of Ejector Augmentor Theory and Performance," ATC Report No. R-91100/9CR-47A, *Vought Corp Advanced Technology Cr, Dallas, Texas, 1981*.  
[4] D. Japikse, N. C. Baines, *Diffuser Design Technology*, Concepts ETI, Inc., USA 1998.  
[5] Y. Furuya, T. Sato, T. Kushida, "The loss of flow in the conical diffusers with suction at the entrance," *Bull JSME 9(33), 1966*, pp. 133–136.  
[6] T. T. Yang, W. G. Hudson, C. D. Nelson, "Design and experimental performance of short curved wall diffusers with axial symmetry utilizing slot suction," *NASA CR-2209, 1973*.  
[7] D. O. Rockwell, "Flow fields in a two-dimensional diffuser with extraction of fluid on the diverging walls," *Trans ASME Journ Eng Power 94, 1972*, pp. 226–232.  
[8] R. E. Anderson, "The effect of boundary layer suction on the efficiency of the diffuser of a jet ejector," *Thesis, The University of Texas, 1958*.  
[9] B. S. Riffat, G. Gan, S. Smith, "Computational Fluid Dynamics Applied to Ejector Heat Pumps," *Applied Thermal Engineering Vol. 16, No. 4, 1996*, pp. 291–297.  
[10] E. Rusly, Lu Aye, W. W. S. Charters, A. Ooi, "CFD Analysis of Ejector in a Combined Ejector Cooling System," *International Journal of Refrigeration 28, 2005*, pp. 1092–1101.  
[11] V. Dvorak, "Optimized Axi-Symmetric Ejector – Experimental and Numerical Investigation," *Experimental Fluid Mechanics 2009, Liberec 25. – 27. November 2009*, pp. 34–43.  
[12] Y. Bartosiewicz, Z. Aidoun, P. Desevaux, Y. Mercadier, "Numerical and experimental investigations on supersonic ejectors," *International Journal of Heat and Fluid Flow 26 (2005)*, pp. 56–70.  
[13] J. Simak, "Computation of the Flow and Interaction of Shock Waves in a 2D Supersonic Ejector", *Colloquium Fluid Dynamics 2009, Institute of Thermomechanics AS CR, v.v.i., Prague, Czech Republic, October 21 – 23, 2009*.  
[14] V. Dvorak, "Air ejector with diffuser with boundary layer suction", to be published in *Engineering Mechanics, Brno, Czech Republic, 2013*.  
[15] V. Dvorak, P. Dancova, "An Investigation into Air Ejector with Pulsating Primary Flow", *World Academy of Science, Engineering and Technology, issue 81, September 2011*, pp. 601–607.