

# An Energy Efficient Cluster Formation Protocol with Low Latency In Wireless Sensor Networks

A. Allirani, and M. Suganthi

**Abstract**—Data gathering is an essential operation in wireless sensor network applications. So it requires energy efficiency techniques to increase the lifetime of the network. Similarly, clustering is also an effective technique to improve the energy efficiency and network lifetime of wireless sensor networks. In this paper, an energy efficient cluster formation protocol is proposed with the objective of achieving low energy dissipation and latency without sacrificing application specific quality. The objective is achieved by applying randomized, adaptive, self-configuring cluster formation and localized control for data transfers. It involves application - specific data processing, such as data aggregation or compression. The cluster formation algorithm allows each node to make independent decisions, so as to generate good clusters as the end. Simulation results show that the proposed protocol utilizes minimum energy and latency for cluster formation, there by reducing the overhead of the protocol.

**Keywords**—Sensor networks, Low latency, Energy sorting protocol, data processing, Cluster formation.

## I. INTRODUCTION

THE exploitation of minute, economical, low-power, distributed devices has been made a reality owing to the modern technical development that is competent of local processing and wireless communication. These types of nodes are called as sensor nodes. Only a restricted amount of processing is allowed in every sensor node. However, these nodes illustrate the capability to gauge a provided physical environment in great detail when synchronized with the information from a massive amount of other nodes. A sensor node coordinating to carry out a few definite actions is characterized by employing a collection of consequent sensor nodes. In contrast to the traditional networks, so as to accomplish its responsibilities, the sensor networks depend on dense deployment and co-ordination.

In the early days, the sensor networks comprised of a few number of sensor nodes wired to a central processing station. Nonetheless, the focus on these days has shifted to wireless, distributed sensing nodes. Yet, it is important to know the necessity of distributed, wireless sensing [1]. Provided that the accurate location of a particular phenomenon is unfamiliar, the distributed sensing permits closer placement to the phenomenon when compared with that a particular sensor.

A.Allirani is with Sona College of Technology, Salem, Tamilnadu, India (off. phone:0427 4099777; fax: 0427 4099888; e-mail:allirani2004@gmail.com).

M.Suganthi,Professor,Department of electronics and communication engineering,Thiyagarajar College of Engineering, Madurai, Tamilnadu, India (e-mail:msuganthi@tce.edu).

Moreover, in order to overcome ecological impediments like obstructions, line of sight constraints etc. in several cases multiple sensor nodes are necessary. The observed environment does not possess an offered infrastructure in the majority cases of energy or communication. Thus necessitating the sensor nodes to stay alive on minute, finite sources of energy and communicating through a wireless communication channel [2].

The distributed processing capability is possibly an added requisite in case of sensor networks, which is vital as communication is a primary consumer of energy. In case of the centralized system, additional energy depletion is caused owing to the necessity for a number of sensors to communicate over long distances. Processing as much information as achievable in the neighborhood would be an excellent thought as this reduces the total quantity of bits broadcasted.

Sensor networks are employed by various applications, for instance: Environmental monitoring is an application, in which monitoring of air, soil and water, condition based maintenance is dealt with. Habitat monitoring is another application, in which the plant and animal species population and behavior are determined. It is worthy to mention seismic detection, military surveillance, inventory tracking, smart spaces etc. Indeed the sensor networks have the potential to incredibly transform the complex physical system is understood and built owing to the enveloping character of micro-sensors [3].

A micro-controller, a radio transmitter, and an energy source are comprised in the sensor. The three essential functions of a sensor network are sensing, communicating and computation. The above mentioned basic functions are implemented using the corresponding basic components hardware, software and algorithms. All the three functions require energy, in which communication requires more energy when compared to the other two functions. Thus, it is necessary to implement a power conscious approach for the micro sensor network algorithms and protocols, in which the energy usage is scaled in accordance with the given quality specification [4].

Hence, proper energy efficient communication protocols should be designed to increase the lifetime of the network greatly. In this paper, an energy efficient clustering protocol (EECFP) is proposed for wireless micro sensor networks to facilitate the achievement of low energy dissipation and latency without sacrificing the application specific quality. From the simulation results, it is illustrated that the EECFP achieves an order of magnitude increase in system lifetime

when compared to the general – purpose approaches. Moreover, for a given quality, the overall latency is reduced by an order of magnitude.

This paper is organized as follows. Section II gives the detailed related work done. Section III presents the system model for our architecture. Section IV gives the experimental results and section V concludes the paper.

## II. RELATED WORK

In MTE routing [5], the author performs the selection of routes from each node to the base station such that each node's next-hop neighbor is the closest node that is in the direction of the base station. In order to determine its next-hop neighbor every node requires 100 nJ. In case a node dies, all of that node's upstream neighbors (i.e., all the nodes that send their data to this node) initiate to transmit their data to the node's next – hop neighbor. Consequently, the need to compute the new routes is eliminated each time a node dies.

The transmit power of the nodes are adjusted to the minimum necessary to reach their next – hop neighbor, by which interference with other transmissions and the node's energy dissipation is reduced. A CSMA MAC protocol is employed to communicate with the next – hop neighbor and the data are dropped when collisions occur. The data received by the node from one of its upstream neighbors is forwarded to its next-hop neighbor. This continues until the base station receives the data.

In LEACH [6], the authors discuss an energy efficient algorithm. Various algorithms developed after that is based on this algorithm. In order to determine the cluster head, LEACH uses randomization technique. In case of the discussed algorithm, after each cycle or after certain time interval, sensors elect themselves to be local cluster – heads, with a certain probability. Subsequently, the status of these cluster heads is broadcasted to the other sensors in the network. Next, each sensor node determines to which cluster it wants to belong. This is done by selecting the cluster – head for which minimum communication energy is required.

After the organization of all the nodes into clusters, a schedule is created by each cluster-head for the nodes in its cluster, according to which the radio components of each node is allowed to be turned off at all times except in its transmit time. Hence, minimizing the energy dissipated in the individual sensors. After receiving all the data from the nodes in its cluster, the cluster-head node aggregates the data and then transmits the compressed data to the base station. The energy necessary for this transmission is more due to the fact that the base station is far away from the area in which the sensors are deployed. Nonetheless, only a small number of nodes are affected as there are only a few cluster-heads. In case of the discussed algorithm, the node that acts as a cluster head can not become a cluster head prior to the completion of a predetermined time cycle and to form a cluster the position of the sensors is not essential.

In the initial stage of LEACH-C [7] algorithm, each node sends information to the base station. The information is about current location and energy level of that node. An

optimization algorithm is run by the base station to determine the clusters for that round. Hence the position of each node at the beginning of each round is necessitated by this algorithm. This necessitates a global positioning system, GPS. The average node energy is calculated by the base station. The nodes having energy below this average cannot become cluster heads for the current round. In order to determine the best nodes to be cluster heads for the next round and the associated clusters, the base station uses the remaining nodes as possible cluster heads and runs an algorithm known as simulated annealing algorithm, which is based on thermodynamics principles.

According to LEACH-F algorithm [7], the clusters are fixed and only the cluster heads are rotated. In this case, when another cluster's cluster head is nearer, large amount of power is required by a node to communicate with its cluster head. LEACH\_F employs the same annealing algorithm for initial cluster formation as in LEACH\_C. When compared to LEACH\_C, the discussed algorithm is more energy efficient. However, due to the reason that the discussed algorithm does not allow new nodes to be added to the system and does not adjust its behavior based on nodes-dying and high interference of signals, this algorithm cannot be implemented in practical real time systems. In addition, node mobility is not handled by LEACH\_F.

Ewa Hansen et al., [8] have presented simulation results from the experiments with a minimum separation distances between cluster heads. They also determine how much the amount of energy consumption can be lowered in the sensor network by separating the cluster heads, i.e., by distributing the cluster heads through the whole network. A simple energy-efficient cluster formation algorithm for the wireless multihop sensor network AROS has been presented which demonstrates that using a minimum separation distance between cluster heads improves energy efficiency. The energy efficiency is measured by the number of messages received at the base station. A comparison of employing the minimum separation between the cluster heads with not employing the minimum separation between the cluster heads is performed, in which it is illustrated that the performance of employing the minimum separation between the cluster heads is better up to 150%.

A distributed, energy-efficient clustering approach for ad-hoc sensor networks has been presented by Ossama Younis and Sonia Fahmy [9]. The discussed approach is hybrid: the selection of cluster heads are made probabilistically based on their residual energy and nodes join clusters such that communication cost is minimized. Here, the authors assumed the quasi-stationary networks (nodes are location-unaware and having equal significance). The presented approach exploits the availability of multiple transmission power levels at sensor nodes, which is a key aspect of the presented approach. The authors have introduced the HEED protocol on the basis of the discussed approach. This protocol is independent of network diameter and terminates in a constant number of iterations.

S.Lindsey and C.S.Raghavendra [10] discuss a greedy chain protocol, PEGASIS that is near optimal for a data-gathering problem in sensor networks. PEGASIS eliminates the

overhead of dynamic cluster formation, minimizes the distance non leader-nodes must transmit, limits the number of transmissions and receives among all nodes, and uses only one transmission to the BS per round. Due to the above features, PEGASIS outperforms LEACH. The fused data are transmitted by the nodes (in turns) to balance the energy depletion in the network and robustness of the sensor web is preserved as nodes die at random locations. The lifetime and quality of the network is increased by distributing the energy load among the nodes.

A novel, distributed energy efficient and load balanced clustering scheme has been presented in Mao Ye et al., [11] intended for periodical data gathering. EECS produces a uniform distribution of cluster heads across the network through localized communication with little overhead. Additionally, the authors discuss a novel approach that distributes the energy consumption among the sensors in the cluster formation phase. It can be observed from the simulation results that EECS prolongs the network lifetime as much as 135% of LEACH and the consumption of total energy is efficient.

The authors, Hang Su and Xi Zhang [12] have derived the optimized parameter – the number of clusters – for BCCA by extending the existing analytical model and its correctness is illustrated by simulations. The fact that the original analytical model underestimates the optimal number of clusters and thus necessitates modification is revealed by the analysis performed by the authors. The analysis is verified by the simulation results, which illustrates the modified model was more accurate in deriving the optimal number of clusters to maximize the lifetime of wireless sensor networks.

The authors, M. J. Handy, M. Haase and D. Timmermann [13] have discussed two modifications of LEACH's cluster-head selection algorithm, which accomplishes a 30 % increase of lifetime of micro sensor networks. Despite the modifications, an important quality of a LEACH network is sustained in addition, which is the necessity of only local information rather than global information for the deterministic selection of cluster-heads. The determination whether nodes become cluster-heads is performed by the nodes itself, which does not require the communication with the base station or an arbiter-node. In addition, they have presented the metrics FNA, HNA and LND which describe the lifetime of a micro sensor network.

Ameer Ahmed Abbasi and Mohamed Younis have surveyed different clustering algorithms for WSNs, highlighted their objectives, features, complexity, etc. They also compared the clustering algorithms based on metrics such as convergence rate, cluster stability, cluster overlapping, location awareness and support for node mobility [14].

The authors Antoine B. Bagula and Kuzamunu G. Mazandu have addressed the issues of Quality of Service (QoS) Routing to improve energy consumption in wireless sensor networks (WSNs). Building upon a previously proposed QoS provisioning benchmark model, they formulated the problem of routing sensed information in a WSN network as a path-based energy minimization problem subject to QoS routing

constraints expressed in terms of reliability, delay and geospatial energy consumption. Using probabilistic approximations, they transformed the path-based model into a link-based model and applied methods borrowed from the zero-one optimization framework to solve the problem [15].

Guojun Wang, et al., have proposed a local update-based routing protocol in WSNs with a mobile sink. The protocol proposed by the authors saves the energy for sensor networks and makes the sink keep continuous communications to sensors by confining the destination area into a local area for updating the sink location information as the sink moves. Compared with protocols that need to continuously propagate the sink's location information among the entire network, LURP greatly decreases the cost of updating the sink's location information and decreases the collisions in wireless transmissions. In addition, when the sink moves out of its destination area, those sensors which are far away from the sink can still communicate with it without receiving the new location information of the sink. Therefore, the protocol proposed by the authors reduces the delay and energy consumption which is suitable for large-scale and delay-sensitive wireless sensor networks [16].

Hayoung Oh and Kijoon Chae have presented a sensor routing scheme, EESR (Energy-Efficient Sensor Routing) that provides energy-efficient data delivery from sensors to the base station. Their scheme divides the area into sectors and locates a manager node to each sector. The manager node receives collected data from sensor devices in its corresponding sector and then transfers the data to the base station through the shortest path of the 2-dimensional (x, y) coordinates. In this process, they used relative direction based routing in the 2-dimensional (x, y) coordinates in wireless sensor networks. They have also shown that their proposed scheme achieve significant energy savings and outperforms idealized transitional schemes (e.g., broadcasting, directed diffusion, clustering) under the investigated scenarios [17].

### III. THE ENERGY EFFICIENT CLUSTER FORMATION PROTOCOL (EECFP) ARCHITECTURE

An Energy Efficient Cluster Formation Protocol (EECFP) has been designed and implemented in this paper. EECFP is a protocol architecture for wireless micro sensor networks that achieves low energy dissipation and latency, provided that the application – specific quality is not sacrificed. The nodes can collaborate locally to reduce the data that needs to be transmitted to the end – user owing to the reason that the data are correlated and the end – user only requires a high – level description of the events occurring in the environment the nodes are sensing. Correlation is strongest among data signals from nodes that are close to each other, by which the use of a clustering infrastructure that allows nodes that are close to share data is suggested. Hence a clustering architecture is employed by EECFP, in order to send the data in the nodes in the cluster to a local cluster – head, which is responsible for receiving all the data from nodes within the cluster and the aggregation of this data into a smaller set of information that describes the events the nodes are sensing. Hence, a number of

data signals are taken and the *actual* data (total number of bits) is reduced, while the *effective* data (information content) is maintained by the cluster head node, which must then send the aggregate data set to the end-user [6].

One of the sensor nodes must take on the role of a cluster-head owing to the reason that there may be no fixed infrastructure with a high – energy node that can act as a cluster – head. In case this position was fixed, the cluster – head would quickly use up its limited energy and die, which ends the communication ability of the rest of the nodes in the cluster as well. In order to evenly distribute the energy load, EECFP includes rotation of this cluster–head position among all the nodes in the network. The cluster formation algorithm must ensure minimum overhead, in terms of time and energy with the aim of rotating cluster–head nodes and associated clusters. After the formation of the clusters, the nodes must communicate their data to the cluster – head node efficiently with respect to energy consumption.

EECFP therefore uses the following techniques to exploit the application – specific functionality of a sensor network and achieve energy and latency efficiency

- (i) randomized, adaptive, self - configuring cluster formation,
- (ii) localized control for data transfers, and
- (iii) Application - specific data processing, such as data aggregation or compression.

The cluster formation algorithm allows each node to make autonomous decisions that result in good clusters being formed. This algorithm also minimizes the energy and latency for cluster formation, in order to minimize overhead to the protocol. Finally, local data processing achieves a large energy reduction by performing computation on the correlated data to greatly reduce the amount of data that must be transmitted long distances.

#### A. EECFP Architecture

Currently, there is a great deal of research in the area of low – energy radios. Different assumptions about the radio characteristics, including energy dissipation in the transmit and receive modes, will change the advantages of different protocols. In our work, we assume a simple model where the radio dissipates  $E_{elec} = 50 \text{ nJ / bit}$  to run the transmitter or receiver circuitry and  $\epsilon_{amp} = 100 \text{ pJ / bit / m}^2$  for the transmit amplifier to achieve an acceptable  $E_b / N_o$ . These parameters are slightly better than the current state of the art in radio design. We also assume an  $r^2$  energy loss due to channel transmission. Thus, to transmit a k-bit message a distance d using our radio model, the radio expends:

$$E_{Tx}(k, d) = E_{Tx-elec}(k) + E_{Tx-amp}(k, d)$$

$$E_{Tx}(k, d) = E_{elec} * k + \epsilon_{amp} * k * d^2 \quad (1)$$

and to receive this message, the radio expends:

$$E_{Rx}(k, d) = E_{Rx-elec}(k)$$

$$E_{Rx}(k) = E_{elec} * k \quad (2)$$

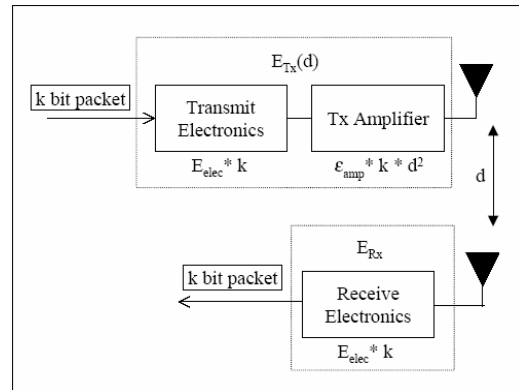

Fig. 1 First order radio model

TABLE I  
 RADIO CHARACTERISTICS

Operation	Energy Dissipated
Transmitter Electronics ( $E_{Tx-elec}$ )	50 nJ / bit
Receiver Electronics ( $E_{Rx-elec}$ ) ( $E_{Tx-elec} = E_{Rx-elec} = E_{elec}$ )	
Transmit Amplifier ( $\epsilon_{amp}$ )	100 pJ / bit / m <sup>2</sup>

The reception of a message for these parameters is an expensive operation and so it is necessary that the protocols attempt to minimize both the transmit distances and the number of transmit and receive operations for each message.

We make the assumption that the radio channel is symmetric such that the energy required to transmit a message from node A to node B is the same as the energy required to transmit a message from node B to node A for a given Signal to Noise Ratio. For our experiments, we also assume that all sensors are sensing the environment at a fixed rate and thus always have data to send to the end-user. For future versions of our protocol, we will implement an “event – driven” simulation, where sensors only transmit data if some event occurs in the environment.

#### B. Different Cycles of EECFP

**First Cycle.** Originally, the data sent to the base station by the nodes are sent to the cluster heads which in turn would consolidate the data and direct them towards the base station. Thus the data is primarily sent to the cluster heads. This can be performed by the nodes only when they possess a certain amount of energy that can be calculated with the aid of radio model. Eventually the energy of the nodes goes down from their initial energies. Later we determine the necessary energy to transmit the consolidated data to the base station by the other cluster heads. The energy thus determined is reduced from the initial energy.

**Consecutive cycles.** All the energies of individual nodes are compared with each other. The top 5 nodes which are having higher energies compared to others are elected as new cluster heads for the consecutive cycles. Now all the steps of cycle are repeated until all the energies of nodes are dried up which is known as death of nodes. The nodes which are alive

after every cycle are calculated. Finally the graph between the number of nodes alive versus number of cycles is plotted.

#### IV. SIMULATION RESULTS

##### A. Simulation Parameters

We evaluate our EECFP scheme through NS2 simulation. We considered a 100 node random network deployed in an area of 100 X 100 m. Initially the nodes are placed randomly in the specified area. The base station is assumed to be situated 100 meters away from the above specified area. We also assume that 5% of nodes are considered as cluster heads for the entire cycles. Obviously, the first set of cluster heads are taken randomly. The initial energy of all the nodes assumed as 0.5 joules. The cluster heads which are closer to every node will act as a cluster head for those nodes for the first cycle. The nodes and the cluster head nearer to those nodes will form a group. Thus we formed 5 groups since we have five cluster heads.

In our simulation, the channel capacity of mobile hosts is set to the same value: 2 Mbps. We use the distributed coordination function (DCF) of IEEE 802.11 for wireless LANs as the MAC layer protocol. The simulated traffic is FTP with TCP source and sink. All experimental results presented in this section are averages of five runs on different randomly chosen scenarios. The following table summarizes the simulation parameters used.

TABLE II  
 SIMULATION PARAMETERS

No. of Nodes	100
Area Size	100 X 100
Mac	802.11
Simulation Time	50 sec
Traffic Source	FTP
Packet Size	512
Transmit Power	0.360 w
Receiving Power	0.395 w
Idle Power	0.335 w
Initial Energy	0.5 J
Transmission Range	75m

##### B. Simulation Results

We compare the performance of our proposed ESP architecture with LEACH [6] and PEGASIS [10]. We evaluate mainly the performance according to the following metrics:

**Average Energy Consumption:** The average energy consumed by the nodes in receiving and sending the packets are measured

**Life time of the network:** The total number of nodes which are alive at end of all cycles of the algorithm.

**Average Throughput:** The average number of packets received at the sink.

**Average Latency:** The average end-to-end latency in receiving the packets at the sink.

##### 1. Effect of Network Life Time for Various Cycles

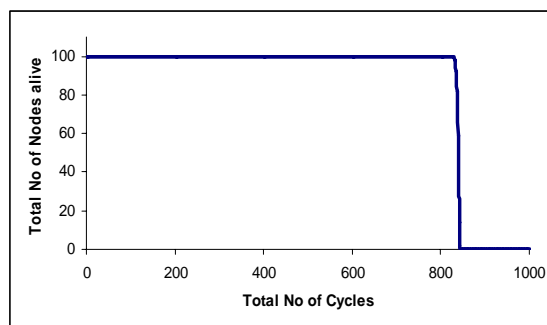

Fig. 2 The life time of the ESP network when initial energies of all nodes are 0.25 J.

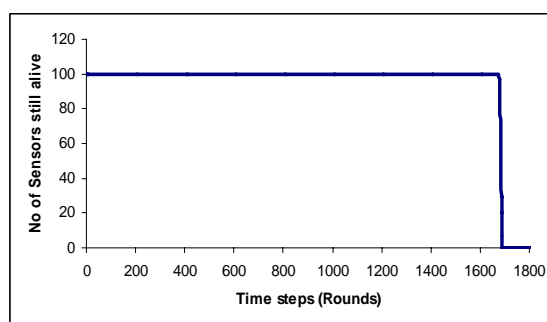

Fig. 3 The life time of the ESP network when the initial energies of all nodes are 0.5 J.

Fig. 2 and 3 shows the life time of the ESP network when the initial energies of all nodes are 0.25 J and 0.5 J respectively.

##### 2. Varying Cluster Size

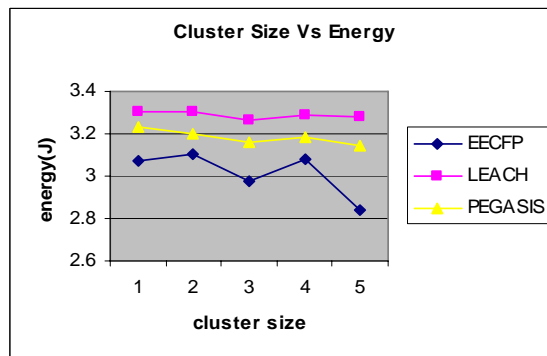

Fig 4 Cluster Size Vs Energy

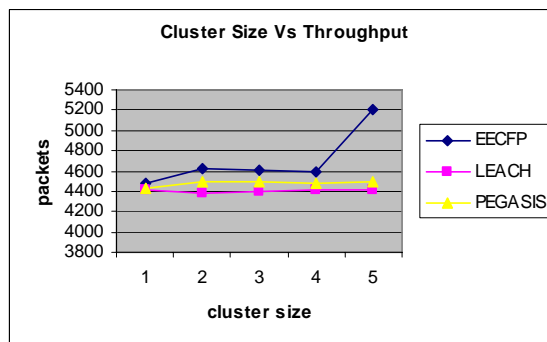

Fig. 5 Cluster Size Vs Throughput

Fig. 4, 5 and 6 shows the average energy consumption, throughput and latency of EECFP, LEACH and PEGASIS, respectively, when the cluster size is increased.. From the figures, we can see that EECFP has less energy consumption, less latency and more throughput when compared to all the other protocols. It can be observed that among the protocols, PEGASIS is next to EECFP. LEACH has the highest energy consumption and latency with low throughput.

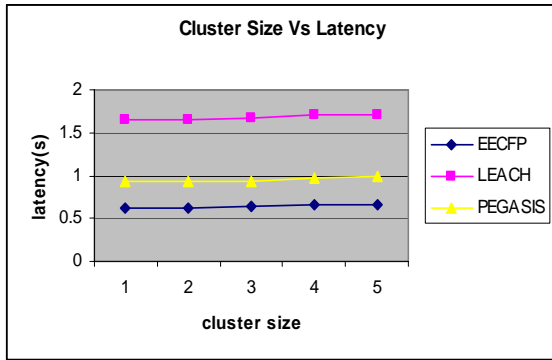

Fig. 6 Cluster Size Vs Latency

### 3. Varying Number of Sources

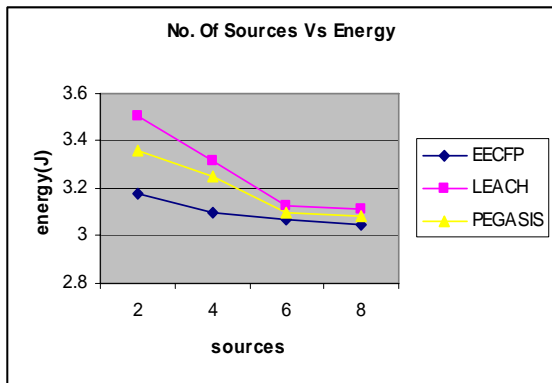

Fig. 7 Sources Vs Energy

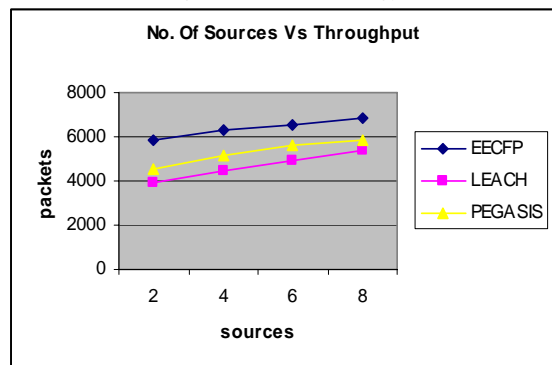

Fig. 8 Sources Vs Throughput

Fig. 7 and 8 shows the average energy consumption and throughput of EECFP, LEACH and PEGASIS respectively, by varying the sources. From the figures, we can see that EECFP has less energy consumption and more throughputs, when compared to LEACH and PEGASIS.

## V. CONCLUSION AND FUTURE WORK

The micro sensor network algorithms and protocols necessitates a power conscious approach, in which the energy usage is scaled in accordance with the given quality specification. Therefore it is necessary to design protocols and algorithms for wireless networks which are bandwidth, and energy – efficient. As a result, proper energy efficient communication protocols should be designed in order to increase the lifetime of the network vastly. This paper proposes an Energy Efficient Cluster Formation Protocol (EECFP), which employs a clustering architecture for wireless micro-sensor networks. It achieves low energy dissipation and latency without sacrificing application specific quality. The simulation results demonstrate that, the EECFP attains an order of magnitude increase in system lifetime. As a future work, the EECFP will be compared against more energy efficient clustering protocols.

## REFERENCES

- [1] Estrin, D. Girod, L. Pottie, G. Srivastava, M., "Instrumenting the world with wireless sensor networks", Proceedings. (ICASSP '01). IEEE International Conference on Acoustics, Speech, and Signal Processing, 2001, Volume: 4, pp: 2033-2036.
- [2] Archana Bharathidasan, Vijay Anand Sai Ponduru, "Sensor Networks: An Overview", IEEE Potentials, April-May 2003, Volume: 22, Issue: 2, pp: 20- 23.
- [3] Deborah Estrin, Ramesh Govindan, John Heidemann, Satish Kumar, "Next Century Challenges: Scalable Coordination in Sensor Networks", Proceedings of the 5th annual ACM/IEEE international conference on Mobile computing and networking, Seattle, Washington, United States, Pages: 263 - 270, 1999
- [4] Wendi Rabiner Heinzelman, Amit Sinha, Alice Wang, and Anantha P. Chandrakasan, "Energy-scalable algorithms and protocols for wireless microsensor networks" Proceedings of the Acoustics, Speech, and Signal Processing, 2000. On IEEE International Conference - Volume 06, pp.3722-3725, 2000
- [5] Juhana Yrjölä, "Energy-Efficient Communication Protocol for Wireless Microsensor Networks", T-79.194 Seminar on theoretical computer science 2005 Algorithmics of sensor networks.
- [6] Wendi Rabiner Heinzelman, Anantha Chandrakasan, and Hari Balakrishnan, "Energy-Efficient Communication Protocol for Wireless Microsensor Networks", Proceedings of the 33rd Hawaii International Conference on System Sciences-Volume 8, Page: 8020, 2000
- [7] Wendi B. Heinzelman et al., "An Application-Specific Protocol Architecture for Wireless Micro sensor Networks", IEEE transactions on wireless communications, vol. 1, no. 4, October 2002.
- [8] Ewa Hansen, Jonas Neander, Mikael Nolin and Mats Björkman, "Energy-Efficient Cluster Formation for Large Sensor Networks using a Minimum Separation Distance", Mälardalen Real-Time Research Centre, Mälardalen University, Sweden, 2006.
- [9] Ossama Younis and Sonia Fahmy, "HEED: A Hybrid, Energy-Efficient, Distributed Clustering Approach for Ad-hoc Sensor Networks", IEEE Transactions on Mobile Computing, Volume 3, Issue 4, October 2004, Pages: 366 - 379
- [10] S. Lindsey, C. S. Raghavendra, "PEGASIS: Power-Efficient Gathering in Sensor Information Systems", in Proceedings of IEEE Aerospace Conference, Vol. 3, March, 2002.
- [11] M. Ye, C. Li, G. Chen, and J. Wu, "EECS: An energy efficient clustering scheme in wireless sensor networks," 24th IEEE International Performance, Computing, and Communications Conference, 2005. IPCCC 2005, 7-9 April 2005 Page(s): 535 - 540
- [12] Hang Su and Xi Zhang, "Energy-Efficient Clustering System Model and Reconfiguration Schemes for Wireless Sensor Networks" IEEE Information Theory Society, the 40th Conference on Information Sciences and Systems (CISS 2006), Princeton University, Princeton, NJ, USA, March 22--24, 2006.
- [13] M. J. Handy, M. Haase, and D. Timmermann, "Low energy adaptive clustering hierarchy with deterministic cluster-head selection", 4th

International Workshop on Mobile and Wireless Communications Network, 2002, pp: 368- 372.

- [14] Ameer Ahmed Abbasi and Mohamed Younis "A survey on clustering algorithms for wireless sensor networks" Computer Communications, Volume 30, Issues 14-15, 15 October 2007, Pages 2826-2841.
- [15] Antoine B. Bagula and Kuzamunu G. Mazandu "Energy Constrained Multipath Routing in Wireless Sensor Networks" Lecture Notes In Computer Science; Vol. 5061, 5th international conference on Ubiquitous Intelligence and Computing Oslo, Norway pages: 453 – 467, Year of Publication: 2008, ISBN:978-3-540-69292-8.
- [16] Guojun Wang , Tian Wang, Weijia Jia, Minyi Guo, Hsiao-Hwa Chen, Mohsen Guizani "Local Update-Based Routing Protocol in Wireless Sensor Networks with Mobile Sinks" This full text paper was peer reviewed at the direction of IEEE Communications Society subject matter experts for publication in the ICC 2007 proceedings.
- [17] Hayoung Oh and Kijoon Chae "An Energy-Efficient Sensor Routing with low latency, scalability for Smart Home Networks" International Journal of Smart Home, Vol. 1, No. 2, July, 2007.



**A. Allirani** is currently working as Prof / Head of Department of Electronics and Communication Engineering in Sona College of Technology, Salem. She graduated her B.E. in Electronics and Communication Engineering (1988) from College of Engineering, Guindy, Chennai and M.E. in Communication Systems (1993) from Regional Engineering College, Tiruchy. She is currently pursuing her Ph.D in the field of Wireless Sensor

Networks at Anna University, Chennai. She has been an educator and administrator in the technical teaching society for the past 19 years.



**M.Suganthi** is currently working as Professor of Department of Electronics and Communication Engineering in Thiyagaraja College of Engineering, Madurai. She graduated her B.E. in Electronics and Communication Engineering from Thiyagaraja College of Engireeing, Madurai, M.E. in Communication Systems from P.S.G College of Technology, Coimbatore, and Ph.D in Mobile Communication from Madurai Kamaraj University,

Madurai. She has been an educator in the technical teaching society for the past 19 years. She has published various papers about the wireless communication in different conferences and journal and she is a registered research guide also.