

Optimization of R507A-R23 Cascade Refrigeration System using Genetic Algorithm

A. D. Parekh, P. R. Tailor, H.R Jivanramajiwala

Abstract—The present work deals with optimization of cascade refrigeration system using eco friendly refrigerants pair R507A and R23. R507A is azeotropic mixture composed of HFC refrigerants R125/R143a (50%/50% by wt.). R23 is a single component HFC refrigerant used as replacement to CFC refrigerant R13 in low temperature applications. These refrigerants have zero ozone depletion potential and are non-flammable. Optimization of R507A-R23 cascade refrigeration system performance parameters such as minimum work required, refrigeration effect, coefficient of performance and exergetic efficiency was carried out in terms of eight operating parameters' combinations using Genetic Algorithm tool. The eight operating parameters include (1) low side evaporator temperature (2) high side condenser temperature (3) temperature difference in the cascade heat exchanger (4) low side condenser temperature (5) low side degree of subcooling (6) high side degree of subcooling (7) low side degree of superheating (8) high side degree of superheating. Results show that for minimum work system should operate at high temperature in low side evaporator, low temperature in high side condenser, low temperature difference in cascade condenser, high temperature in low side condenser and low degree of subcooling and superheating in both side. For maximum refrigeration effect system should operate at high temperature in low side evaporator, high temperature in high side condenser, high temperature difference in cascade condenser, low temperature in low side condenser and higher degree of subcooling in LT and HT side. For maximum coefficient of performance and exergetic efficiency, system should operate at high temperature in low side evaporator, low temperature in high side condenser, low temperature difference in cascade condenser, high temperature in low side condenser and higher degree of subcooling and superheating in low side of the system.

Keywords—Cascade refrigeration system, Genetic Algorithm, R507A, R23,

I. INTRODUCTION

MANY industrial applications require low temperature cooling and high temperature heating simultaneously which cannot be achieved simultaneously and effectively by single stage or multistage systems due to individual limitation of refrigerant. Hence cascade system is the best alternative in these situations. A suitable selection of refrigerants used in HT

and LT cycles can provide a large temperature lift while attaining good system efficiency. A commonly used refrigerants pair in the past has been R12, R502 in high temperature cycle and R13 in low temperature cycle of cascade refrigeration system. These refrigerants have been phased out since 1996 in the developed countries, and should be totally phased out by 2010 in developing countries as per Montreal Protocol and its amendments from the United Nations Environment Programme (UNEP) [1,2]. It becomes impendence to look for new refrigerants to substitute for R12, R502 and R13. A parametric study and optimization of CO₂-C₃H₈ cascade system was reported by Bhattacharyya [5] for simultaneous refrigeration at -40 °C and heating at 80 °C. Another parametric study on NH₃-CO₂ cascade refrigeration system was reported recently for a temperature range of -50 to 40 °C (Getu and Bansal) [7]. Dinitrogen monoxide (N₂O) was reported to be used as a cascade refrigerant for achieving temperatures around -80 °C [3]. Carbon dioxide can be used in the low temperature stage in two stage cascade refrigeration systems [4], for which the lowest refrigeration temperature is limited above -55 °C because of its high triple-point temperature. Mixtures especially exhibiting azeotropic phase equilibrium behaviors show good potentials in cascade refrigeration systems. Studies on N₂O based systems are quite scarce in the open literature. DiNicola[6] has experimentally determined COP of carbon dioxide and nitrous oxide binary mixture in low temperature cycle with R404a in high temperature cycle and results were compared with R23 in low temperature cycle and R404a in high temperature cycle.

In this study, optimization of performance parameters of cascade refrigeration system using eco friendly refrigerants pair R507A and R23 is carried out with Genetic Algorithm tool. Eight independent variables have been varied to study their effect on performance parameters of the system with predefined range of temperature (Table. I)

II. CASCADE REFRIGERATION SYSTEM

Schematic diagram and T-s plot of two stage cascade refrigeration system are shown in fig.1 and fig.2 respectively. The refrigerant R507A is the HT cycle working fluid and refrigerant R23 is the LT cycle working fluid to provide low temperature refrigeration.

For the LT cycle, superheated R23 vapour at state 1 is

A. D. Parekh, Sardhar Vallabhbhai National Institute of Technology, Surat-395007, Gujarat, India – 395007. (e-mail: adp@med.svnit.ac.in).

P. R. Tailor, Sardhar Vallabhbhai National Institute of Technology, Surat-395007, Gujarat, India – 395007. (e-mail: prt@med.svnit.ac.in).

H.R Givanramajiwala, Sardhar Vallabhbhai National Institute of Technology, Surat-395007, Gujarat, India – 395007 (hrj1976@yahoo.co.in)

compressed to state 2 in the compressor and then cooled to saturated liquid at state 3 in the cascaded condenser.

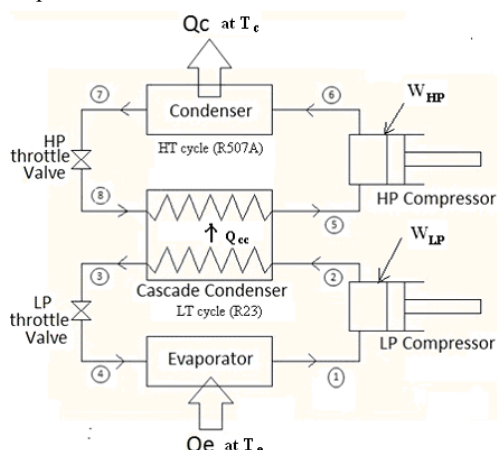

Fig. 1 Schematic diagram of cascade refrigeration system

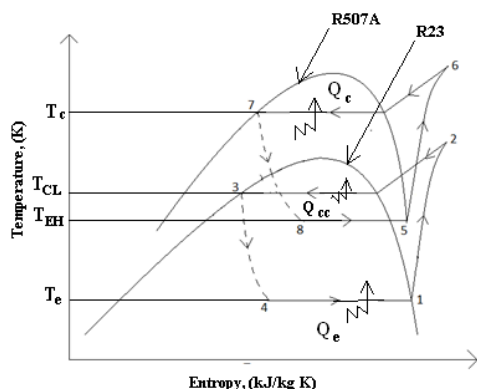

Fig. 2 T-s plot of cascade refrigeration system

The liquid at state 3 is then expanded in an isenthalpic expansion device to state 4. The useful cooling in the evaporator is achieved by evaporating refrigerant R23 from state 4 to state 1. For the HT cycle, superheated R507A vapour at state 5 is compressed to state 6; superheated vapour is then cooled in the condenser to saturated liquid at state 7. The refrigerant from state 7 is expanded to state 8 in an expansion device, followed by its heating in the cascaded heat exchanger. The only useful refrigerating effect is produced in the evaporator of low temperature side of the cascade system. The high temperature and low temperature cycle used a refrigerant with high boiling temperature and low boiling temperature respectively.

III. OPTIMIZATION METHOD

The basic principle of genetic algorithm was first proposed in the 1970s by John Holland. The genetic algorithm is based on the natural selection, which was found in biological evolution process. In the optimization design application, before a genetic algorithm can be put to work, a method is needed to encode potential solutions to the optimization problem in a form that a computer can process. One common approach is to encode solutions as binary strings: sequences of

1's and 0's, where the digit at each position represents the value of some aspect of the solution. A metric called a fitness function that allows each potential solution (individual) to be quantitatively evaluated. After a random initial population in the ranges of design variables is generated, the algorithm creates a sequence of new generations iteratively until the stopping criterion is met. In this process, the selection of parents is based on their fitness; children (next generation or population) are produced by making random changes to a single parent (mutation) or by combining the vector entries of a pair of parents (crossover), and then replace the current population children to form the next generation. The algorithm selects individuals with better fitness values as parents, and eliminates the inferior. This guarantees the algorithm converges to a best individual, which probably represents the best solution of the given problem. The flow chart of a genetic algorithm is presented in Fig. 3.

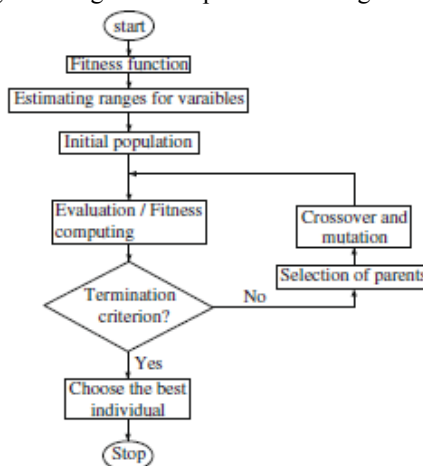

Fig. 3 Flow chart of Genetic Algorithm

A. Ranges of the Variables

As discussed in the section I, eight various temperatures of HT and LT cycles have been considered as independent variables with predefined range as shown in the table-1 which will be search space for genetic algorithm to find out best fitness value of objective function.

TABLE I TEMPERATURE RANGE OF EIGHT VARIABLES

| Eight variables (°C) | Temperature Range (°C) | |
|---|------------------------|--------|
| | Lower | Higher |
| low side evaporator temperature, A | - 80 | - 50 |
| high side condenser temperature, B | 25 | 45 |
| temperature difference in cascade heat exchanger, C | 2 | 4 |
| low side condenser temperature, D | - 40 | - 20 |
| low side degree of subcooling, E | 0 | 10 |
| high side degree of subcooling, F | 0 | 10 |
| low side degree of superheating, G | 0 | 16 |
| high side degree of superheating, H | 0 | 16 |

IV. OPTIMIZATION OF OBJECTIVE FUNCTIONS

The cascade refrigeration cycle is modeled modularly incorporating each individual process of the cycle. Governing equations have been developed to optimize objective functions using design of experiment tool. For optimization of four performance parameters program is prepared using MatLab software and Genetic Algorithm.

A. Optimization of minimum WR for the cascade system

1. Governing equation for minimum WR

$$WR = 19.685 - 1.1417(A) + 1.5949(B) + 0.3372(D) - 3844(E) + 0.2551(G) - 0.0086(A)(B) + 0.0332(A)(D) - 0.0334(A)(E) - 0.0093(A)(G) - 0.0223(B)(D) + 0.0226(B)(E) + 0.0124(B)(G) + 0.0099(D)(E) + 0.0094(A^2) - 0.0048(D^2) - 0.0044(G^2) \quad (1)$$

On applying Genetic algorithm tool following optimal value of objective function is achieved in the form of eight independent variables.

TABLE II OPTIMAL PARAMETERS' VALUE FOR WR

| A | B | C | D | E | F | G | H | WR(W) |
|-----|----|------|-----|------|------|-------|------|---------|
| -50 | 25 | 2.62 | -20 | 0.24 | 0.51 | 0.055 | 0.22 | 187.201 |
| | | | | | | | | 7 |

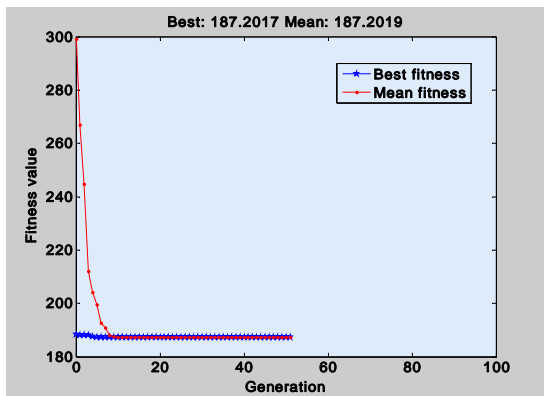

Fig. 4 Best fitness plot for WR of the cascade system

Fig. 4 shows the best fitness value plot searched by Genetic algorithm for minimum WR of the cascade system.

B. Optimization of RE₁ of the cascade system

2. Governing equation for RE₁

$$RE_1 = 481.5409 + 0.2360(A) - 5.2668(D) + 5.3608(E) + 3.8926(G) + 4.1667(10^{-5})(A)(D) - 8.3333(10^{-5})(A)(E) + 0.01839(A)(G) + 0.0199(D)(E) + 7.8125(10^{-5})(D)(G) - 0.0002(E)(G) - 0.0066(A^2) - 0.0088(D^2) - 0.0110(E^2) - 0.0082(G^2) \quad (2)$$

On applying Genetic algorithm tool following optimal value of objective function is achieved in the form of eight independent variables.

TABLE III OPTIMAL PARAMETERS' VALUE FOR RE₁

| A | B | C | D | E | F | G | H | RE ₁ (W) |
|-----|----|------|-----|----|------|----|------|---------------------|
| -50 | 39 | 3.85 | -40 | 10 | 3.81 | 16 | 4.16 | 740.09 |

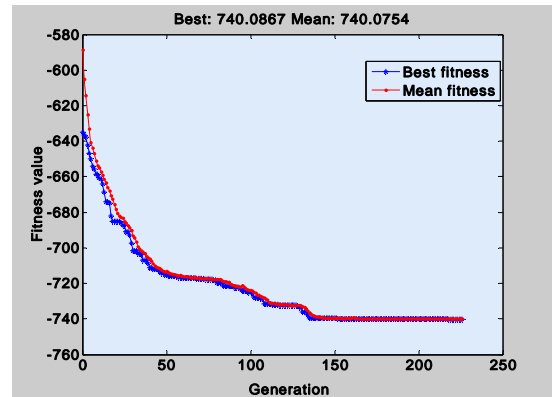

Fig. 5 Best fitness plot for RE₁ of the cascade system

Fig. 5 shows the best fitness value plot for the RE₁ of the cascade refrigeration system.

C. Optimization of COP of the cascade system

3. Governing equation for COP

$$COP = 3.9421 + 0.0339(A) - 0.0446(B) - 0.0451(C) + 0.02048(D) + 0.0153(E) + 0.0303(F) - 0.0005(G) - 0.0007(H) - 0.0004(A)(B) - 0.0004(A)(C) + 0.0002(A)(D) + 0.0003(A)(F) - 0.0001(B)(E) + 7.1025(10^{-5})(B) + 0.0001(D)(E) - 0.0001(D)(F) + 0.0006(E)(F) - 0.0004(E)(G) - 0.0004(E)(H) - 0.0004(F)(G) - 0.0004(F)(H) + 0.0002(G)(H) \quad (3)$$

On applying of Genetic algorithm, following optimal value of objective function is achieved.

TABLE IV OPTIMAL PARAMETERS' VALUE FOR COP

| A | B | C | D | E | F | G | H | COP |
|-----|----|------|-----|------|------|-------|------|-------|
| -50 | 25 | 2.02 | -20 | 9.98 | 9.99 | 0.019 | 0.12 | 1.736 |

Fig. 6 shows the best fitness value plot searched by Genetic algorithm for COP of the cascade system.

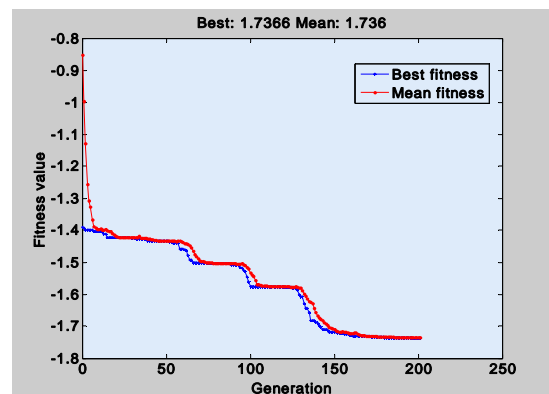

Fig. 6 Best fitness plot for COP of the cascade system

D. Optimization of η_{Exe} of the cascade system

4. Governing equation for η_{Exe} :

$$\eta_{Ex} = 0.7479 + 0.0019(A) - 0.0047(B) - 0.0084(C) + 0.0055(D) + 0.0052(E) + 0.0056(F) - 0.0002(G) - 0.0002(H) - 1.3068(10^{-5})(A)(B) + 5.8271(10^{-5})(A)(D) + 3.7521(10^{-5})(A)(F) + 3.0305(10^{-5})(B)(D) + 7.1891(10^{-5})(B)(F) + 3.0645(10^{-5})(B)(H) + 4.6563(10^{-5})(D)(E) - 5.6281(10^{-5})(D)(F) + 0.0003(E)(F) - 0.0002(E)(G) - 0.0002(E)(H) - 0.0002(F)(G) - 0.0002(F)(H) + 0.0001(G)(H) \quad (4)$$

On applying of Genetic algorithm optimization tool following optimal value of objective function is achieved.

TABLE V OPTIMAL PARAMETERS' VALUE FOR η_{Exe}

| A | B | C | D | E | F | G | H | η_{Exe} |
|-----|----|---|-----|----|----|-------|---|--------------|
| -50 | 25 | 2 | -20 | 10 | 10 | 0.003 | 0 | 0.6017 |

Fig.7 shows the best fitness value plot searched by Genetic algorithm for Exergetic efficiency of the cascade system.

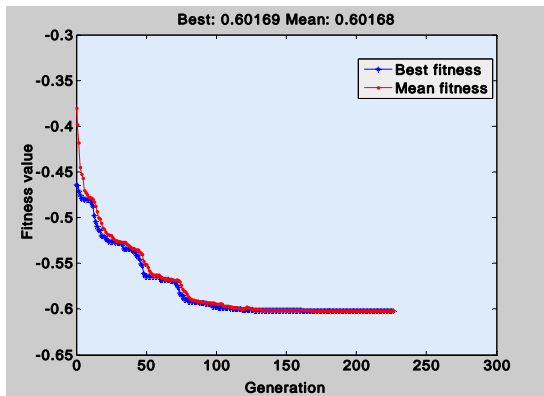

Fig.7 Best fitness plot for η_{Exe} of the cascade system

V. RESULTS AND DISCUSSION

There are eight independent variables that affect performance of cascade refrigeration system, so it is not possible to predict or calculate accurately, the optimal value of these parameters and their combinations manually. So there is a need of some technique or tool to be used to find out optimal value of all affecting parameters to the system performance and to find out the importance level of each affecting parameters.

By using optimization tool one can design more efficient system considering optimal value combinations of parameters which will results in higher performance of the system. For the predefined range of eight parameters, Table.II show the results obtained by the Genetic Algorithm optimization tool for minimum work required for the system. The result shows that optimal value of minimum work required (WR) for the system is 187.20 W and for this value, combinations of eight variables searched by GA tool. According to these combinations, value of WR is minimum, if system operate with TEL = -50 °C, TCH = 25 °C, DT = 2.6 °C, TCL = -20 °C and without subcooling and superheating in both side. For

validation, result was compared with results of R404A-R508B cascade refrigeration cycle optimized by A.D Parekh [8]. As this refrigerant pair has almost similar physical properties as with R507A-R23 pair. Minimum work required with R404A-R508B is 195 W and combinations of eight variables are having value TEL = -50 °C, TCH = 25 °C, DT = 2 °C, TCL = -20 °C, DSCL=0, DSCH= 0 °C, DSHL = 0, DSHH = 0 °C. This result validates GA result for minimum work required in our case.

For refrigeration effect (RE1) optimal value achieved is 740.08 W and for this value, combinations of eight variables are searched by GA tool. According to these combinations, value of RE1 is maximum if system operate with TEL = -50 °C, TCH = 39.04 °C, DT = 3.85 °C, TCL = -39.99 °C and degree of subcooling 10 °C in low side and degree of superheating 16 °C in low side, while in HT circuit value of both subcooling and superheating are near 4 °C. Fig.5 shows best fitness value for objective function is 740.08 W. On comparison of these results with results achieved in [8], maximum value of RE1 is 720 W with combinations having value TEL = -50 °C, TCH = 45 °C, DT = 4 °C, TCL = -40 °C, DSCL= 10, and DSHL =16 while DSCH= 6 and DSHH = 4°C. GA results are close to this combination.

For COP optimal value is 1.736 and for this value, combinations of eight variables searched by GA tool. According to these combinations, value of COP is maximum if system operate with TEL = -50 °C, TCH = 25 °C, DT = 2 °C, TCL = -20 °C, degree of subcooling 10 °C in low side and high side and degree of superheating should be zero on both side. Fig.6 shows best fitness value for objective function is 1.736. Comparison with results achieved in [8] shows that maximum value of COP is 1.685 with combinations having value TEL = -50 °C, TCH = 25 °C, DT = 2 °C, TCL = -40 °C, DSCL= 10 °C, and DSCH = 10 °C degree of superheating 0 °C in both circuits.

These results achieved by GA, for the maximum COP is very interesting and indicative as it guides towards ideal cycle parameters with maximum performance.

For exergetic efficiency, optimal value is 0.6017 and for this value, combinations of eight variables searched by GA tool. According to these combinations, value of exergetic efficiency is maximum if system operate with TEL = -50 °C, TCH = 25 °C, DT = 2 °C, TCL = -20 °C, degree of subcooling 10 °C in low side and high side and degree of superheating should be 0 °C on both side. These results are similar to maximum COP results.

Fig.7 shows best fitness value for objective function is 0.6017. On comparison of this results with results achieved in [8], maximum value of exergetic efficiency is 0.6010 with combinations having value TEL = -50 °C, TCH = 25 °C, DT = 2 °C, TCL = -20 °C, DSCL= 10 °C, and DSCH = 10 °C while degree of superheating 0 °C in both circuit.

Hence results of optimum parameters obtained with GA validates with the results of A.D.Parekh [8].

VI. CONCLUSION

Optimization of R507A-R23 cascade refrigeration system performance parameters has been carried out using GA is presented in this study. From this study the following conclusions are drawn.

- For minimum WR, one should operate cascade system with high TEL, low TCH, high TCL, low DT, with lower degree of subcooling and superheating in both sides.
- For maximum system refrigeration effect RE₁, system should operate with high TEL, low TCH, low TCL, low DT, with higher degree of subcooling and superheating in low side and lower degree of subcooling and superheating in high side.
- For maximum system COP, system should operate with high TEL, low TCH, high TCL, low DT, higher degree of subcooling in low and high side and lower degree of superheating in low and high side.
- Also analysis reveals that for maximum exergetic efficiency, system should operate with high TEL, low TCH, high TCL, low DT, higher degree of subcooling in low and high side and lower degree of superheating in low and high side.

NOMENCLATURE

| | |
|---------------------|---|
| A, T _{EL} | low side evaporator temperature (°C) |
| B, T _{CH} | high side condenser temperature (°C) |
| C, DT | temperature difference in cascade heat exchanger(°C) |
| D, T _{CL} | low side condenser temperature (°C) |
| E, DSC _L | low side degree of subcooling (°C) |
| F, DSC _H | high side degree of subcooling (°C) |
| G, DSH _L | low side degree of superheating (°C) |
| H, DSH _H | high side degree of superheating (°C) |
| Q | total heat transfer (W) |
| WR | minimum work required (W) |
| RE ₁ | refrigeration effect (W) |
| COP | coefficient of performance |
| | Greek Symbols |
| η _{Exe} | Second law efficiency (exergetic efficiency) |
| | Subscripts |
| e | evaporator |
| c | condenser |
| cc | cascade condenser |
| L | low temperature side of the cascade refrigeration system |
| H | high temperature side of the cascade refrigeration system |
| | Abbreviation |
| HFC | hydro fluorocarbon |
| GA | Genetic algorithm |
| ODP | Ozone depletion potential |

REFERENCES

- [1] Montreal Protocol on substances that deplete the ozone layer. United Nations Environment programme (UNEP), 1987.
- [2] UNEP Assessment report of the technology and economic assessment panel, UNEP Ozone Secretariat, Nairobi, Kenya-2007.
- [3] Kruse, H., Ru. ssmann. H. The natural fluid nitrous oxide-an option as substitute for low temperature synthetic refrigerants, International Journal of Refrigeration, 29 (5), 2006, pp. 799-806.
- [4] Nicola G.D, Giuliani G., Polonara F., Stryjek.R. Blends of carbon dioxide and HFCs as working fluids for the low temperature circuit in cascade refrigeration systems. International Journal of Refrigeration, 28, 2005, pp. 130-140.

- [5] Bhattacharyya, S., Mukhopadhyay, S., Kumar, A., Khurana, R.K., Sarkar, J., 2005. Optimization of a CO₂-C₃H₈ cascade system for refrigeration and heating. Int. J. Refrigeration 28 (8),1284–1292.
- [6] DiNicola, G., Giuliani, G., Polonara, F., Santori, G., Stryjek, R., 2007. Cascade Cycles Operating with CO₂ -N₂O Binary Systems as Low Temperature Fluid: Experimental Results. International Congress of Refrigeration, Beijing.
- [7] Getu, H.M., Bansal, P.K., 2008. Thermodynamic analysis of an R744–R717 cascade refrigeration system. Int. J. Refrigeration 31 (1), 45–54.
- [8] A.D.Parekh, V.H.Oza, P.R.Tailor, Thermodynamic analysis and optimization of R404A-R508B cascade refrigeration system, 2nd International Conference on Advances in Mechanical Engineering, August-2009, pp. 1-5.