

CAD Tools Broadband Amplifier Design

Salwa M. Salah Eldeen, Fathi A. Farag, and Abd Allah M. Moselhy,

Abstract—This paper proposed a new CAD tools for microwave amplifier design. The proposed tool is based on survey about the broadband amplifier design methods, such as the Feedback amplifiers, balanced amplifiers and Compensated Matching Network. The proposed tool is developed for broadband amplifier using a compensated matching network "unconditional stability amplifier". The developed program is based on analytical procedures with ability of smith chart explanation. The C# software is used for the proposed tools implementation. The program is applied on broadband amplifier as an example for testing. The designed amplifier is considered as a broadband amplifier at the range 300-700 MHz. The results are highly agreement with the expected results. Finally, these methods can be extended for wide band amplifier design.

Keywords— *Broadband amplifier* (BBA) – Compensated Matching Network - Microwave Amplifier

I. INTRODUCTION

Many modulation and coding circuits require amplifiers with a wideband of operation. From the RF point of view, one of the major problems in broadband amplifiers design is the limitation imposed by the gain bandwidth product of the active device. Any active device has a gain roll off at higher frequencies due to the parasitic capacitances. Eventually, as the frequency reaches the transition frequency f_T . The transistor stops functioning as an amplifier and turns attenuative [1].

The forward gain $|S_{21}|$ as shown in Fig.1 seldom remains constant over the frequency band of operation necessitating compensation measures. Beside gain degradation, other complications that arise in the design of broadband amplifiers include:

- Increase in the reverse gain $|S_{12}|$, which degrades the overall gain even further and increases. The possibility for a device to fall into oscillation.
- Frequency variations of $|S_{11}|$ and $|S_{22}|$.
- Noise figure degradation at high frequencies.

Salwa M. Salah, Benha Electronics CO., Egypt (phone: 002-0110320474; e-mail: eng_solly2005@yahoo.com).

Fathi A. Farag, is with the electronic and communication department, Zagazig university, Egypt(e-mail: ffarag@zu.edu.eg).

Abd A. Moselhy, Chair of Electrical Engineering, Higher technological Institute and Computer, Tenth of Ramadan City.

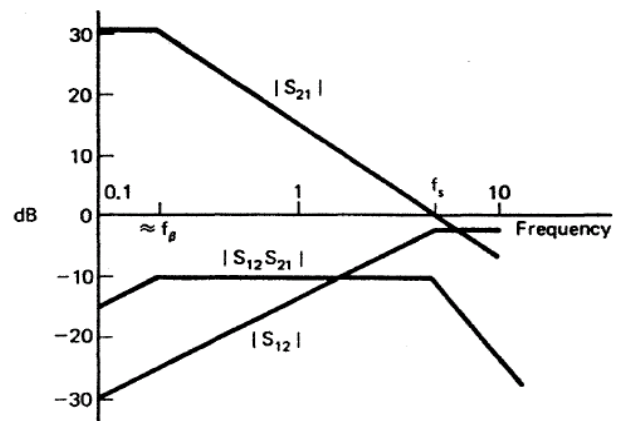

Fig.1, Bode plot of $|S_{21}|$, $|S_{12}|$, and the product $|S_{12}S_{21}|$ [2].

The design of RF amplifier requires essentially device models/S-parameters, CAD tools, matching and biasing networks, and fabrication technology [3]. Each type mandates additional insights to meet required amplifier specifications. For example, a low-noise amplifier (LNA) [4] needs a low-noise device and a low-loss input matching network. Also, the review of power amplifier (PA) [4-6] requires a power device and low-loss output matching network [7].

The paper is organized as follows. Section II presents the broadband amplifier design methodologies. The designed steps discussed in Section III. Section IV introduces the proposed CAD tools. The application example is depicted in section V.

II. BROADBAND AMPLIFIER DESIGN

The design of broadband microwave amplifiers [8] is a problem of the power gain roll off between the device and frequency. The design philosophy in a broadband amplifier is to obtain a flat gain over a prescribed range of frequencies [9]. This can be obtained by the use of several methods in order to compensate the variations of S-parameters with different frequencies. This can be done by:

- A. Feedback amplifiers
- B. Balanced amplifier
- C. Compensated matching network

A. Feedback Amplifiers

Feedback amplifiers have been adopted for use as

microwave broadband amplifiers. Feedback amplifiers have two principal advantages:

- 1) Broadband gain characteristics can be obtained by suppressing gain variations passband.
- 2) The low noise figure is achieved under conditions of broadband low VSWR.

Moreover, the feedback amplifier controls the amplifier performance due to variations in the S parameters from transistor to transistor.

As the bandwidth requirements of the amplifier approach a decade of frequency, gain compensation based on matching networks only is very difficult, and negative feedback techniques are used. In fact, a microwave transistor amplifier using negative feedback [2, 10] can be designed to have very wide bandwidth (Greater than 2 decades) with small gain variations (tenth of a decibel). And also negative feedback will degrade the noise figure and reduce the maximum power gain available from a transistor. A two-stage cascaded LNA [11] employing local reactive feedback networks and a current-reuse scheme is introduced as a low-power, low-noise, and moderate-gain solution. Feedback amplifiers, when properly designed, provide good stability against process, temperature and supply voltage variations. They offer the possibility to exchange gain versus bandwidth and set port impedances freely. Several types of feedback amplifiers are commonly used:

Resistive feedback amplifiers as shown in Fig.2 can provide good port match and tend to be rather stable. However, their noise performance is degraded by the added noise of feedback resistors. The degradation is particularly significant if strong a large bandwidth is applied [12].

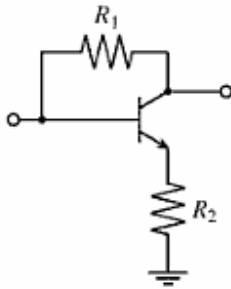

Fig.2, Negative resistive feedback circuits [1]

Reactive feedback topologies [13] that are very attractive in hybrid designs do not have this drawback; large bandwidths can be obtained without compromising dynamic range. the required multi-winding transformers can be realized monolithically, but suffer from their low Q's and a limited inductance range.

Active feedback amplifiers are well suited for monolithic integration and do not exhibit impaired noise properties. They are promising candidates for moderate bandwidths. If a large bandwidth and therefore a strong feedback are required, the excessive phase shift usually causes stability problems.

B. Balanced amplifier design

The use of balanced amplifiers [14] to have broadband amplifier with flat gain and VSWR =1. The most popular arrangement of a balanced amplifier uses two couplers as shown in Fig.3. The input coupler divides the input power equally between ports, and the output coupler recombines the output signals from the amplifiers. Therefore the coupler shows in Fig.3 must be achieved wave relations as Eq.1.

$$\left. \begin{aligned} |S_{11}| &= 0.5|S_{11a} - S_{11b}| \\ |S_{21}| &= 0.5|S_{21a} + S_{21b}| \\ |S_{12}| &= 0.5|S_{12a} + S_{12b}| \\ |S_{22}| &= 0.5|S_{22a} - S_{22b}| \end{aligned} \right\} \quad (1)$$

If the two amplifiers are identically then, $|S_{11}| = 0$ & $|S_{22}| = 0$ and the input and output VSWR =1. The bandwidth of amplifier is limited by the bandwidth of the coupler [15]. The bandwidth of couplers is controlled by parasitic elements. There are many advantages to the balanced amplifier configuration. The amplifiers can be designed for low noise figure, flat gain, with little impact on the overall performance of the circuit. The input and output VSWR depends mainly on the coupler than the individual match of the transistors. If one of the devices fails, amplification is still achievable with reduced gain. This configuration tends to have a high degree of stability. Lastly, cascading these types of amplifiers is easily done since the couplers isolate each section of the cascade. The type of coupler used depends on the available space for the circuit as well as the specific design goals of the amplifier. Couplers used as combiners or dividers, are often of the hybrid type. There are two common types of couplers can be used hybrid couplers and Lange couplers That is, when properly terminated, they maintain isolation between the two signals to be combined or generated by the division. But Lange coupler that is shown in Fig.4, have a few benefits over a hybrid coupler and have been used in MMIC "Monolithic Microwave Integrated Circuits" balanced amplifier designs. Lange couplers are smaller than hybrid couplers [15]. Generally, the physical length of the Lange coupler is approximately equal to a quarter wavelengths at the center frequency on the host substrate. The combined width of the strips is comparable to width of a 50Ω line on the host substrate. In contrast, the hybrid coupler is a quarter wavelengths at center frequency on the host substrate in both width and height. The Lange coupler also has better performance when compared to a hybrid coupler. When a Lange coupler is being used, it is important to make sure the widths of the fingers of the Lange are realizable. Also, the Lange coupler is a 3-dimensional circuit which can add complexity to the fabrication of the circuit. The major design constraint in the design of this balanced amplifier was the space limitation.

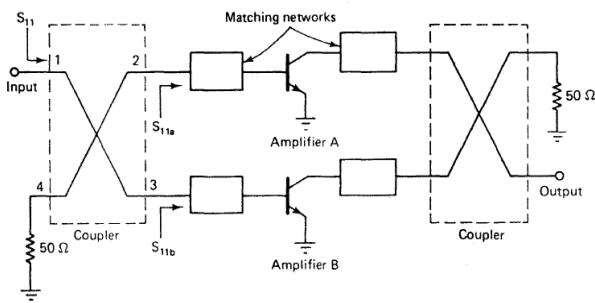

Fig.3, balanced amplifier configuration [2]

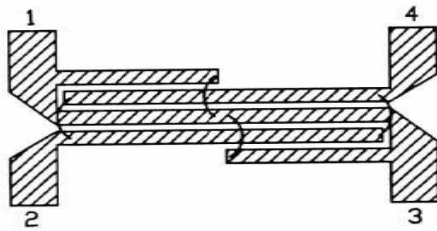

Fig.4, Lange coupler Layout of the micro strip pattern [13]

C. Compensated matching network

Fig.5 shows general block diagram for any microwave amplifier which consists of a transistor as amplifier block, the input matching and then the output matching circuit. The matching circuits provide optimum performance in microwave amplifier. The Compensated matching network is used to compensate the changes of S-parameters of active devices with frequency. The matching networks as shown in Fig.5 are designed to give the best input and output VSWR and flat gain over the band of frequencies. The design of compensated matching networks can be done in analytical form with the help of smith chart. There are several steps are done to achieve the required goal. The first step is choosing the broadband amplifier transistor with acceptable noise and sufficient gain. The second step is to check unilateral figure of merit and stability of the transistor to ensure that the transistor is unilateral and unconditionally stable at the operating frequency. The third step is the design of matching circuits in order to match the transistor with the input source and output load. These matching circuits can be designed to achieve a flat gain over the frequency band. The fourth step is to draw the constant gain circles for each frequency. The last step is the design of matching circuit. At complex analytical procedures, the use of CAD (Computer Aided Design) methods is required with use analytical procedure at starting design. The matching network can be designed using network synthesis techniques which uses lumped implement filter with microwave components

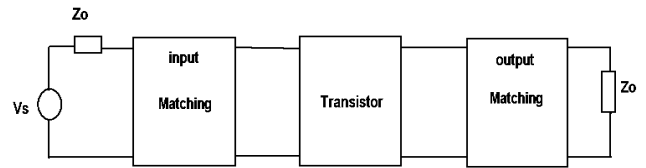

Fig. 5, The general block of the broadband amplifier

III. DESIGN PROCEDURES

1) Unilateral figure of merit

All two-port models are bilateral, so both the forward and reverse signal flow must be considered. If the signal flow in the reverse direction is much smaller than the flow in the forward direction, it is possible to make the simplification that the reverse flow is zero. The unilateral figure of merit is a quick calculation that can be used to determine where this simplification can be made without significantly affecting the accuracy of the model [16].

The transistor is considered as unilateral amplifier, if the following condition is satisfied

$$-0.5dB < \frac{G_T}{G_{TU}} < 0.5dB \tag{2}$$

$$\frac{1}{(1+U)^2} < \frac{G_T}{G_{TU}} < \frac{1}{(1-U)^2} \tag{3}$$

$$where \ U = \frac{|S_{11}||S_{12}||S_{21}||S_{22}|}{(1-|S_{11}|^2)(1-|S_{22}|^2)} \tag{4}$$

Where, U is the unilateral figure of merit, GT is the transducer power gain, and GTU is the unilateral transducer power gain.

2) Stability considerations

Stability of amplifier is its resistance to oscillate. The transistor should be unconditionally stable at the range of frequencies. The necessary and sufficient conditions for unconditionally stability are $K > 1$ & $|\Delta| < 1$

$$K = \frac{1-|S_{11}|^2 - |S_{22}|^2 + |\Delta|^2}{2|S_{12}S_{21}|} \tag{5}$$

Where, K is the Rollet stability factor.

$$|\Delta| = |S_{11}S_{22} - S_{12}S_{21}| \tag{6}$$

3) The operating gain (Go)

The operating gain is the gain of the transistor which varies with frequency as it depends on $|S_{21}|$ as shown in Fig.1.

4) Output / input matching circuit

The output matching is designed by plotting the constant -gain circles

$$g_L = \frac{G_L}{G_{L \max}} \tag{7}$$

g_L is the normalized gain factor

$$G_{LdB} = G_o - G_p \quad (8)$$

$$G_{L \max} = \frac{1}{1 - |S_{22}|^2} \quad (9)$$

Schematically, Fig. 6 shows the constant gain circles on smith chart. The center and radius of constant gain can be calculated from equations (13, 14).

The center of load constant gain circle

$$C_L = \frac{g_L S_{22}^*}{1 - |S_{22}|^2 (1 - g_L)} \quad (10)$$

The radius of the constant gain circle

$$R_L = \frac{\sqrt{1 - g_L} (1 - |S_{22}|^2)}{1 - |S_{22}|^2 (1 - g_L)} \quad (11)$$

By using lumped elements matching in the ZY smith chart which specifies series and shunt inductors "L" as in narrowband amplifier shown in Fig.7. The shunt inductance transforms the 50Ω load along a circle of constant conductance and varying inductive susceptance. And the series inductor transforms the combination of the 50Ω load and the shunt inductance along circles of constant resistance and varying inductive reactance. These matching impedance s achieve the best output VSWR.

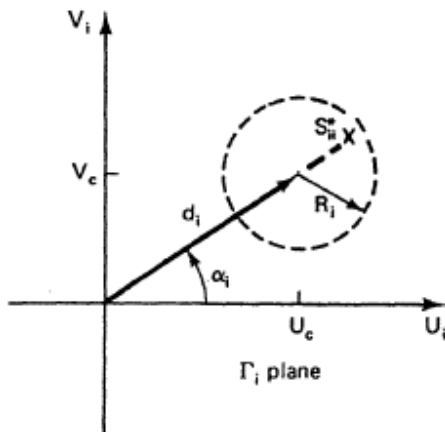

Fig.6, Constant gain circle on smith chart

For no repeat the previous analysis for the input matching network; the same as in the output matching analysis is considered with replacing the load notation "L" by the source notation "S". Also the replacements between S11 with S22 are considered.

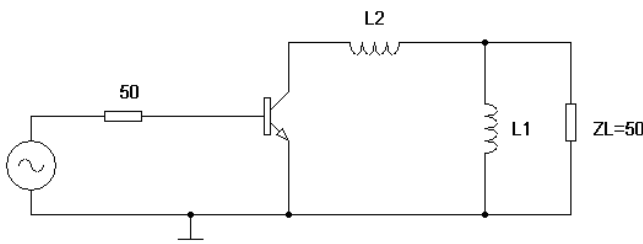

Fig.7, schematics diagram of a broadband amplifier

IV. PROPOSED CAD PROGRAM

This paper produces a new proposed program for compensated matching network design technique. A proposed algorithm is shown in Fig.8. The design steps can be abstracted as follows:

- firstly, check unilateral of the amplifier process as shown in Eq. (2)
- The stability of the amplifier is checked if it is unconditional stable by using the conditions are shown in equ. (5, 6).
- Drawing the constant gain circles on the smith chart as shown in fig.6, According to the required gain which their centers and radiuses are calculated by equ. (10, 11).
- Finally, specifying the matching elements by using lumped elements on ZY smith chart as in Narrowband amplifier.

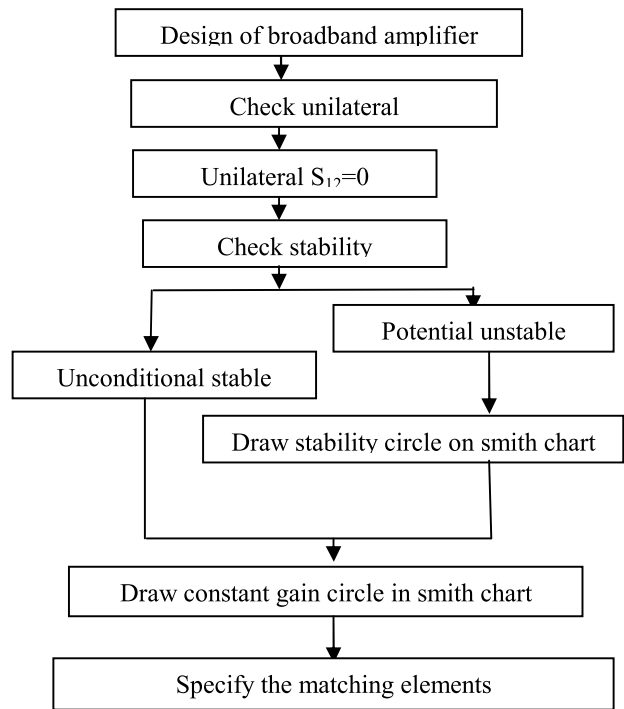

Fig.8, Block diagram of proposed approach

This algorithm is implemented in C# program as an easy and efficiency. The proposed program just runs on widows have a .NET Framework package. The interface of proposed program is shown in Fig.9.

V. ILLUSTRATIVE EXAMPLE

Design a broadband amplifier with the following specifications in table.1 with greatest degree of flatness at 10dB gain from 300-700 MHz. the 2N3478 transistor will be implied. The S-parameters of the 2N3478 are shown in Table.1.

TABLE I

S-PARAMETERS OF TRANSISTOR AT EACH FREQUENCY [2]

F"MHz"	S ₁₁	S ₂₁	S ₂₂
300	0.3∠-45	4.47∠40	0.86∠-5
450	0.27∠-70	3.16∠35	0.855∠-14
700	0.2∠-95	2∠30	0.85∠-22

Firstly, the required specifications such as transducer power gain "GT" and the number of frequencies are written as shown in Fig. 9. Then the S- parameters at each frequency can be entered as an angle and magnitude.

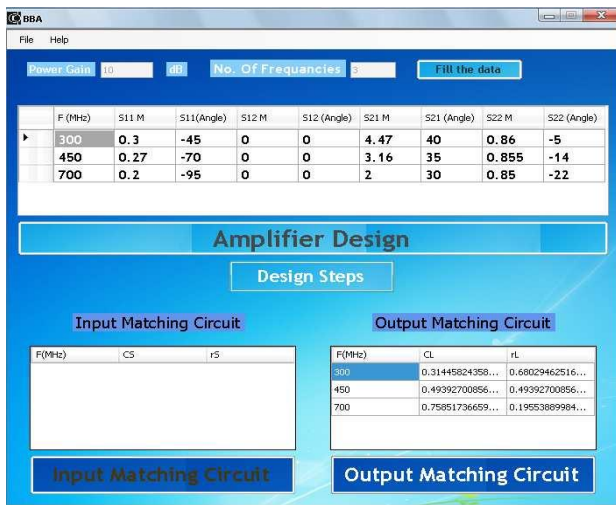

Fig.9 The interface of proposed program

Then; the radiuses and centers of the constant gain circles can be calculated from the proposed program as in Fig.10 at the given S-parameters.

For comparison, the output constant gain circles radius and center in [2], is shown in table.2

TABLE II
 CONSTANT GAIN CIRCLES CALCULATIONS

F"MHz"	C _L	r _L
300	0.31	0.68
450	0.49	0.49
700	0.76	0.2

F(MHz)	CL	rL
300	0.31445824358...	0.68029462516...
450	0.49392700856...	0.49392700856...
700	0.75851736659...	0.19553889984...

Fig.10 The output constant gain circles radius and center.

More details about the output matching circuit can be obtained from the proposed program as shown in Fig.11. This figure shows the matching network on smith chart. The Design on the ZY smith chart performs the required transformation of the 50-Ω load. This figure shows the constant gain circles. These circles are corresponding to the S-parameters. The matching network selected is consisting of a shunt and series inductor combination. Optimizing the values of shunt and series L is a cut-and-try process to adjust these elements so that the transformed load reflection terminates on the right gain circle at each frequency, and the susceptance component decrease with frequency [17]. Once appropriate constant-conductance and constant circles have been found, the reactances and susceptances of the elements can be read directly from the smith chart. Then the element values are calculated, the same as they were for the narrowband design. According to this rule the program gives the value of the reactance "JX" and susceptances "Jb" directly.

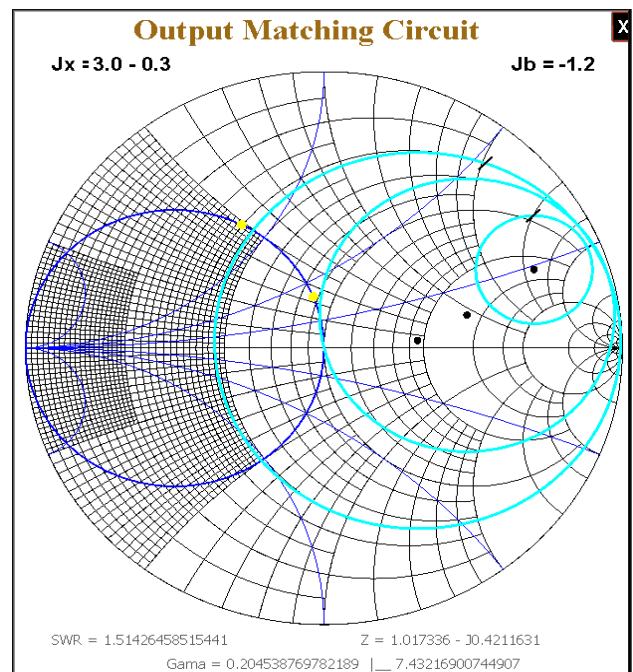

Fig.11, Output matching circuit with lumped elements

Similarly, the input matching circuits can be designed by the proposed CAD program. According to this considered example, there is no input matching circuit because the average of maximum input gain is less than one so the input is directly connected of the 50-Ω source resistor to the base of the transistor.

Comparison between the matching elements result from the proposed CAD program and the result into [2] is shown in table.3. Where the circuit element values "L₁, L₂" of Fig.7 can be defined.

TABLE III
COMPARISON BETWEEN [2] AND THE PROPOSED PROGRAM

Ref.[2]	CAD results
$J_{b1} = -j1.2$ Or $L_1 = 22.1 \text{ nH}$	$J_b = -j1.2$ Or $L_1 = 22.1 \text{ nH}$
$J_{s2} = j(3.2 - 0.4)$ Or $L_2 = 31.8 \text{ nH}$	$J_x = j(3.0 - 0.3)$ Or $L_2 = 30.07 \text{ nH}$

VI. CONCLUSION

In this paper, the design methodologies of the broadband amplifier have been reviewed. Moreover, the input and output matching networks are considered. A CAD tool has been proposed for broadband amplifier design. The proposed tool has been developed for broadband amplifier using a compensated matching network "unconditional stability amplifier". The C# software has been employed for the proposed tools implementation. An amplifier has been designed as a broadband amplifier at the range 300-700 MHz. The results are highly agreement with the expected results. Moreover, these methods can be extended for wide band amplifier design. Also some optimization process can be added for the best selected frequencies designing matching points.

REFERENCES

- [1] R. Ludwig; G. Bogdanov, "RF Circuit Design: Theory and Application", Prentice Hall, 2008.
- [2] G. Gonzalez, "Microwave Transistor Amplifiers Analysis and Design," (2nd Ed.) Prentice-Hall, Inc., Upper Saddle River, NJ, 1996.
- [3] W. S. A. Ibrahim "Analysis and Design of Microwave Transistor Amplifier "Master Thesis, engineering faculty, Zagazig University, 2004.
- [4] I. J. Bahl , " Fundamentals of RF and Microwave Transistor Amplifiers", John Wiley & Sons, Inc ,June 2009.
- [5] C. fuetes, "Microwave Power Amplifier Fundamentals ",A Giga Tronics Technical white power .pp.1-24,October 2008.
- [6] B.L. Nelson et. al. "High-linearity, low DC power GaAs HBT broadband amplifiers to 11 GHz", GaAs IC Symposium, pp. 79-82, Oct. 1989 .
- [7] Y. Inoue, M. Sato, T. Ohki, K. Makiyama, T. Takahashi, H. Shigematsu, and T. Hirose," A 90-GHz InP-HEMT Lossy Match Amplifier With a20-dB Gain Using a Broadband Matching Technique", IEEE journal of solid-state circuits, vol. 40, no. 10, pp 2098- 2103, October 2005.

- [8] H.A.ELMotaafy,H.M.ELHefnawy,EL.S.A.ELBadawy and S.H.Ibrahim, " Design and Analysis of a 2-4GHz Broadband High Gain Microstrip Amplifier",the fourth Saudi engineering conference ,VOLIII,PP.195-200. Nov.1995.
- [9] L. Samuel, "Microwave Devices and Circuits ",Prentice-Hall,Inc., England cliffs, N.J., 1987.
- [10] Perez, F. Ortega, V," Broadband Design of Microwave Power MESFET Amplifiers using Negative Feedback Techniques", European Microwave Conference, pp 596-600,2007.
- [11] M. Liu, J. Crainckx, N. M. Iyer, M. Kuijk, and A.R. F. Barel," A 6.5-kV ESD-Protected 3–5-GHz Ultra-Wideband BiCMOS Low-Noise Amplifier Using Interstage Gain Roll-Off Compensation", IEEE transactions on microwave theory and techniques, VOL. 54, no. 4,pp 1698- 1706, April 2006.
- [12] U. Lott and W. Baumerger, "Broadband 0.7GHz MESFET Amplifier with Low Noise Figure up to fT/2 of The Active Device", GAAS 1994 turin, italy , pp.393-395, april 1994.
- [13] M. T. Reiha and J. R. Long, "a 1.2 v reactive-feedback 3.1–10.6 ghz low-noise amplifier in 0.13 μm cmos",IEEE journal of solid-state circuits, vol. 42, no. 5, pp. 1023-1033, may 2007.
- [14] Y. Liu, T. Yang, Z. Yang, and J. Chen," A 3–50 GHz Ultra-Wideband PHEMT MMIC Balanced Frequency Doubler", IEEE microwave and wireless components letters, vol. 18, no. 9, pp 629- 631, September 2008.
- [15] F. Sechi and M. Bujatti, "Solid-State Microwave High-Power Amplifiers", Artech House Inc., Norwood MA,2009.
- [16] T.T. Ha, "Solid State Microwave Amplifier Design", Wiley-Interscience, New York, 1981.
- [17] R. W. Anderson, "S Parameter Techniques for Faster, More Accurate Network Design," Hewlett-Packard Application Note 95-1, February 1967