

# Application of “streamlined” material accounting to estimate environmental impact

Paul Osmond

**Abstract**— This paper reports a new application of material accounting techniques to characterise and quantify material stocks and flows at the “neighbourhood” scale. The study area is the main campus of the University of New South Wales in Sydney, Australia. The system boundary is defined by the urban structural unit (USU), a typological construct devised to facilitate assessment of the metabolism of urban systems. A streamlined material flow analysis (MFA) was applied to quantify the stocks and flows of key construction materials within the campus USU over time, drawing on empirical data from a major campus development project. The results are reviewed to assess the efficacy of the method in supporting urban environmental evaluation and design practice, for example to facilitate estimation of significant impacts such as greenhouse gas emissions. It is concluded that linking a *service* (in this case, teaching students) enabled by a given *product* (university buildings) to the amount of materials used in creating that product offers a potential way to reduce the environmental impact of that service, through more efficient use of materials.

**Keywords**— Construction materials, Material flow analysis, Urban metabolism, Urban structural unit.

## I. INTRODUCTION

THE research reported here extends a streamlined material flow analysis case study focusing on construction materials [1] to examine the relationship between the material intensity of the buildings in question and the services which they provide.

Material flow analysis is “the systematic assessment of the flows and stocks of materials within a system defined in space and time” [2: 3] to help quantify the environmental impacts of human activities. It developed out of mass balance (input-output) methods traditionally used in chemical and process engineering.

MFA connects sources, pathways and sinks of *materials*, which may be either *substances* (chemical elements or discrete compounds) or *goods* (substances or mixtures of substances of positive or negative economic value). *Processes* are defined as the transport, transformation or storage of materials, linked by material *flows*, in units of mass per time interval, or *fluxes*, in units of mass per time and cross-section (e.g. per hectare, per capita etc). Materials stored within the system, which may increase or decrease over time, are described as *stocks*. A *system* comprises the material flows, processes and stocks within identified spatial and temporal boundaries.

P. Osmond is with the Sustainable Development Program in the Faculty of the Built Environment, University of New South Wales, Sydney 2052 Australia (email: p.osmond@unsw.edu.au).

MFA is predicated on the conservation of matter when subjected to physical or chemical transformative processes:

$$\sum_{k_I} m_I = \sum_{k_O} m_O + m_S \quad (1)$$

where  $m$  represents mass,  $k$  represents the number of flows,  $I$  refers to input,  $O$  to output, and  $S$  to storage (accumulation or depletion of materials).

The proportion of the total throughput of a substance  $X$  which is transferred into a specific output good via a given process is given by its transfer coefficient  $TC$ :

$$TC_i = \dot{X}_{O,i} / \sum_{i=1}^{k_I} \dot{X}_{I,i} \quad (2)$$

$$\text{and} \quad \sum_{i=1}^{k_O} TC_i = 1 \quad (3)$$

where  $k_I$  = number of input flows and  $k_O$  = number of output flows [2].

Kleijn and van der Voet [3] differentiate between bulk MFA, which accounts for all material flows for the system in question, and substance flow analysis (SFA), which focuses on the environmental loadings generated by one or a limited number of indicator substances (e.g. through comparison of anthropogenic vs. geogenic concentrations), often environmentally toxic materials such as cadmium or lead. Although Blair *et al.* [4] argue that MFA is very resource intensive and better suited to measurement of single or simple materials, increasing availability of input and output data at scales ranging from national economies [5] to individual industrial processes [2] allows increasingly detailed evaluation of anthropogenic systems. It represents a useful tool to support resource and waste management, environmentally conscious design of products and services and industrial ecology. The major limitation of MFA and other material accounting methods is intrinsic; by definition, they deal only with the *material* aspects of human-environment interactions [6].

A bulk MFA typically requires collection of an extensive materials inventory. On the other hand, a “streamlined” MFA, restricted to quantification of the stocks and flows of selected, representative *goods*, as discussed here, can supply sufficient data to enable an initial estimate of environmental impact.

Applying MFA to built form, stocks equate to the total mass of construction materials, which may be disaggregated by material type – concrete, steel, glass etc. This may be quantified in relation to building volume, gross floor area, number of occupants, activities etc for a given time period.

Inputs include raw materials and prefabricated or manufactured components, and outputs include wastes and pollutants, some of which may be recycled (fig. 1).

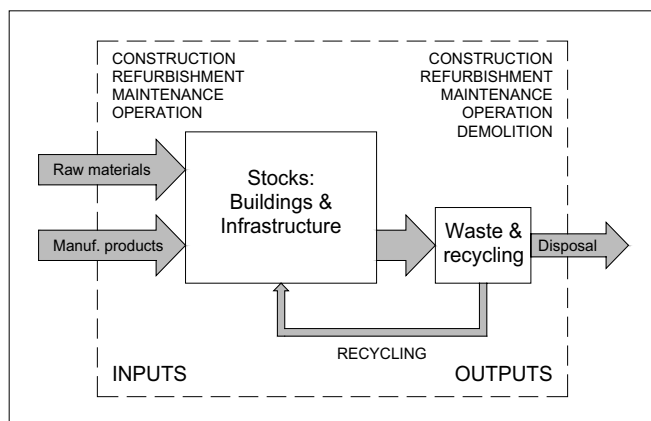

Fig. 1 Simplified model for the material flows and stocks relating to built form. The system boundary (dashed line) is the urban structural unit. Internal process-related stocks and flows (e.g. use of machinery in construction and demolition) are ignored as they are considered minor in comparison with building materials. Another major input is of course energy, with the output being dissipated heat.

The life cycle processes of construction, operation and maintenance, refurbishment and demolition each generate particular material flows, reflecting the differing life spans of building elements, the activities of the occupants and external economic, social and cultural drivers [7]. Linking these flows to the *services* they provide enables calculation of the material input per unit service (MIPS). MIPS is based on the proposition that material flows represent a proxy for the diverse environmental impacts of human activities, and are best measured as *inputs*, given that a) all inputs to the economy ultimately end up as emissions or wastes; b) data handling is reduced; and c) opportunities for economic or regulatory intervention are increased [8-9].

A full MIPS analysis involves the calculation of all material inputs – including the so-called “ecological rucksack” of materials used in the product life cycle but not physically included in the product [9] – across five areas: abiotic raw materials; biotic raw materials; moved soil in agriculture and forestry; air; and water. The *service unit* part of the equation acknowledges that consideration of the service provided (e.g. “mobility”) provides the basis for comparative evaluation of the product (e.g. “car” vs. “train”), to minimise environmental impact, i.e. a measure of *material efficiency*.

Thuvander distinguishes two types of change in built form: changes to buildings during their lifetime; and changes in the composition of the overall building stock resulting from construction and demolition [7]. The present research focuses on building construction and demolition, and ignores material flows relating to refurbishment, maintenance and operation of the buildings due to lack of meaningful time series data. The spatial system boundary is defined by the *urban structural unit*

(USU), a typological construct devised to facilitate urban environmental assessment [10-11]. Urban structural units are identified as areas of relative homogeneity with respect to type and density of urban form and open space/vegetation. The method has been used to investigate urban microclimate and hydrology, building energy use, provision of green space and other environmental system properties pertinent to urban planning and design. This project *inter alia* aims to assess the suitability of the USU as a system boundary for application of material accounting tools such as MFA and MIPS, and their relevance to environmental evaluation and design.

The particular service unit selected for the streamlined MIPS analysis is the number of degrees awarded per year, recognising that education is a core function (service) of the University, alongside research.

The chosen materials are concrete and steel. These two materials have been estimated as responsible for about two-thirds of the life cycle environmental impacts of buildings as diverse as Hong Kong offices [12] and Scottish housing [13]. Broadly similar results were obtained for life cycle assessments of office buildings in Finland and the USA, [14] which included consideration of emissions of the greenhouse gas CO<sub>2</sub>; SO<sub>2</sub> (associated with acid rain); NO<sub>x</sub> (oxides of nitrogen – smog, greenhouse); and PM<sub>10</sub> (particulate matter of 10 microns or less).

The present research comprises three stages:

1. Growth in construction material stocks since the foundation of UNSW in 1950 is estimated from the construction date and gross floor area (GFA) of the 119 buildings on campus, excluding minor structures such as bus shelters and sheds.
2. The 25 year period from 1980 – which saw a doubling in student numbers – is examined in more detail. In the absence of site-specific material flow data, coefficients derived from Australian and international building industry research are applied to UNSW archival information (construction and demolition dates, GFA) to create an MFA model for concrete and steel, annualised for 1980-2004.
3. The results are compared with those obtained using primary project-based input-output data for the “North Mall Development Zone” (NMDZ) scheme, completed in 2007 (fig. 2) to validate the model. The hypothesis tested here is that information from case studies of buildings typical of a given USU should enable the validation of results obtained from application of generic coefficients to the USU as a whole.

Several qualifications must be stated at the outset, and are addressed further in the Discussion section: the construction phase alone does not address all material flows associated with the building life cycle; material flows alone do not explain all the environmental impacts of built form; and since different methods give different “absolute” impact results, outputs of the model are best understood in terms of the *relative* performance of different configurations of urban form in terms of material efficiency, resilience and intensity.

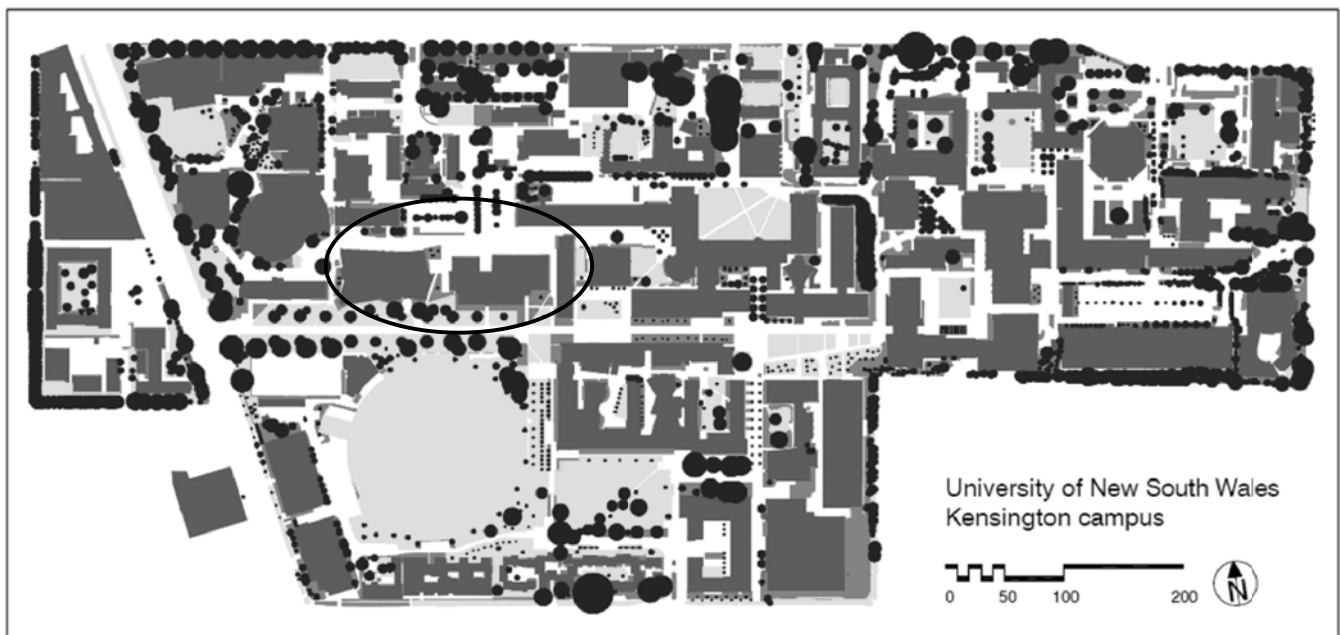

Fig. 2 UNSW Kensington campus plan, current at September 2007. Dark grey = buildings; white = paved surfaces; light grey = lawn; mid grey = shrubs; black = trees. The location of the 2004-2006 “North Mall Development Zone” project is circled.

The University of New South Wales (UNSW) is located about six kilometres from the Sydney CBD and accommodates about 40,000 full- and part-time students and 5000 teaching and operational staff. The main (Kensington) campus (Fig. 2) occupies 38 hectares. Its physical characteristics as an urban structural unit, derived through observation and from analysis of aerial photos and CAD drawings of the site, include:

- High density of built form (overall plot ratio = 1.3);
- Alignment of buildings along east-west/north-south grid;
- Orthogonal pattern of open space between buildings;
- Dense network of pedestrian and shared circulation routes;
- Buildings predominantly 4-8 storeys of concrete and brick construction;
- Significant proportion of impervious surfaces (71.2% overall, or 79.9% if the effect of the sports field to the south-west is discounted);
- Tree canopy cover of 18.9%.

The site is bounded by, and morphologically strongly differentiated from, residential areas to the east, south and west, and a major horse racing facility to the north.

## II. METHODS – SETTING UP THE MODEL

The density of structural concrete (excluding steel reinforcing) is generally given as  $2300 \text{ kg/m}^3$  [e.g. 15]. Building life cycle studies indicate the average proportion of concrete by mass in a commercial building is approximately 76-77% [12, 16-17].

The volume of concrete specified for the  $22,000 \text{ m}^2$  of new gross floor area constructed for the NMDZ project was

approximately  $10,000 \text{ m}^3$  [18] or 23,000 tonnes, equivalent to  $1.045 \text{ t/m}^2$  GFA. Taking the proportion of concrete as 76.7% [12] gives a total mass of construction materials of  $1.362 \text{ t/m}^2$  GFA, or 29,964 tonnes. The mass of steel (reinforcing and structural) specified for the project was 1850 tonnes, 6.2% of the total mass. “Other” materials, as noted above, comprise the remaining 17.1% of the total. These values are within the range cited in the literature relating to the USA, Europe and Hong Kong [12, 17, 19], and provide the input data for all three stages of the investigation. This acknowledges that the majority of the University’s buildings are of reinforced concrete construction. A number of older buildings are faced with brick; the implications of this for the stage 1 analysis are discussed in Section 6.4.4.

Two assumptions are implicit in the MIPS method: that reducing material inputs will of itself reduce waste outputs; and that materials which are recycled by definition appear as inputs to an earlier stage of a product’s life cycle. While both assumptions are technically correct, this perspective does not allow for comparative evaluations of open systems where the total mass of material inputs (and waste outputs) may be identical, but where the proportions of waste materials which are recycled *outside* the given system differ. Hence the present model is structured to account for construction and demolition waste and recycling outputs as well as material inputs.

The composition of the construction and demolition waste streams and the proportion of construction waste per square metre of constructed floor area are taken from a detailed US waste characterisation carried out by Franklin Associates [19]. A waste characterisation study from Sydney provides the data for construction and demolition recycling rates [20]. Current recycling rates are considerably higher – six years after Lawson’s report, Crowther [21] found the demolition material

recovery rate for Australian commercial buildings to be close to 70%, and it is common in 2008 to find recycling rates for major Sydney developments to be well over 80%. However, Lawson's 1994 40% figure is taken as a conservative average for the stage 2 (1980-2004) analysis, as empirical data prior to the early 1990s are unavailable. Stage 3 of the present research uses empirical waste and recycling data from the NMDZ project to populate the model.

The mass balance equations for the model are:  
 For the construction phase,

$$\sum_{j=1}^n S_j = \sum_{j=1}^n I_j - \left( \sum_{j=1}^n R_{con_j} + \sum_{j=1}^n W_{con_j} \right) \quad (4)$$

where stocks = inputs minus outputs;  $S_j$  represents the stock of material  $j$  in the building fabric,  $I_j$  is the input of  $j$  to the building project,  $R_{con_j}$  is the output of  $j$  as construction waste which is recovered, and  $W_{con_j}$  is the output of  $j$  as construction waste to landfill.

For the demolition phase,

$$\sum_{j=1}^n S_j = \sum_{j=1}^n R_{dem_j} + \sum_{j=1}^n W_{dem_j} \quad (5)$$

where stocks = outputs;  $R_{dem_j}$  and  $W_{dem_j}$  refer to demolition waste which is recycled and landfilled respectively.

The construction and demolition (C&D) recycling rate  $Rr_j$  (i.e. the mass of material  $j$  recovered as a proportion of total waste) is given by:

$$\sum_{j=1}^n Rr_j = \sum_{j=1}^n \left( \frac{R_j}{R_j + W_j} \right) = \sum_{j=1}^n \frac{R_j}{S_j} \quad (6)$$

where  $R_j$  represents the mass of the combined C&D recycling stream and  $W_j$  represents the combined mass of C&D waste to landfill.

Finally, the composition of the C&D recycling stream  $Cr_j$  for the stage 2 study is estimated by multiplying the percentage recovery of specific building materials from the literature [21] by their proportionate contribution to the overall mass of the given building type – in this case, commercial buildings [12], as specific data are unavailable for education buildings:

$$Cr_j = R_j S_j \sum_{j=1}^n S_j \Big/ S_j \sum_{j=1}^n S_j \sum_{j=1}^n R_j = R_j \Big/ \sum_{j=1}^n R_j \quad (7)$$

For each of the above equations, material densities per square metre floor space are obtained by dividing by the GFA figure for a given building or for the totality of buildings on the site. This assumes a linear mathematical relationship, which holds only where buildings are of similar surface area to volume ratio and share similar construction characteristics. In terms of the aggregated "whole of USU" (i.e. non building-specific) figures used in this investigation, and the broadly similar properties of the buildings, the assumption of linearity is considered reasonable.

The values used in constructing the model are summarised in Table 1, and the original data were obtained from UNSW annual reports, meeting minutes and related archival sources.

TABLE I  
 CONSTRUCTION MATERIAL DENSITY, WASTE AND RECYCLING COEFFICIENTS  
 USED TO CONSTRUCT THE MFA MODEL.

Variable	Value	Source
1. Mass of construction material stocks	1.362 tonnes per m <sup>2</sup> GFA (77% concrete, 10% steel, 13% other)	Extrapolation of NMDZ material input data [18], cross-referenced against recent studies from Europe [16-17] and Hong Kong [12].
2. Construction and demolition (C&D) recycling rate	40% (1994 figure used for the 1980-2004 model)	Sydney C&D waste characterisation study [20]
3. Composition of construction waste to landfill	35% concrete, 10% steel, 55% other	US C&D waste characterisation study [19]
4. Composition of demolition waste to landfill	66% concrete, 5% steel, 29% other	
5. Composition of C&D recycling stream	84% concrete, 10% steel, 6% other	Integration of Australian [21] and Hong Kong data [12]
6. Generation of non-residential construction waste	19.5 kilograms per m <sup>2</sup> GFA	US C&D waste characterisation study [19]

### III. RESULTS

#### A. Stage 1

Built form (hence input of construction materials) grew gradually over the first ten years of the University's existence, increased rapidly into the late 1970s, followed by a period of slower growth in the 1980s and another era of strong expansion in the 1990s to the present (fig. 3), reflecting demographic and socio-economic trends relating to higher education and consequent University policy responses. The total stock of building materials from 1950 to 2007 is estimated at 673,000 tonnes (kt), disaggregated as 516kt concrete, 68kt steel and 89kt "other" (bricks, glass, plaster, non-ferrous metals etc), based on a density of 1.362t per m<sup>2</sup> GFA from Table 1 (fig. 4). This gives an average intensity of 673,000t/383,400m<sup>2</sup> = 1.755 t/m<sup>2</sup> for the campus as a whole.

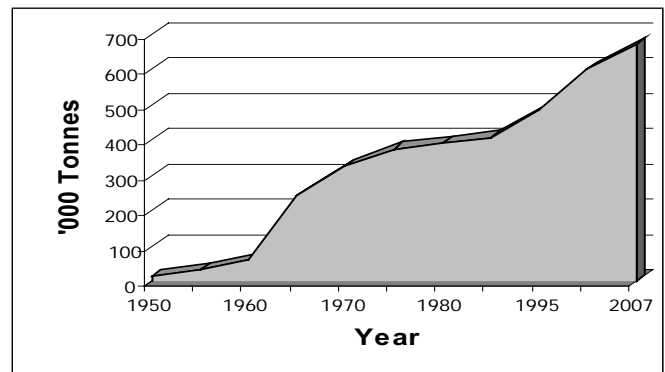

Fig. 3 Cumulative stocks of building materials for the Kensington campus, 1950-2007.

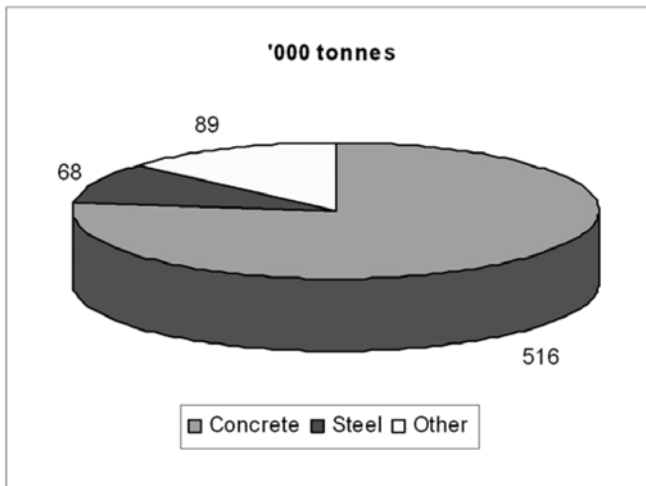

Fig. 4 Construction material stocks for the Kensington campus as at 2007.

Fig. 5 shows the annual material inputs to the campus USU, indicating the “spikes” of building activity at UNSW, particularly in the mid-1960s and late ‘90s / early 2000s.

Taking the completion of a UNSW degree as the service unit, the total material stocks in tonnes of construction materials per completed degree has declined from a high of more than 200 in the first decade following the University’s foundation to about 70 over the past decade (fig. 6), representing an increase in *material efficiency*. As discussed above, this does not include material inputs resulting from refurbishment, maintenance or operation of the buildings.

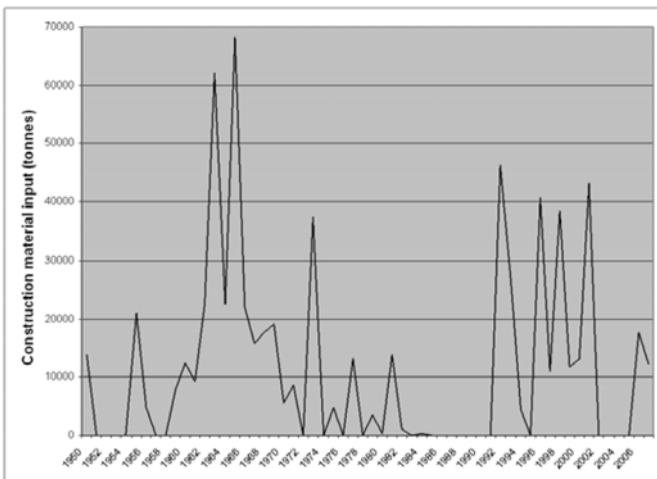

Fig. 5 Annual input of building materials to the Kensington campus, 1950-2007.

The higher cumulative values in the earlier years indicate that a minimum amount of floor space, hence mass of built form, is necessary for teaching purposes, which in the first instance is relatively independent of the number of students enrolled or graduating. There appears to be a threshold at about 1972 (2927 degrees awarded, 333 kt of construction

materials, equal to one third and one half respectively of current figures) where the relation between degrees awarded and accumulated material stocks assumes a more regular downward trend.

The annual material input per degree completed shows some significant peaks in the first 20 years of the University’s existence, when relatively few degrees were awarded but significant construction was occurring to support future growth. Smaller peaks reflect subsequent periods of development.

Comparison between figs. 5 and 6 shows the effect of economies of scale, i.e. the reduction of the MIPS value vis-à-vis quite substantial absolute material inputs as student numbers and degrees awarded increase.

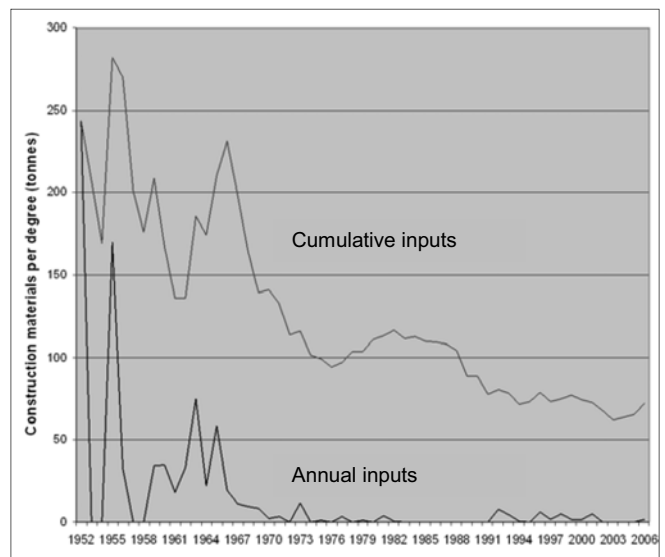

Fig. 6 Cumulative construction material inputs (stocks) per completed degree and annual material inputs per completed degree, 1952-2006.

### B Stage 2

The second stage of the investigation examines the period 1980-2004 in more detail.

Between 1980 and 2004 student enrolments rose from 18,360 to 40,000. At the same time, the stock of materials embodied in campus buildings increased by 64%. The total mass of construction material stocks per enrolled student, with some fluctuations, fell about 25% over the 25 years to 2004 (fig. 7). The average annual increase in stocks over this period (allowing for essentially zero growth from 1986 to 1991) was 10.7 kt. Stocks per student rose approximately 500 kilograms between 1995 and 2004.

In terms of the particular service unit – degrees awarded – *cumulative* building material inputs (i.e. stocks) fell from 111 tonnes to 64 tonnes from 1980 to 2004, a drop of 42% (fig. 8). Extrapolation from the trend lines suggests a lower limit is reached at about 2016, with figures of approximately 60 tonnes of material per degree awarded.

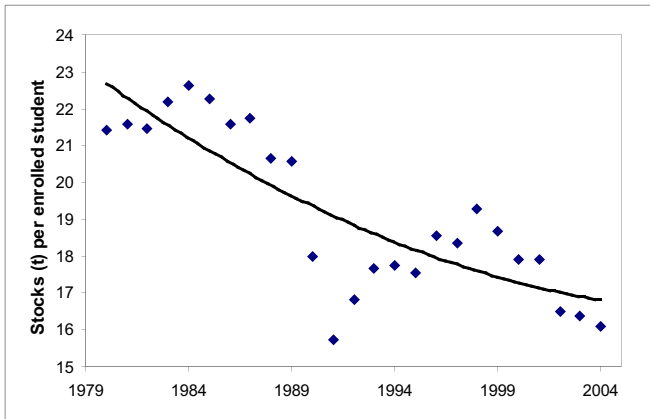

Fig. 7 Material stocks (tonnes) per enrolled student 1980-2004.

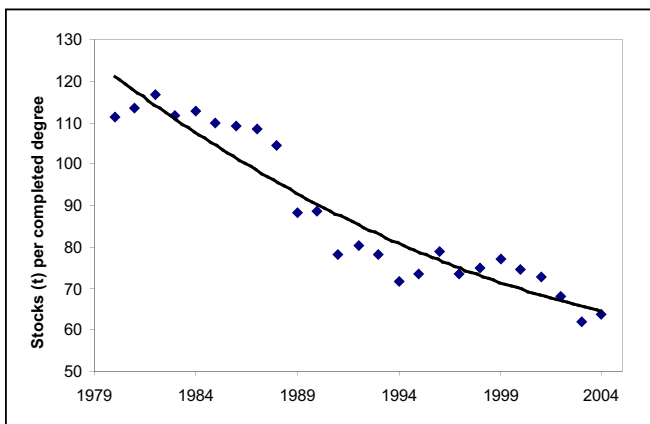

Fig. 8 Material stocks (tonnes) per degree awarded, 1980-2004.

From 1980 to 2004 nearly 270 kt of building materials were added to existing stocks. Twelve kt of demolition waste and five kt of construction waste left the campus system, of which 60% is estimated to have been landfilled, applying Lawson's [20] 40% C&D recycling rate from Table 1. The Sankey diagram below (fig. 9) shows the average annual construction material flows for 1980-2004.

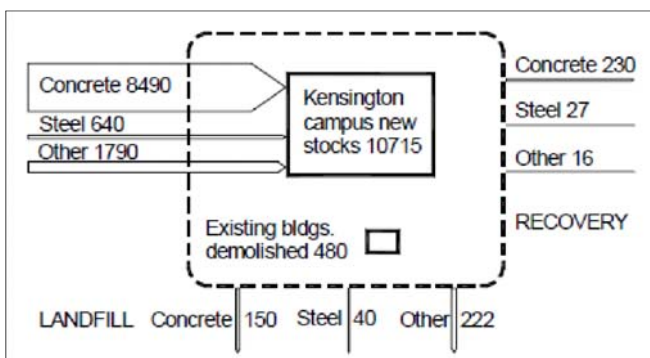

Fig. 9 Average annual material flows for the Kensington campus (tonnes), 1980-2004. The arrows indicate the relative scale of inputs and outputs, the solid boxes (also relatively scaled) represent stocks, and the dotted line represents the system boundary.

### C Stage 3

Stage 3 of the study focuses on the 3.75 hectare North Mall Development Zone, which comprises about 10% of the overall campus surface area.

Most of the land resumed for the new buildings was originally at-grade paved car parking space; impervious surfaces comprised 76% of the NMDZ before development, and 80% afterwards.

Redevelopment works carried out in the NMDZ from 2004 to 2007 involved:

- Construction of two major new buildings – a five storey, 13,000m<sup>2</sup> floor area Law Faculty building and a four storey, 9000m<sup>2</sup> floor area Analytical Centre which “wraps” around the existing 12 storey Applied Science building;
- Major refurbishments to the interiors and façades of two existing buildings, including conversion of one building from a laboratory-intensive School of Chemistry to an office and teaching space based School of Business; and
- Associated demolition of redundant office, teaching and storage facilities.

Figure 10 illustrates the scope of works.

Empirical data were provided by the NMDZ building contractor Bovis Lend Lease [18] for the overall project with respect to:

- Input of concrete;
- Input of steel reinforcing bar;
- Input of structural steel;
- Outputs of concrete, steel and “other” construction and/or demolition waste recovered, and outputs sent to landfill.

These data were used to construct a model which was annualised for 2005 to enable comparison with the results obtained for the rest of the campus through application of the coefficients described in the previous section.

This model, illustrated in the two Sankey diagrams (figs. 9 and 11) shows that the 2005 input of construction materials to the NMDZ project was 66% greater than the average construction material input for the Kensington campus between 1980 and 2004.

Further, the 2005 production of C&D waste from the NMDZ was three times the 1980-2004 campus-wide annualised average, reflecting the extent of demolition of existing structures associated with the project.

However, an average 90% of NMDZ construction and demolition waste was recycled, and the mass disposed of to landfill, comprising mainly inert material other than metal or concrete, was less than half the average annual amount of campus C&D waste landfilled between 1980 and 2005. Additionally, about 8000 tonnes of sand excavated from the NMDZ was recycled off-site in 2005 (not shown in fig. 11).

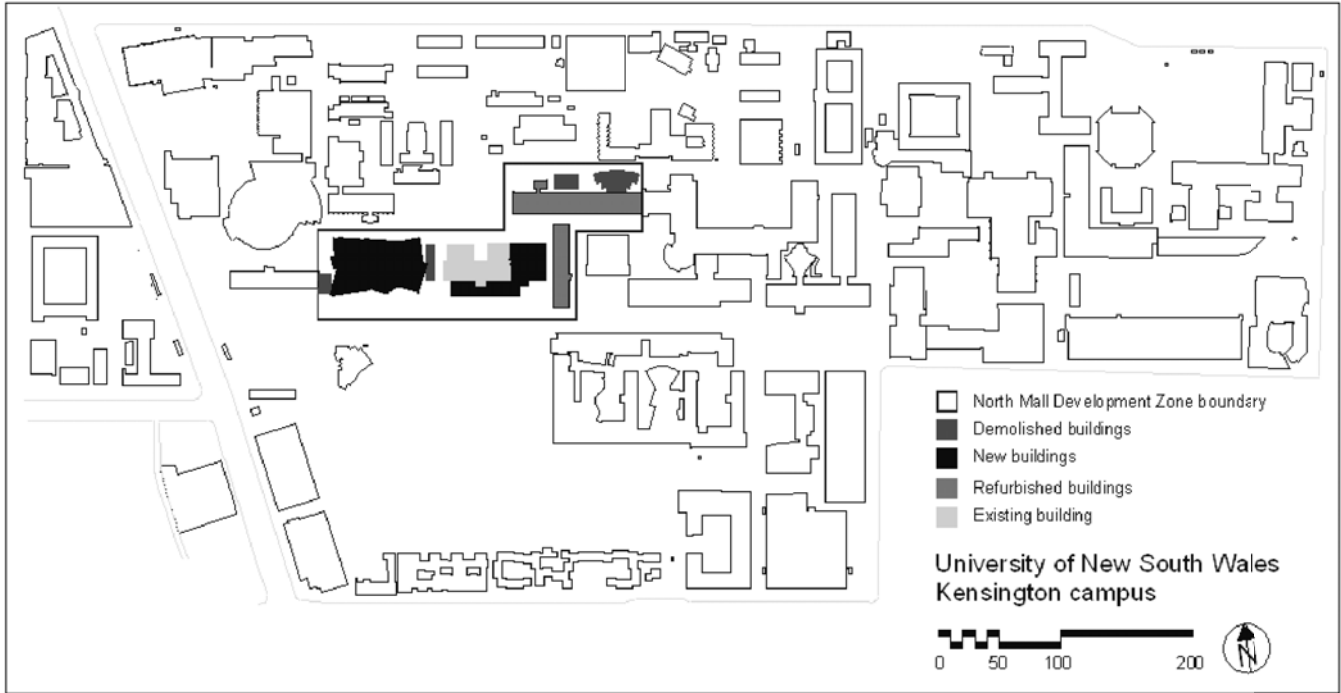

Fig.10 North Mall Development Zone project – construction of new Law Faculty building (left) and analytical centre (centre, wrapping around existing Applied Science building); refurbishment of former Heffron Chemistry building (top) to house Australian School of Business; refurbishment of Dalton building (right). Works included the demolition of several ancillary buildings.

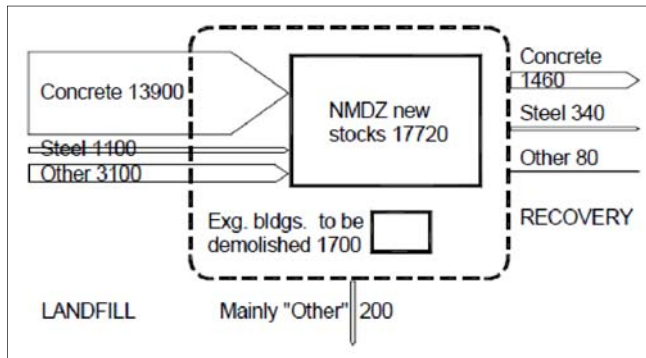

Fig. 11. Material flows for North Mall Development Zone (tonnes) for 2005.

#### IV. DISCUSSION

The above results tend to support the hypothesis that information from case studies of a subset of buildings typical of a given USU enables the validation of results obtained from application of generic coefficients to the USU overall. The NMDZ construction waste generation rate of 20 kg per m<sup>2</sup> GFA, calculated from data provided by the building contractor, is within 2.6% of the rate derived by the US EPA [19] of 19.5 kg per m<sup>2</sup> GFA (Table 1). Similarly, NMDZ empirical demolition waste figures [18] differ by only 3.3% from the GFA-derived statistics for pre-demolition building stocks. This indicates grounds for confidence in the results of this study, including potential transferability of the method to similar urban structural units such as technology parks and major hospital complexes.

Every USU exists in a socio-economic and political context, so before returning to the general discussion, some comments on the aspects of this study particular to UNSW are called for. Given that the spatial extent of the campus has remained the same, the cumulative stock of building materials is directly proportional to the intensity of built form (mass per unit area), and the cumulative stock per completed degree is directly proportional to the material efficiency (mass per service unit). The downward trend in cumulative materials (intensity) per enrolled student and degree awarded in the first half of the University's existence is clearly an artefact of the early development of the Kensington campus from its initial status as a "greenfield" site. However, the decline in stocks per student or per degree from about the mid-1970s (see figs. 7 and 8) – equivalent to an *increase* in students/degrees for a given mass of materials – reflects real trends.

On the one hand, these include external factors which have led to increased student enrolments: government policies to facilitate greater access to higher education (early 1970s, 1980s) and recruitment of fee-paying international students (1990s to the present).

On the other hand, internal factors include the University's adoption of more proactive management and utilisation of limited space, supported by more sophisticated technology. Construction techniques too have improved over this period. Latterly, as evidenced in the North Mall development, University environmental policies (themselves a reflection of the broader societal response to critical environmental issues such as climate change) have gradually begun to influence the development and management of the campus fabric [22-23].

A vast quantity of resources is stored in the built environment, and the material inputs and outputs associated with this accumulation impact proportionally on the natural environment. For example, construction and demolition accounts for about 40% of all waste going to landfill in Australia [21, 24], despite recovery rates (averaged over all building types) in excess of 60% [25].

However, a simple inventory of stocks and flows of construction materials for the University of New South Wales, or indeed for any given urban structural unit, is necessary but *insufficient* to evaluate environmental performance. Quantitative information on C&D material flows are often adequate to inform operational decision making for improved waste management, and aggregation of straightforward material accounting data across industry sectors enables the tracking of anthropogenic flows of particular substances of environmental concern, such as cadmium [5]. Accumulated stocks reflect the built form intensity and when related back to the relevant service unit, material flow data provides a measure of material efficiency. But to quantify the *overall* environmental impact of planning and design decisions, additional analysis is required.

Raw material accounting data provides inventory input to other analytical tools such as MIPS, life cycle assessment or exergy analysis to quantify the broader environmental impacts of a product or activity [2]. As noted above, a full MIPS analysis quantifies the “ecological rucksack” of the target materials to enable more detailed comparison between materials in terms of various impacts on the environment. If the application of LCA, MIPS or similar methods are directed towards informing planning and design – as distinct from a research project where impacts are determined from first principles – the use of standardised environmental impact information produced by previous first principles research will be necessary. Here the issue inevitably arises of the currency, reliability and geographical relevance of such data at the present time. The choice of impact indicators is also pertinent, and may range from consideration of the emission of greenhouse gases associated with a particular activity, product or service to a comprehensive index which combines measures of ecotoxicity, global warming potential, eutrophication, etc. If multiple indicators are used, whether separately or combined as an index, the relative *weighting* of each indicator is critical, and inevitably requires the exercise of value judgement.

Carbon dioxide emissions represent an easily measured and highly topical, albeit partial, impact indicator, calculated from *embodied energy* which represents the energy used in obtaining raw materials and subsequent processing, manufacturing and transport [26], via a streamlined LCA or life cycle energy analysis. A recent Australian study, for instance, found that emissions associated with production life cycle of typical concrete mixes ranged from 0.29 to 0.32 tonnes of carbon dioxide equivalent (CO<sub>2</sub>-e) per cubic metre, of which the chemical transformations involved in producing Portland cement were responsible for 74% to 81% [27] (it is noteworthy that the 1.45 billion tonne global production of cement is responsible for close to 5% of total global industrial

energy consumption, about 5% of anthropogenic CO<sub>2</sub> emissions and significant emissions of a range of other damaging pollutants[28]). The generation of electricity used in the production of coarse and fine aggregates was responsible for most of the remaining 19-26% of emissions. Electricity generation in the state of Victoria, where the research was conducted, depends largely on brown coal and is CO<sub>2</sub> intensive; the relevant coefficient is 1.31 kilograms CO<sub>2</sub>-e per kWh, compared with 1.06 in New South Wales, where black coal predominates, and 0.13 in Tasmania, which relies on hydro-electricity [29]. So all else being equal, emissions from NSW concrete production should be about 0.28 to 0.31 t CO<sub>2</sub>-e/m<sup>3</sup>, compared with Horvath’s estimated global average of 0.222 t CO<sub>2</sub>-e/m<sup>3</sup> of concrete [28].

So assuming a figure of 0.3 t CO<sub>2</sub>-e/m<sup>3</sup> for NSW, the total “embodied carbon”, or more accurately, embodied CO<sub>2</sub> represented by the concrete component of the University’s building stock (516,000 tonnes  $\equiv$  224,400 m<sup>3</sup>) may be estimated at 67,000 tonnes, which provides a basis for calculating the embodied emissions per student, per degree awarded, per annum inputs to the campus USU or per square metre floor space.

On the other hand, Lawson, also using Australian raw material and production data, cites a figure of 1.9 MJ/kg embodied energy for in situ concrete and 2.0 MJ/kg for precast, equivalent to 1.29 tonnes and 1.36 tonnes of embodied greenhouse emissions per cubic metre respectively [30]. In a report prepared for the US plastics industry, Franklin Associates [31] give an embodied energy value of 3 kWh/lb for concrete, equivalent to 0.66 tonnes of embodied CO<sub>2</sub> per m<sup>3</sup>. Recent LCA research from Scotland [13] suggests 1 MJ/kg, which equates to 0.68 tonnes of embodied CO<sub>2</sub> /m<sup>3</sup> of concrete, close to the US value (the NSW conversion factor of 1.06 kg CO<sub>2</sub> per kWh is used in all three examples to normalise the results). It should be noted that these studies relate to “standard” concrete, i.e. without substitution of fly ash for cement or use of recycled aggregate, both of which reduce the embodied energy.

A variety of similar, well constructed investigations may be cited, each of which presents different results. Clearly there is no consensus with respect to the embodied energy and greenhouse emissions of concrete. Comparable results have been obtained between different geographic regions, and widely divergent results within the same region, highlighting the *methodological* differences in terms of the system boundary (how far back along the production chain embodied energy/emissions are tracked), the initial assumptions made and how, when and where the life cycle inventory data have been sourced.

The situation with steel is at least as problematic. A recent review identified published embodied energy values for steel ranging from 6 to 96 MJ/kg [32]. Even allowing for the lower end being dominated by recycled steel and the upper end by energy-intensive specialty products, there is still a threefold difference ( $\approx$  20 to  $\approx$  60 MJ/kg) in reported values for general steel manufacture. The authors conclude that “The variety in embodied energy values for steel in all its forms is not related



to inaccuracies within these studies since they have very different objectives, boundaries, assumptions and methodologies. The lack of transparency and standardisation in approaches, however, renders the comparison or transferability of values between assessments unfeasible” [32: 140].

For these reasons conversion of the mass values for concrete and steel into environmental impact criteria such as embodied energy or CO<sub>2</sub> is not attempted here. It is concluded that presently available environmental impact information on construction materials is insufficiently reliable due to geographical, methodological and temporal (changing production techniques) disparities to support “absolute” determination of impacts.

On the other hand, the *relative* environmental performance of different configurations of urban form may be usefully modelled to compare design proposals, existing USUs or elements thereof. The essential provisos are that:

- A consistent methodology must be used throughout
- The initial system boundary conditions must be made explicit
- The production processes and end products must be clearly defined.

Reference was made above to the use of brick facing on a number of the older Kensington campus buildings. Clay bricks have a higher overall environmental impact than concrete by weight – for example, a typical value given for embodied energy [30], and thus CO<sub>2</sub>-e emissions, is about 25% higher than for concrete. To the extent that the inclusion of bricks reduced the amount of concrete used in some campus buildings, the annual input of concrete in the 1950s and 1960s quoted in this case study is likely to have been overstated, and the carbon emissions understated. However, insufficient empirical data on the construction of the campus buildings of that era are available to fine-tune the model, and the error is unlikely to be more than a few percentage points for the years in question.

Crucially, just as the construction phase alone does not address all material flows (for example McEvoy *et al.*[33] found that *transport* accounted for one quarter of lifecycle CO<sub>2</sub> emissions associated with construction minerals in north-west England), material flows alone cannot explain the environmental impacts of built form across the entire built environment life cycle. *Operational* energy flows are a particularly critical parameter. Depending on the estimated service life and purpose of a building, its inherent energy efficiency, the prevailing climate and occupant behaviour, the total life cycle operational energy consumed in heating, cooling, ventilation, lighting and water supply may be up to an order of magnitude greater than the energy embodied in the physical fabric [14]. Moreover, material flow information itself is incomplete unless it accounts for the widely divergent service lives of the various building elements from paints and joinery to mechanical services and façade treatments, necessitating inclusion of *repair and maintenance* in the system scope.

A robust measure of built form *resilience* necessarily

requires integration of the above factors. However, the construction/demolition cycle on its own (i.e. at the level of specificity of the building) can provide useful information on that aspect of resilience defined as *durability* or persistence. The UNSW data, for example, indicates an average annual addition to building stocks of 10,715 tonnes of construction materials and an average annual subtraction of 480 tonnes through demolition for the period 1980-2004 (fig. 9). This gives a turnover of 4.48%, equivalent to an average service life (or durability factor) of 22.3 years, which is quite low and reflects substantial redevelopment during this period of campus expansion.

Very few studies have addressed the full life cycle impacts of a building, particularly non-residential. The research by Junnila *et al.* cited above compares the environmental impacts of two office buildings in Finland and the USA for the life cycle stages of a) construction, b) use, c) maintenance and d) demolition, assuming a 50 year service life. Ignoring the absolute figures in the light of the above discussion, the *relative* contribution over these four stages for one indicator – CO<sub>2</sub> emissions – was found to be 11.3%, 83%, 5.3% and 0.4% respectively for the Finnish case study, and 9.2%, 85%, 5% and 0.8% respectively for the US building [14]. In other words, every year the building occupants are responsible for generating the equivalent of 15-18% of the CO<sub>2</sub> emissions associated with the initial construction of the building.

Scheuer *et al.* [34] define three life cycle stages: material placement, which comprises both construction and renovation; operational, which includes energy and water use; and decommissioning. Maintenance is not explicitly addressed. In a case study of a university building in Michigan, USA with a projected 75 year service life, they found that material placement accounted for just 2.2% of life cycle primary energy consumption (accounting for energy losses in conversion and transmission from source to end-user) compared to HVAC, lighting and other operational energy use (94.4%) and water services (3.3%). “In all measurements, except waste generation, operations accounted for more than 83% of inventoried environmental burdens” [34: 1061]. A MIPS analysis of resource consumption for two university buildings in Finland found that across the four categories of abiotic materials, biotic materials, water and air, building operation accounted for 33-45%, 0%, 97% and 73-86% respectively in terms of kilograms of materials per m<sup>2</sup> GFA per year over a 100-year projected service life [35].

Similar criteria apply in relation to elements of built form other than buildings. Troy *et al.* conducted a suburb-scale study of Adelaide which included embodied energy estimates for infrastructure and roads as well as for buildings, and transport energy as well as operational energy. They found that operational (including transport) energy accounted for 72%-83% of total annualised CO<sub>2</sub> emission equivalents, whereas embodied energy represented 17%-28% of the total [36]. The authors acknowledge that the breadth of the investigation necessarily limited its depth, requiring acceptance of a series of assumptions from a wide range of data sources.

Regardless of the particular metrics or methods employed, the datasets utilised or the assumptions made, it is clear that while the initial environmental impacts of the development of the built environment are high, the cumulative impacts of the day-to-day operational use of the built environment are considerably higher. The implication for the *design* process is that acceptance of higher environmental impacts at the construction stage – for example increasing material inputs to prolong service life or provide thermal mass – may considerably reduce impacts over the full life cycle of the building or other urban element. As Scheuer *et al.* point out, “the optimization of operations phase performance should still be the primary emphasis for design, until it is evident that there is a significant shift in distribution of life cycle burdens” [34: 1061]. Building rating tools such as LEED or Green Star incorporate this trade-off in their calculations.

#### V. CONCLUSIONS

Evaluation of material stocks and flows is central to an understanding of urban metabolism, and provides significant, albeit incomplete indicators of overall built environmental performance, in terms of built form *intensity* and *material efficiency*. Flows of concrete and steel represent incomplete, albeit significant, indicators of overall material flows. Data on material inputs, stocks and outputs supply the essential foundation for further analysis to determine significant environmental impacts such as emission of greenhouse gases, at the same time recognising that different methodologies and system boundaries will give widely divergent results. Linking the *service* provided by a given product to the materials used in the configuration of that product offers a way to compare, contrast and reduce the product’s environmental impact.

Streamlined approaches such as that trialled above address two major constraints familiar to built environment professionals – the lack of easily available, high quality data beyond the immediate project; and the lack of time and/or expertise to apply complex modelling techniques. This study demonstrates the potential of a streamlined method to quantify the key USU-scale material flows associated specifically with building construction and demolition, based on readily obtainable information on building typology, floor area and construction and demolition dates, to derive basic measures of built form intensity, material efficiency and resilience (durability). Cross-correlation of empirical results from the North Mall project with published data suggests the method is relatively robust.

Information on the length, diameter and composition of infrastructure segments such as water, sewerage and gas pipes, and the length, width, thickness and composition of street segments can enable inclusion of these urban elements into a whole-of-USU evaluation, although these data (as in the present case) may be more problematic to obtain. Extrapolation from Patrick Troy’s Adelaide research [36] suggests that at least in terms of embodied CO<sub>2</sub>, non-building urban elements contribute on average less than one quarter of the total for residential suburbs.

A more rigorous model of the environmental impacts of

built form requires a common framework to support the collection of detailed information on type and age of buildings [7, 37] and other urban infrastructure [38]. Such a model would also need to be *dynamic*, to record the material flows generated by the continual cycle of formation (construction and demolition) and transformation (maintenance and renovation) of the built environment.

On the other hand, the streamlined MFA/MIPS method trialled here may be used to estimate the *comparative* construction stage environmental impacts of different built form configurations both within and between urban structural units, using the properties of material efficiency, durability and intensity as indicators, as well as to evaluate the efficacy of C&D waste management practices.

The conclusion from this research is that material inputs, stocks and outputs alone can provide a first cut comparative environmental impact assessment, particularly where these are quantified in terms of the relevant unit of service. The role of built form as intermediary in delivering a given service, not the building-as-building, becomes the focus of attention, raising the obvious questions: can the service be delivered without the mediation of any building at all? And if not, what is the minimum material intensity necessary to do the job? For example, to what extent can a combination of online learning, improved space utilisation/scheduling, use of outdoor spaces and small group teaching in preference to large lecture theatres help to “dematerialise” the university campus? The opportunities to extend this research are self-evident.

#### REFERENCES

- [1] Osmond, P. *Evaluation of neighbourhood scale material flows to inform urban design*. in *Conférence Internationale Energie Solaire et Bâtiment (CISBAT)*. 2005. Lausanne, Switzerland.
- [2] Brunner, P.H. and H. Rechberger, *Practical Handbook of Material Flow Analysis*. Advanced Methods in Resource and Waste Management. 2003, Boca Raton, Florida: CRC Press/Lewis Publishers.
- [3] Kleijn, R. and E. van der Voet. *Material flow accounting*. in *Norwegian Academy of Technological Sciences 4th Seminar on Industrial Ecology*. 2001. Trondheim, Norway.
- [4] Blair, J., et al., *Affordability and sustainability outcomes: A triple bottom line assessment of traditional development and master planned communities*. 2004, Australian Housing and Urban Research Institute Sydney, Australia.
- [5] OECD. *Special Session on Material Flow Accounting - Papers and Presentations*. in *OECD Working Group on Environmental Information and Outlooks (WGEIO)*. 2000. Paris: Organisation for Economic Cooperation and Development.
- [6] Daniels, P.L. and S. Moore, *Approaches for quantifying the metabolism of physical economies; Part 1: Methodological overview*. *Journal of Industrial Ecology*, 2002. 4(4): p. 69-93.
- [7] Thuvander, L., *Towards Environmental Informatics for Building Stocks: A conceptual model for an Environmental Building Stock Information System for Sustainable Development - EBSIS<sup>SD</sup>*, in *Built Environment & Sustainable Development*. 2002, Chalmers University of Technology: Göteborg, Sweden.
- [8] Schmidt-Bleek, F., *A report by the Factor 10 Club*. 1999, Factor 10 Institute: Carnoules, France.
- [9] Spangenberg, J.H., et al., *Material flow analysis, TMR and the MIPS concept: A contribution to the development of indicators for measuring changes in consumption and production patterns*. *International Journal of Sustainable Development*, 1999. 1/2: p. 491-505.
- [10] Pauleit, S. and F. Duhme, *Assessing the metabolism of urban systems for urban planning*, in *Urban Ecology*, J. Breuste, H. Feldmann, and O. Uhlmann, Editors. 1998, Springer: Berlin. p. 65-69.

- [11] Osmond, P., *The urban structural unit: towards a descriptive framework to support urban analysis and planning*. Urban Morphology, 2010. **14**(1): p. 5-20.
- [12] Yau, R. and V. Cheng. *Developing life cycle assessment tool for buildings in Hong Kong*. in *Sustainable Building Conference 2004*. 2004. Shanghai: International Council for Research and Innovation in Building and Construction.
- [13] Asif, M., T. Muneer, and R. Kelley, *Life cycle assessment: A case study of a dwelling home in Scotland*. Building and Environment, 2007: p. 1391–1394.
- [14] Junnila, S., A. Horvath, and A.A. Guggemos, *Life-cycle assessment of office buildings in Europe and the United States*. Journal of Infrastructure Systems, 2006. **March**.
- [15] Müller, C. *Requirements on concrete for future recycling in Sustainable Construction: Concrete with Recycled Aggregates*. 1998. University of Dundee.
- [16] Kytzia, S., *Material flow analysis as a tool for sustainable management of the built environment*, in *The Real and the Virtual Worlds of Spatial Planning*, M. Koll-Schretzenmayr, M. Keiner, and G. Nussbaumer, Editors. 2003, Springer-Verlag: Berlin. p. Chapter 19.
- [17] Junnila, S., *The environmental impact of an office building throughout its life cycle*, in *Construction Economics and Management*. 2004, Helsinki University of Technology: Helsinki.
- [18] Bovis Lend Lease. 2005.
- [19] Franklin Associates, *Characterization of building-related construction and demolition debris in the United States*. 1998, US Environmental Protection Agency: Office of Solid Waste.
- [20] Lawson, B. *Buildings as glass bottles*. in *12th Annual ACSA Technology Conference, Design and Technological Innovation for the Environment*. 1994. Michigan: Association of Collegiate Schools of Architecture.
- [21] Crowther, P., *Building deconstruction in Australia*, in *Overview of Deconstruction in Selected Countries*, C.J. Kibert and A.R. Chini, Editors. 2000, International Council for Research and Innovation in Building Construction: Rotterdam. p. 14-44.
- [22] UNSW, *University of New South Wales Environment Policy*. 2005, UNSW: Sydney.
- [23] UNSW, *Environmental Management Plan 2005-2010*. 2005, University of New South Wales: Sydney.
- [24] Australian Bureau of Statistics. *Australia's Environment: Issues and Trends, 2007 2008* [cited 2008 8/3/2008]; Available from: <http://www.abs.gov.au/ausstats/>.
- [25] NSW Department of Environment and Climate Change, *NSW Waste Avoidance and Resource Recovery Strategy*. 2007, New South Wales Government: Sydney.
- [26] Treloar, G., et al., *Building materials selection: greenhouse strategies for built facilities*. Facilities, 2001. **19**(3/4): p. 139-150.
- [27] Flower, D.J.M. and J. Sanjayan, *Green house gas emissions due to concrete manufacture* International Journal of Life Cycle Assessment, 2007. **12**(5): p. 282-288
- [28] Horvath, A., *Construction materials and the environment*. Annual Review of Environment and Resources, 2004. **29**: p. 181–204.
- [29] Department of Climate Change, *National Greenhouse Accounts (NGA) Factors*. 2008, Commonwealth of Australia: Canberra.
- [30] Lawson, B., *Building materials, energy and the environment: Towards ecologically sustainable development*. 1996, Canberra: Royal Australian Institute of Architects.
- [31] Franklin Associates, *Comparative energy evaluation of plastic products and their alternatives for the building and construction and transportation industries*. 1991, Prepared for the Society of the Plastics Industry, Inc. : USA.
- [32] Menzies, G.F., S. Turan, and P.F.G. Banfill, *Life-cycle assessment and embodied energy: a review*. Proceedings of the Institution of Civil Engineers: Construction Materials, 2007. **160**(CM4): p. 134-143.
- [33] McEvoy, D., J. Ravetz, and J. Handley, *Managing the flow of construction minerals in the North West Region of England*. Journal of Industrial Ecology, 2004. **8**(3): p. 121-140.
- [34] Scheuer, C., G.A. Keoleian, and P. Reppe, *Life cycle energy and environmental performance of a new university building: modeling challenges and design implications*. Energy and Buildings, 2003. **35** p. 1049–1064.
- [35] Sinivuori, P. and A. Saari, *MIPS analysis of natural resource consumption in two university buildings*. Building and Environment, 2006. **41**: p. 657-668.
- [36] Troy, P., et al., *Embodied and operational energy consumption in the city*. Urban Policy and Research, 2003. **21**(1): p. 9-44.
- [37] Bradley, P.E. and N. Kohler, *Methodology for the survival analysis of urban building stocks*. Building Research and Information, 2007. **35**(5): p. 529-542.
- [38] Kohler, N., *Integrated Life Cycle Analysis in the Sustainability Assessment of Historical Areas, in European Union Energy, Environment and Sustainable Development Programme*. 2003, University of Karlsruhe: Karlsruhe, Germany.