

# Transmission Performance of Millimeter Wave Multiband OFDM UWB Wireless Signal over Fiber System

M. Mohamed, X. Zhang, K. Wu, M. Elfituri, A. Legnain

**Abstract**—Performance of millimeter-wave (mm-wave) multi-band orthogonal frequency division multiplexing (MB-OFDM) ultra-wideband (UWB) signal generation using frequency quadrupling technique and transmission over fiber is experimentally investigated. The frequency quadrupling is achieved by using only one Mach-Zehnder modulator (MZM) that is biased at maximum transmission (MATB) point. At the output, a frequency quadrupling signal is obtained then sent to a second MZM. This MZM is used for MB-OFDM UWB signal modulation. In this work, we demonstrate 30-GHz mm-wave wireless that carries three-bands OFDM UWB signals, and error vector magnitude (EVM) is used to analyze the transmission quality. It is found that our proposed technique leads to an improvement of 3.5 dB in EVM at 40% of local oscillator (LO) modulation with comparison to the technique using two cascaded MZMs biased at minimum transmission (MITB) point.

**Keywords**—Optical communication, Frequency up-conversion, Mach-Zehnder modulator, millimeter wave generation, radio over fiber

## I. INTRODUCTION

MILLIMETER-WAVE (mm-wave) multi-band orthogonal frequency division multiplexing (MB-OFDM) ultra-wideband (UWB) generation and distribution over single mode fiber (SMF) link have become a potential solution for wireless access networks [1]. Distribution of UWB over coaxial cable is extremely expensive and over air is limited to a range of few meters. Thus, radio over fiber (RoF) has been considered as an excellent alternative solution for distribution of UWB signals such as MB-OFDM UWB. Future wireless with features of high data rate and open network architecture is desired to satisfy the increasing demand for broadband wireless access. On the other hand, unlicensed mm-wave band has been considered a potential wireless radio frequency (RF) carrier band for the future wireless communications. To achieve high capacity access networks, IEEE 8.2.15.3c and IEEE 802.15.3a were proposed for wideband personal local access networks. In IEEE 802.15.3a, 14 channels are suggested in five groups. Each group has three channels except group five which has only two channels.

M. Mohmoud is with, the Electrical Engineering Department, University of Benghazi, Libya (e-mail: mohmoud.aujali@Benghazi.edu.ly).

X. Zhang, is with, Concordia University, Electrical and Computer Engineering Department, Montreal, Canada.

K. Wu is with, University of Montreal, Canada.

M. Elfituri is with, the College of Electrical and Electronic Technology, Benghazi, Libya, Libya.

A. Legnain is with, the Benghazi, University, Communication Research Center, Libya.

A variable throughput from 53.3 to 480 Mb/s in each channel is suggested. In IEEE 802.15.3c, 4-channels OFDM mm-wave wireless using RF of 56-67 GHz band was proposed and can deliver data of up to 7.3 Gb/s [2]. However, in order to have mm-wave wireless communications we must have mm-wave carriers. A straightforward way to obtain mm-waves is to generate them electrically, but very expensive and not cost-effective. Alternatively, when RoF is used for the distribution of mm-wave wireless signals mm-waves can be generated optically. In other words, optical generation of mm-waves may lead to cost-effective solutions compared to directly electrical generation. One solution of optical generation of mm-waves is to use optical frequency multiplication (OFM) [3-5]. The principle of optical frequency multiplication is to generate high-order optical harmonics using an electrical to optical converter, such as Mach-Zehnder modulator (MZM) driven by an RF signal. Due to nonlinear response of the electrical to optical converter, many high-order optical harmonics are generated in the optical domain. Beating of two high-order optical harmonics or/and beating of high-order optical harmonics with the optical carrier at photodetector will generate mm-waves [6]. In [6-7], transmission of UWB signals through single mode fiber based on IEEE 802.15.3a was experimentally demonstrated. An OFDM RoF system based on carrier multiplexing and interleaving for optical mm-wave generation and up-conversion was demonstrated also [8].

In this work, we propose use of one dual drive Mach-Zehnder modulator (MZM) biased at maximum transmission point (MATB). Then two strong second-order optical sidebands are generated with a frequency spacing of four times of the driving radio frequency to the MZM. Thus, this technique can be used for frequency quadrupling.

A 30-GHz mm-wave with three sub-bands of MB-OFDM UWB signals is experimentally generated and transmission over 20 km of SMF. The performance of the system is evaluated in terms of error vector magnitude (EVM) versus RF and LO modulation index (MI) of the MZM and fiber length. Also, we investigate the impact of fiber Bragg grating filter. Experimental results are confirmed by simulation and theoretical analysis.

## II. EXPERIMENTAL SETUP AND RESULTS

The system setup for the performance evaluation of the mm-wave MB-OFDM UWB over fiber is shown in Fig. 1. A continuous wave (CW) light from a tunable laser source (Anritsu MG9541A) has a wavelength of 1548.5 nm, linewidth of 800 KHz, relative intensity noise (RIN) of -155 dB/Hz and output power of 7.5 dBm.

A local oscillator (LO) sinusoidal signal of frequency 6.51 GHz and power of -5 dBm is amplified by an amplifier with 2.6-dB noise figure (NF) and 26-dB gain, and drives the MZM (dashed box in Fig. 1). The LO MI for the mm-wave generation, defined by  $m_{LO} = V_{LO}/V_{\pi}$ , and  $V_{LO}$  is the driving voltage of the local oscillator, where  $V_{\pi}$  is the modulator's switching voltage. The MZM have switching voltage of 3.8 V, an extinction ratio of 28.5 dB and insertion loss of 6 dB. The CW light is injected to the first MZM, biased at maximum transmission (MATB). Thus, two strong second-order optical sidebands are generated and have a frequency spacing that is four times of the frequency of the driving LO signal, i.e. a frequency quadrupler can be obtained as shown in Fig. 2. Also to suppress the optical carrier Fiber Bragg grating (FBG) filter has been used as shown in Fig.2. Following the optical mm-wave generation, optical single sideband modulation with MB-OFDM wireless signals is implemented. Here we use an MZM to obtain optical subcarrier modulation with MB-OFDM UWB wireless signals, as an example. This MZM has an extinction ratio of 32 dB, half wave switching voltage of 5 V, and insertion loss of 7 dB, which is driven by an MB-OFDM UWB signal generated by an arbitrary waveform generator AWG 7122B from Tektronix. The AWG 7122B provides MB-OFDM compliant modulation with three WiMedia bands allocated at the center frequency of 3.432, 3.96 and 4.488 GHz. The bit rate of 200 Mb/s is used for each band with quadrature phase shift keying (QPSK) modulation. The UWB signal is amplified by a power amplifier of 26 dB gain. A variable attenuator (VA) is used to vary the UWB power input to the MZM. Optical subcarriers carrying UWB wireless signals are present on both second-order optical sidebands that are generated by the first MZM as shown in Fig. 2.

After photodetection, the generated mm-wave MB-OFDM UWB signals centered at 29.472, 30, and 30.528 GHz. These signals are obtained due to beating of the optical carrier at -13.02 GHz with the UWB upper sidebands at 16.452, 16.98, and 17.508 GHz, which are carried by the optical carrier at +13.02 GHz. The generated mm-wave MB-OFDM UWB signals are amplified by an RF amplifier of 28 dB gain. The desired UWB signal is electrically filtered by a K&L bandpass filter (EBF) with a 3 dB bandwidth centered at frequency of 30 GHz and down-converted to 3.432, 3.96 and 4.488 GHz using a Hittite HMC-CO35 electrical mixer driven by an LO signal at 26.04 GHz and 9-dBm power, as shown in Fig. 1. Finally the EVM of the transmitted signal was measured by a high speed real-time oscilloscope SDA 11000 from LeCroy.

Open Science Index, Electronics and Communication Engineering Vol:6, No:9, 2012 publications.waset.org/123.pdf

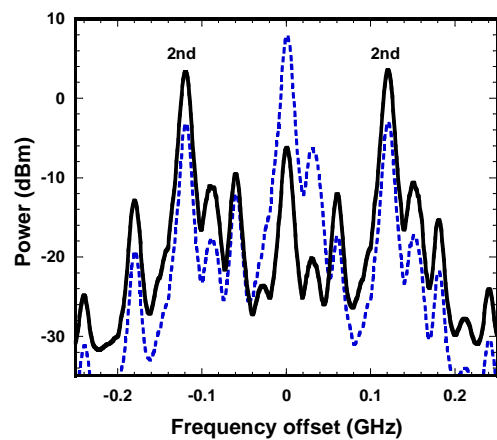

Fig. 2 Measured optical spectrum after the second MZM (dashed line) and with used of FBG (solid line)

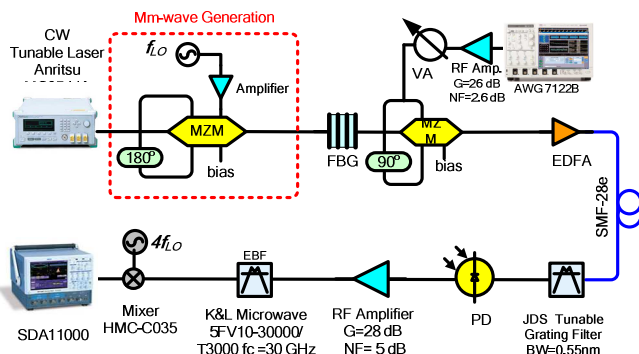

Fig. 1 Experimental setup for the mm-wave MB-OFDM UWB over fiber system. Optical mm-wave generation is used (dashed box)

The generated optical signals are transmitted over 20 km of a SMF, with fiber loss of 0.21 dB/km and chromatic dispersion of 17 ps/(nm.km). An erbium doped fiber amplifier (EDFA) is used to compensate for all optical loss and keep an optical power of 7 mW at the photodetector (PD). At the optical receiver, the optical signal is filtered by a JDS tunable optical filter, with bandwidth of 0.55 nm to reduce optical amplifier noise, and detected by a photodetector (Discovery DSC-740 with 3-dB bandwidth of 35 GHz and responsivity of 0.65 A/W).

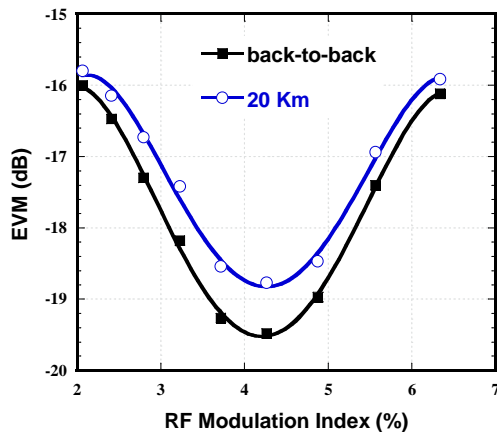

Fig. 3 Measured EVM versus RF MI for back-to-back, and after 20-km of fiber transmission

Next, we vary the RF MI of the second MZM and measure the EVM at different fiber transmission lengths as shown in Fig. 3. A minimum EVM of -19.5 and -18.8 dB is achieved at an optimum RF MI of ~4.3 % for back-to-back and 20 km of SMF, respectively. For RF MI of up to ~4.3% OFDM subcarriers suffer from relative phase shift due to fiber dispersion.

If MI is more than 4.3% the OFDM subcarriers suffer from both amplitude and phase distortion due to the combined effect of MZM response nonlinearities and fiber dispersion [12]. Moreover, when the optimum RF MI is used fiber transmission is further limited by laser phase noise converted RIN due to fiber dispersion and phase distortion induced by fiber dispersion in addition to increased optical amplifier noise due to fiber loss, compared to back to back mm-wave UWB over fiber [12].

Figure 4 shows the QPSK constellation diagram for the back-to-back and after 20 km of fiber transmission. The good quality of the constellation is an indication of suitability of the radio over fiber technique for mm-wave MB-OFDM UWB generation and distribution.

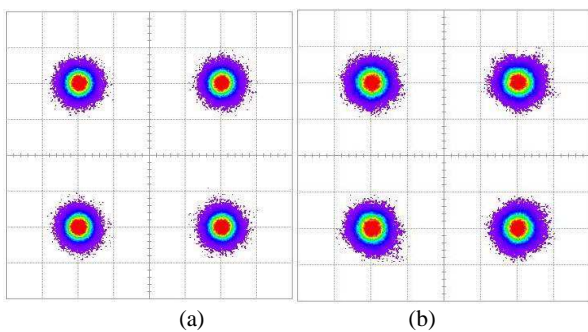
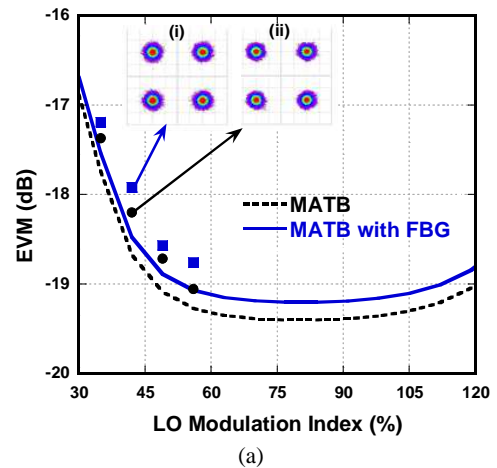

Fig. 4 Measured constellation of QPSK mm-wave MB-OFDM for (a) back-to-back and (b) after 20-km of fiber transmission

Additionally we investigate the impact of the LO MI of the first MZM by varying the power level from the LO driving source. The RF MI of the second MZM is fixed at  $\sim 4.3\%$ , the fiber length was set to 20 km and we observe the EVM at different LO power levels. In the experiments we increase the LO MI from 35 to 56% and observe that the EVM decreases from -17.4 to -19.1 dB as shown in Fig. 5 (a). Correspondingly we used the same set up to perform simulation by varying the LO MI from 30 to 120% and observe the EVM and the mm-wave MB-OFDM UWB power level.

It appears from Fig. 5 that when increasing the  $m_{lo}$  from 35 to  $\sim 45\%$  the EVM decreases from  $\sim -17.7$  to -19.6 dB and stays almost constant for up to  $\sim 100\%$ . Simulation shows good agreements with experimental results. Further increase of  $m_{lo}$  will not improve the EVM. For very low received optical power ( $m_{lo} \leq 30\%$ ) the system is limited by shot noise. For higher received optical power, the RIN becomes dominant source of noise then SNR becomes constant.

In addition, we show the performance comparison of the proposed modulation technique using MATB with MITB/MITB technique. It is clearly shown from Fig. 6 that for LO MI of up to 30% using MITB/MITB technique outperform than our technique due to the optical carrier suppressed. Conversely, when MI more than 30% is used our proposed technique has  $\sim 3.5$  dB EVM improvement at 40% of LO MI.



(a)

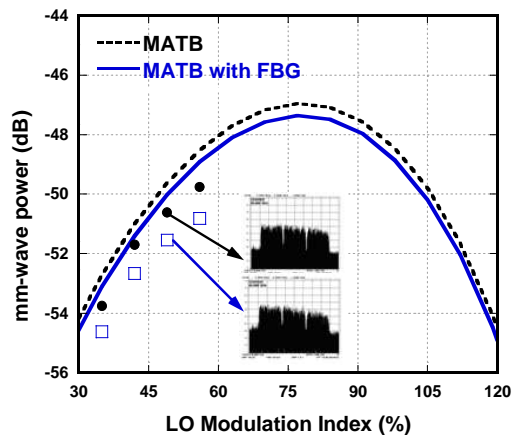

(b)

Fig. 5 Measured and simulated (a) EVM vs. LO modulation index and (b) mm-wave UWB vs. LO modulation index

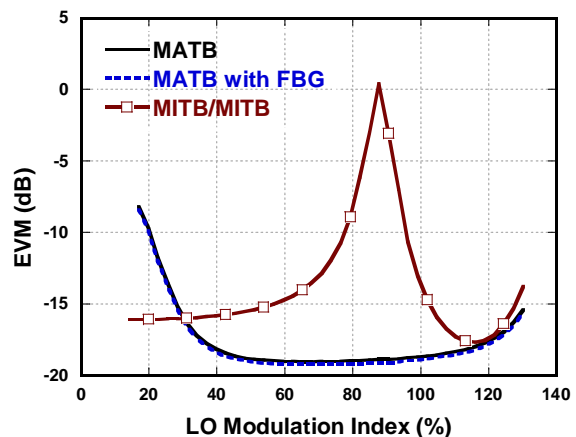

Fig. 6 Simulated EVM vs. LO MI for both techniques

### III. CONCLUSION

In this work, we experimentally have investigated the performance of mm-wave MB-OFDM UWB signal generation and transmission over fiber using a novel optical modulation technique for a frequency quadrupling. EVM has been used to evaluate the quality of transmitted signal versus LO MI of the MZMs.

It is found that proposed QAD/QAD outperforms MITB/MITB by 3.5 dB improvements in EVM at LO MI of 40%. Also, it has been found that, the best phase difference between the LO driving signal is found to be 180 degree.

#### REFERENCES

- [1] "Multi-band OFDM physical layer proposal for IEEE 802.15 task group 3a", IEEE 802.15 Working Group for WPAN, March 2004.
- [2] "Merged proposal: new PHY layer and enhancement of MAC for mm-wave system proposal", IEEE 802.15.3c working group for WPANs, Nov. 2007.
- [3] M. Mohamed, X. Zhang, B. Hraimel, Ke Wu, "Analysis of frequency quadrupling using a single Mach-Zehnder modulator for millimeter-wave generation and distribution over fiber systems," *Opt. Exp.*, vol. 16, no. 14, pp. 10786-10802, Jul. 2008.
- [4] H. Chi and J. Yao, "Frequency quadrupling and upconversion in a radio over fiber link," *J. Lightw. Technol.*, vol. 26, no. 15, Aug. 2008.
- [5] J. Zhang, H. Chen, M. Chen, T. Wang, and S. Xie "Photonic microwave frequency quadrupler using two cascaded intensity modulators with repetitious optical carrier suppression", *IEEE Photon. Techno. Lett.*, vol. 19, no. 14, pp. 1057-1059, Jul. 2007.
- [6] M. Larrode, A. Koonen, J. Vegas, and A. Ng'Oma, "Bidirectional radio-over-fiber link employing optical frequency multiplication", *IEEE Photon. Techno. Lett.* vol. 18, no.1, pp. 241-243, Jan. 2006.
- [7] M. L. Yee, V.H. Pham, Y.X Guo, L.C. Ong, B. Luo, "Performance evaluation of MB-OFDM ultra-wideband signals over single mode fiber," in *Proc. ICUWB*, pp. 674-677, Sept. 2007.
- [8] Y. Ben-Ezra, et al., "Wimedia-defined, ultra-wideband radio transmission over optical fibre," in *Proc. OFC*, pp. 1-3, Feb. 2008.
- [9] Z. Jia, J. Yu, D. Qian, G. Ellinas, G.-K. Chang, "Experimental demonstration for delivering 1-Gb/s OFDM signals over 80-km SSMF in 40-GHz radio-over-fiber access systems", *Proceedings of OFC/NFOEC 2008 JWA108*, pp. 1-3, 2008.
- [10] M. Sakib, B. Hraimel, X. Zhang, M. Mohamed, W. Jiang, K. Wu, D. Shen, "Impact of optical transmission on multiband OFDM ultra-wideband wireless system with fiber distribution," Submitted to *J. Lightw. Technol.*, Dec. 2008.