

# Analysis of SEIG for a Wind Pumping Plant Using Induction Motor

A. Abbou, H. Mahmoudi, and M. Akherraz

**Abstract**—In contrast to conventional generators, self-excited induction generators are found to be most suitable machines for wind energy conversion in remote and windy areas due to many advantages over grid connected machines. This paper presents a Self-Excited Induction Generator (SEIG) driven by wind turbine and supplying an induction motor which is coupled to a centrifugal pump. A method to describe the steady state performance based on nodal analysis is presented. Therefore the advanced knowledge of the minimum excitation capacitor value is required. The effects of variation of excitation capacitance on system and rotor speed under different loading conditions have been analyzed and considered to optimize induction motor pump performances.

**Keywords**—SEIG, Induction Motor, Centrifugal Pump, capacitance requirements, wind rotor speed.

## I. INTRODUCTION

RECENTLY considerable attention is being focused on environmentally clean and safe renewable energy sources like wind, solar, hydro etc. Many types of generator concepts have been used and proposed to convert wind power into electricity. The size of the wind turbines has increased during the past ten years, and the cost of energy generated by wind turbine has decreased. The challenge is to build larger wind turbines and to produce cheaper electricity.

In a standalone induction generator the major problem is that of guaranteeing self excitation. Self excitation of an induction machine and its sustenance depend on the appropriate combination of speed, load and terminal capacitance in relation to the magnetic non-linearity of the machine. These in turn cause certain limitations on the performance of the machine. In view of these, studies on the criteria for self excitation of an induction generator are considered to have practical significance. The excitation requirements, of an induction generator have been dealt with extensively in the literature [1].

For self excitation to occur, the following two conditions must be satisfied:

- i. The rotor should have sufficient residual magnetism.
- ii. The three capacitor bank should be of sufficient value.

Ahmed Abbou is with the Mohammed V University Agdal, Mohammadia School of Engineers, Rabat Morocco; (e-mail: [abbou@emi.ac.ma](mailto:abbou@emi.ac.ma)).

Hassan Mahmoudi is with the Mohammed V University Agdal, Mohammadia School of Engineers, Rabat Morocco (e-mail: [mahmoudi@emi.ac.ma](mailto:mahmoudi@emi.ac.ma)).

Mohamed Akherraz is with the Mohammed V University Agdal, Mohammadia School of Engineers, Rabat Morocco (e-mail: [akherraz@emi.ac.ma](mailto:akherraz@emi.ac.ma)).

If an appropriate capacitor bank is connected across the terminals of an externally driven induction machine and the rotor has sufficient residual magnetism an EMF is induced in the machine windings due to the excitation provided by the capacitor. The EMF if sufficient would circulate leading currents in the capacitors. The flux produced due to these currents would assist the residual magnetism. This would increase the machine flux and larger EMF will be induced. This in turn increases the currents and the flux. The induced voltage and the current will continue to rise until the VAR supplied by the capacitor is balanced by the VAR demanded by the machine, a condition which is essentially decided by the saturation of the magnetic circuit. This process is thus cumulative and the induced voltage keeps on rising until saturation is reached. To start with transient analysis the dynamic modeling of induction motor has been used which further converted into induction generator [2]-[4]. Magnetizing inductance is the main factor for voltage buildup and stabilization of generated voltage for unloaded and loaded conditions. The dynamic Model of Self Excited Induction Generator is helpful to analyze all characteristic especially dynamic characteristics. For the past few years the researches has been developed positively in the steady state models of three phase self excited induction generator (SEIG) [5] and proposed the steady state equivalent circuit which represents the SEIG, the critical capacitance requirement and excitation balancing has been proposed [5], [6]. Accordingly the better applicability of induction motor as a generator for isolated applications has been proposed [7]. The model was found suitable for steady state analysis but not transient analysis. Thus for analyzing the transient characteristics, dynamic model of SEIG has been developed [8] and analyzed the dynamic characteristics for various transient conditions and stability. As for the dynamic and transient operation, it was treated for no load and for different loads: resistive [9], inductive [10], induction motor [11], DC load.

In this context, this work presents generalized state-space dynamic model of a three phase SEIG developed using d-q variables in stationary reference frame for transient analysis and a method to finding the minimum value of terminal capacitance required for self-excitation. The proposed model for induction generator, load and excitation using state space approach driving by wind turbine and supplying which is coupled to a centrifugal pump in order to optimize his performances.

This paper is organized as follows: section two gives the system modeling in static and a dynamic state. In this section, a simple method is also presented and analyzed to finding the minimum value of required capacitance for self-excitation. Simulation results are discussed in section three. Finally a conclusion resumes the developed work and its features.

## II. SYSTEM MODELING AND ANALYSIS

### A. Proposed System

In the proposed system (Fig. 1), a power generation system consisting of a wind turbine with SEIG is given.

The produced power is used to supply an induction motor coupled to a centrifugal pump. As the SEIG requires reactive power for its excitation, a three phase capacitor bank is connected across its stator terminals.

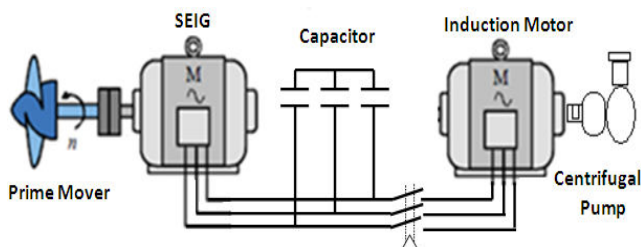

Fig. 1 Wind electric pumping system

The Induction Motor cannot be supplied unless the SEIG stator voltage build up process occurs. For this reason an operating mode switcher selects first the no load condition until the voltage build up process is accomplished. Subsequently the switcher is turned on as to connect the Induction Motor to the SEIG.

In order to analyze the performances of self excited induction generator which supplies an induction motor driving pump, a system modeling is required. Following, a steady state and dynamic modeling are presented.

### B. Steady State Analysis of Self Excited Induction Generator

Fig. 2 shows the per-phase equivalent circuit commonly used for SEIG supplying an induction motor. A three phase induction machine can be operated as a SEIG if its rotor is externally driven at a suitable speed and a three-phase capacitor bank of a sufficient value is connected across its stator terminals. When the induction machine is driven at the required speed, the residual magnetic flux in the rotor will induce a small electromotive force in the stator winding. The appropriate capacitor bank causes this induced voltage to continue to increase until an equilibrium state is attained due to magnetic saturation of the machine.

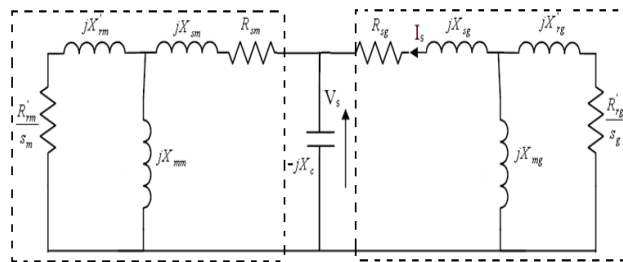

Fig. 2 Per phase equivalent circuit of self excited induction generator feeding an induction pump motor

We note: Index **g** for Induction Generator

Index **m** for Induction Motor

All circuit's parameters except the magnetizing inductance  $L_{mg}$  are assumed to be constant and insensitive to saturation.

From Fig. 2, the total current at node a may be given by:

$$V_s \cdot (Y_g + Y_c + Y_m) = 0 \quad (1)$$

where,  $Y_g$  is a total admittance induction generator,  $Y_c$  is admittance capacitive,  $Y_m$  is a total admittance induction motor

If we denote: **a** P.U. frequency and **b** P.U. speed

So:

The expression of admittance capacitive is giving by:

$$Y_c = j \frac{a}{X_c} \quad (2)$$

The induction generator admittance is expressed as:

$$Y_g = \frac{Y_{g1}(Y_{g2} + Y_{g3})}{Y_{g1} + Y_{g2} + Y_{g3}} \quad (3)$$

with:

$$Y_{g1} = \frac{1}{R_{sg} + jaX'_{sg}} \quad (4)$$

$$Y_{g2} = \frac{1}{jaX_{mg}} \quad (4)$$

$$Y_{g3} = \frac{1}{\frac{aR'_{rg}}{a-b} + jaX'_{rg}}$$

As a consequence of the symmetry of per phase equivalent circuit, the expression of total induction motor admittance  $Y_m$  can be deduced from that of  $Y_g$  by replacing the index **g** by **m**.

Therefore, under steady state self excitation, the total admittance must be zero, since:

$$V_s \neq 0 \quad \text{So} \quad (Y_g + Y_c + Y_m) = 0 \quad (5)$$

Equation (5) is divided into real and imaginary parts as:

$$\Re(Yg + Yc + Ym) = 0 \quad (6)$$

$$\Im(Yg + Yc + Ym) = 0 \quad (7)$$

Separating real and imaginary Parts of the Yg, we obtain:

$$Yg = \frac{1}{R_G + jX_G} = \frac{R_G}{R_G^2 + (X_G)^2} - j \frac{X_G}{R_G^2 + (X_G)^2} \quad (8)$$

with:

$$R_G = R_{sg} + \frac{a(a-b)R'_{rg} X_{mg}^2}{(a-b)^2 (X'_{rg} + X_{mg})^2 + R'_{rg}{}^2} \quad (9)$$

$$X_G = aX_{sg} + \frac{aX_{mg}((a-b)^2 X'_{rg} (X_{mg} + X'_{rg}) + R'_{rg}{}^2)}{(a-b)^2 (X'_{rg} + X_{mg})^2 + R'_{rg}{}^2} \quad (10)$$

To simplify the equations and a nominal condition of the induction motor, we can write:

$$Ym = \frac{1}{R_M + jX_M} = \frac{R_M}{R_M^2 + (X_M)^2} - j \frac{X_M}{R_M^2 + (X_M)^2} \quad (11)$$

$R_M$  and  $X_M$  are expressed with the induction motor parameters.

Equations (6) and (7) give:

$$\frac{R_G}{R_G^2 + (X_G)^2} + \frac{R_M}{R_M^2 + (X_M)^2} = 0 \quad (12)$$

$$\frac{a}{Xc} - \frac{X_G}{R_G^2 + (X_G)^2} - \frac{X_M}{R_M^2 + (X_M)^2} = 0 \quad (13)$$

It is noted that (12) is independent of Xc and the only variable is the per unit frequency  $a$ .

Once the value of  $a$  has been determined then Xc can be determined using (13).

For no load operation  $R_M = \infty$  and  $X_M = 0$

Substituting  $R_M = \infty$  and  $X_M = 0$  in (12):

$$R_{sg} + \frac{a(a-b)R'_{rg} X_{mg}^2}{R'_{rg}{}^2 + (a-b)^2 (X'_{rg} + X_{mg})^2} = 0 \quad (14)$$

On simplification, it yields the following:

$$a_{\max} = b - \frac{b}{2} \left[ \frac{1 - \sqrt{1 - \left(\frac{b_c}{b}\right)^2}}{1 + \frac{R_{sg}}{R'_{rg}} \left(1 + \frac{X'_{rg}}{X_{mg}}\right)^2} \right] \quad (15)$$

where  $b_c$  is given by:

$$b_c = \frac{2R_{sg}}{X_{ms}} \sqrt{R'_{rg} + \left(1 + \frac{X'_{rg}}{X_{mg}}\right)^2} \quad (16)$$

Substituting  $R_M = \infty$  and  $X_M = 0$  in (13):

$$Xc = a_{\max}^2 \left[ X_{sg} + \frac{aX_{mg}((a-b)^2 X'_{rg} (X_{mg} + X'_{rg}) + R'_{rg}{}^2)}{(a-b)^2 (X'_{rg} + X_{mg})^2 + R'_{rg}{}^2} \right] \quad (17)$$

Hence  $C_{\min}$  is given by:

$$C_{\min} = \frac{1}{2\pi 50 a_{\max}^2 \left( X_{sg} + \frac{aX_{mg}((a-b)^2 X'_{rg} (X_{mg} + X'_{rg}) + R'_{rg}{}^2)}{(a-b)^2 (X'_{rg} + X_{mg})^2 + R'_{rg}{}^2} \right)} \quad (18)$$

Thus,  $C_{\min}$  is inversely proportional to the square of the p.u. machine frequency. The value of  $C_{\min}$  determined from (18) is just sufficient to have self-excitation under steady state. If a terminal capacitor  $C = C_{\min}$  is used and the generator is started from rest, the voltage build up will not take place.

Thus in practice, terminal capacitor  $C$  having a value somewhat greater than  $C_{\min}$  should be selected to ensure self-excitation.

### C. SEIG Modeling

The model for the SEIG is similar to that of the induction motor. To model the SEIG effectively, the parameters should be measured accurately. The parameters used in the SEIG can be obtained by conducting tests on the induction generator when it is used as a motor. The traditional tests used to determine the parameters are the open circuit (no load) test and the short circuit (locked rotor) test.

In this paper the d-q model is used because it is easier to get the complete solution, transient and steady state, of the self excitation. The parameters given in the d-q equivalent circuit shown in Fig. 3 are obtained by conducting parameter determination tests on the above mentioned induction machine. As it is a wound rotor induction machine there is no variation of rotor parameters with speed.

The parameters obtained from the test at rated values of voltage and frequency are  $L_{sg} = L'_{rg} = 229\text{mH}$ ,  $L_{mg} = 217\text{mH}$ ,  $R_{sg} = 2.2\Omega$ ,  $R'_{rg} = 2.68\Omega$ . For motoring application these parameters can be used directly. However, for SEIG application the variation of  $L_{mg}$  with voltage should be taken into consideration.

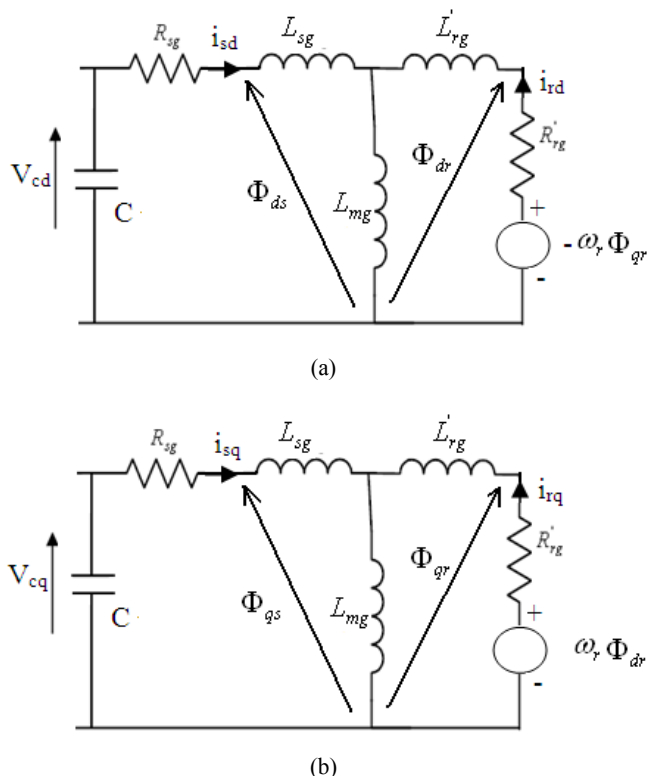

Fig. 3 d-q model of SEIG at no load a) d-axis b) q-axis

$$\begin{bmatrix} R_g + pL_{sg} + \frac{1}{pC} & 0 & pL_{mg} & 0 \\ 0 & R_g + pL_{sg} + \frac{1}{pC} & 0 & pL_{mg} \\ pL_{mg} & -\omega L_{mg} & R'_{rg} + pL'_{rg} & -\omega L'_{rg} \\ \omega L_{mg} & pL_{mg} & \omega L'_{rg} & R'_{rg} + pL'_{rg} \end{bmatrix} \begin{bmatrix} i_{sq} \\ i_{sd} \\ i_{rq} \\ i_{rd} \end{bmatrix} = \begin{bmatrix} 0 \\ 0 \\ 0 \\ 0 \end{bmatrix} \quad (19)$$

The initial conditions for self-excitation, namely the remanent magnetic flux in the rotor and/or the initial charge in the capacitors are not considered because they will be cancelled when both sides are differentiated.

Derived from (19) and including initial conditions, i.e. initial voltage in the capacitors and remanent magnetic flux in the core, one can obtain the following differential equation [5]:

$$pI = A.I + B \quad (20)$$

where:

$$I = \begin{bmatrix} i_{sq} \\ i_{sd} \\ i_{rq} \\ i_{rd} \end{bmatrix} \quad B = \frac{1}{L} \begin{bmatrix} L_{mg} K_q - L'_{rg} V_{cq} \\ L_{mg} K_d - L'_{rg} V_{cd} \\ L_{mg} V_{cq} - L_{sg} K_q \\ L_{mg} V_{cd} - L_{sg} K_d \end{bmatrix}$$

$$A = \frac{1}{L} \begin{bmatrix} -L'_{rg} R_{sg} & -L_{mg}^2 \omega_r & L_{mg} R'_{rg} & -L_{mg} L'_{rg} \omega_r \\ L_{mg}^2 \omega_r & -L_{sg} R_{sg} & L_{mg} L'_{rg} \omega_r & L_{mg} R'_{rg} \\ L_{mg} R_{sg} & L_{sg} L_{mg} \omega_r & -L_{sg} R'_{rg} & L_{sg} L'_{rg} \omega_r \\ -L_{sg} L_{mg} \omega_r & L_{mg} R_{sg} & -L_{sg} L'_{rg} \omega_r & -L_{sg} R'_{rg} \end{bmatrix}$$

$$\text{and } L = L_{sg} L'_{rg} - L_{mg}^2$$

$K_d$  and  $K_q$  are constants which represent the initial induced voltages along the d-axis and q-axis respectively due to remanent magnetic flux in the core.

To approach the characteristics of the induction machine (All the experimental points  $L_{mg}$ ) by a mathematical function, we used an approximation method.

Fig. 4 has shown the experimental curve of the mutual inductance  $L_{mg}$ :

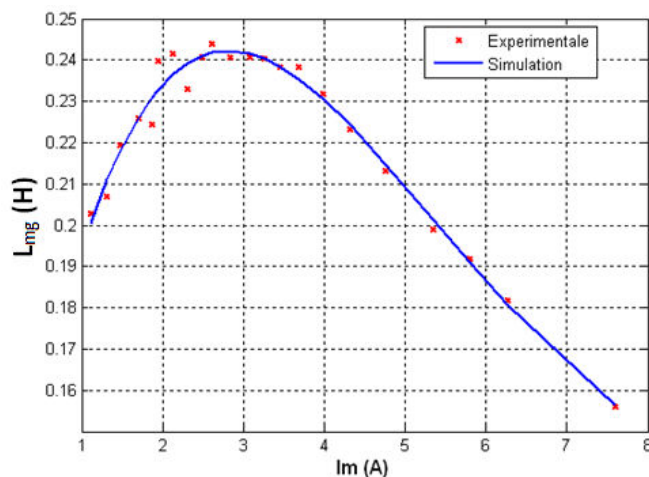

Fig. 4 Magnetizing inductance of the induction generator

The magnetizing inductance is measured as a function of the magnetizing current by performing an open circuit test for which the machine is driven at synchronous speed and a variable voltage source is applied to the stator (Fig. 4).

#### D. Induction Motor Model

The classical equations of the Induction Motor in the Park model are written follows:

$$\begin{cases} V_{ds} = R_{sm} i_{ds} + \frac{d\Phi_{ds}}{dt} - \omega_s \Phi_{qs} \\ V_{qs} = R_{sm} i_{qs} + \frac{d\Phi_{qs}}{dt} + \omega_s \Phi_{ds} \\ V_{dr} = 0 = R_{rm} i_{dr} + \frac{d\Phi_{dr}}{dt} - (\omega_s - \omega) \Phi_{qr} \\ V_{qr} = 0 = R_{rm} i_{qr} + \frac{d\Phi_{qr}}{dt} + (\omega_s - \omega) \Phi_{dr} \end{cases} \quad (21)$$

$$\begin{cases} \Phi_{ds} = L_{sm} i_{ds} + L_{mm} i_{dr} \\ \Phi_{qs} = L_{sm} i_{qs} + L_{mm} i_{qr} \\ \Phi_{dr} = L_{rm} i_{dr} + L_{mm} i_{ds} \\ \Phi_{qr} = L_{rm} i_{qr} + L_{mm} i_{qs} \end{cases} \quad (22)$$

$V_{ds}, V_{qs}, V_{dr}, V_{qr}, i_{ds}, i_{qs}, i_{dr}, i_{qr}$  are respectively the voltage and current output of the Motor in the Park model.

$R_{rm}, R_{sm}, L_{sm}$  and  $L_{rm}$  are respectively the resistance and inductances of the rotor and stator winding,  $\omega = p\Omega_{mec}$  is the rotor speed,  $p$  is the number of pole pair.

The electromagnetic torque is given by the following formula:

$$T_{em} = p(\Phi_{ds} i_{qs} - \Phi_{qs} i_{ds}) \quad (23)$$

### E. Pump Model

The mechanical power of centrifugal pump is giving by:

$$P_{mec\_pump} = T_{pump} \Omega_{rm} = K \Omega_{rm}^2 \quad (24)$$

where the  $T_{pump}$  is the load torque of the pump and  $K$  is a coefficient computed by:

$$K = \frac{T_{pumpMAX}}{\Omega_{rMAX}} \quad (25)$$

$T_{pumpMAX}$  is the maximum rated torque and  $\Omega_{rMAX}$  is the maximum rated mechanical motor speed.

The mechanical equation that describes this system is:

$$J_m \frac{d\Omega_{rm}}{dt} = T_{em} - T_{pump} \quad (26)$$

### III. DYNAMIC RESULTS

The induction machine used as the SEIG in this investigation is a three-phase squirrel cage induction generator with specification: 3Kw, 220/380V, 12.4/7.2A, 50Hz.

This later supplies an induction motor: 1.5Kw, 220/380V, 8/5.6A, 50Hz.

The fixed parameters of both induction machines used in this proposed system are:

$$\begin{aligned} R_{sg} &= 2.2\Omega, R'_{rg} = 2.68\Omega, L_{sg} = L'_{rg} = 229\text{mH}, L_{mg} = f(I_m), p_g = 2 \\ R_{sm} &= 4.85\Omega, R'_{rm} = 3.80\Omega, L_{sm} = L'_{rm} = 274\text{mH}, L_{mm} = 258\text{mH}, \\ p_m &= 2. \end{aligned}$$

The residual magnetism in the machine is taken into account in simulation process without which it is not possible for the generator to self excite. Initial voltage in the capacitor is considered.

TABLE I

VARIATION OF FREQUENCY WITH SPEED BASE SPEED=1500RPM			
SPEED (PU)	FREQUENCY (PU)	SPEED (PU)	FREQUENCY (PU)
1	0.9987	0.6	0.5978
0.9	0.8986	0.5	0.4974
0.8	0.7984	0.4	0.3967
0.7	0.6982	0.3	0.2955

The critical speed  $b_c$  (16) is the speed below which the machine will not operate. For the given machine parameters  $R_{sg}, R'_{rg}, X_{sg}, X'_{rg}$ , speed  $b$  and magnetizing reactance  $X_{mg}$ , (15) was solved to obtain the p.u. frequency  $a_{max}$  corresponding to self – excitation and the critical speed  $b_c$  was obtained from (16), for each value of p.u speed, the frequency  $a_{max}$  was be calculated. Table I shows the variation of  $a_{max}$  for different p.u speeds  $b$  with initial value of the reactance  $X_{mg}=68.138\Omega$ .

### A. Effect of the Capacitance Value

In order to determine the suitable operation mode of SEIG and Induction motor system driven by wind turbine, the effect of the capacitance value on the stator voltage waveform is studied. The following steps resume a few applied tests to verify the system robustness:

*First step:* The rotor speed of SEIG is increased from zero at 0.1sec to 955 rpm at 0.5 sec.

*2nd step:* The motor pump starts operation after a delay of 4s. *Step 3:* An additional load torque pump is applied at 6sec.

*Step 4:* The rotor speed of SEIG is decreased and attains 815rpm in 8sec.

The minimum value of the calculated capacitor under this test conditions is to 220 $\mu$ F.

Figures show that when the generator is excited with increasing values of capacitance, the steady state value of voltage and current generated has been increased. For small values of capacitance ( $C=240\mu$ F), there is a risk of losing the full excitation especially during transitional regimes (motor started, decrease rotor speed).

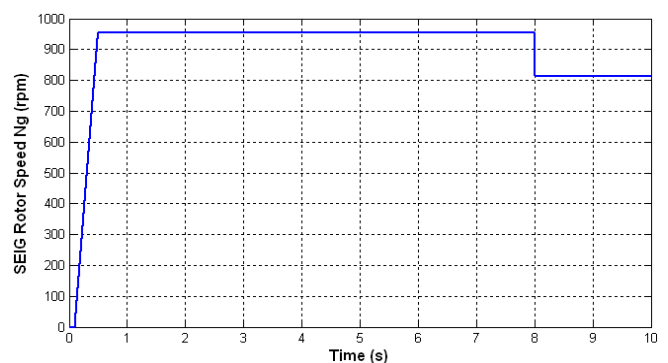

Fig. 5 Evolution of SEIG rotor speed

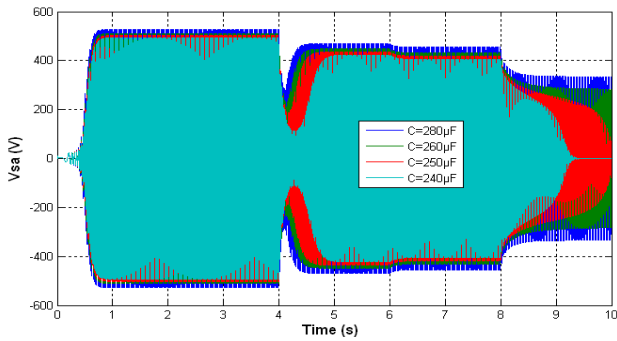

Fig. 6 SEIG stator voltage variation at different capacitance

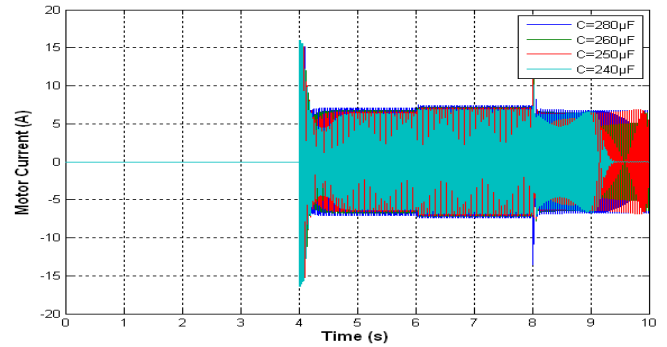

Fig. 10 Induction motor current variation at different capacitance

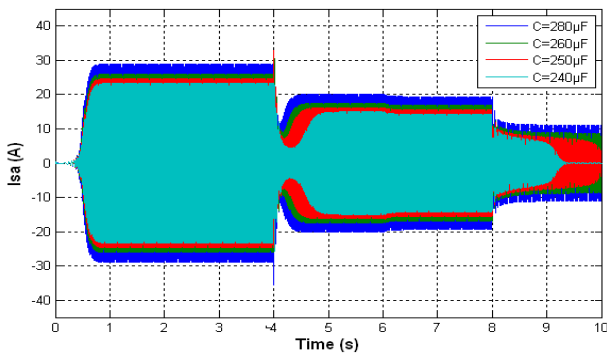

Fig. 7 SEIG stator current variation at different capacitance

From these figures, we see that the good performance of the motor pump are obtained with capacitance value equal to  $260\mu\text{F}$  with maintaining the full excitation and suitable values of the voltage and current generated.

### B. Effect of SEIG Rotor Speed Variation with Optimal Capacitance

In order to verify the effect of speed rotor variation about functioning of the studied system, the generator is excited with capacitance value  $C_{opt}=260\mu\text{F}$  and the rotor speed is increased from zero to  $N_g$  in 1sec. At  $t=4\text{sec}$ , the motor pump is started.

The following figures show that the voltage and current generated increases as the speed increases. The best speed that is suitable for rated motor pump is around at 1000rpm.

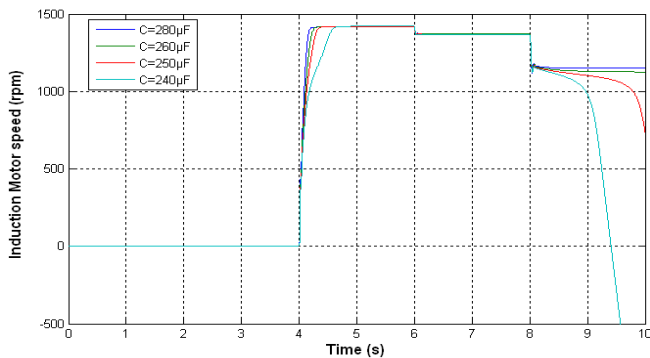

Fig. 8 Induction motor speed variation at different capacitance

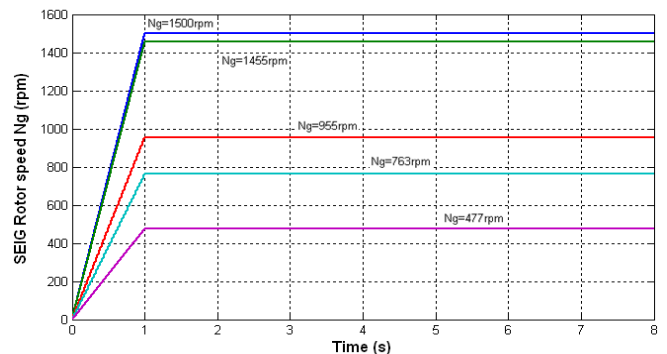

Fig. 11 Evolution of SEIG rotor speed

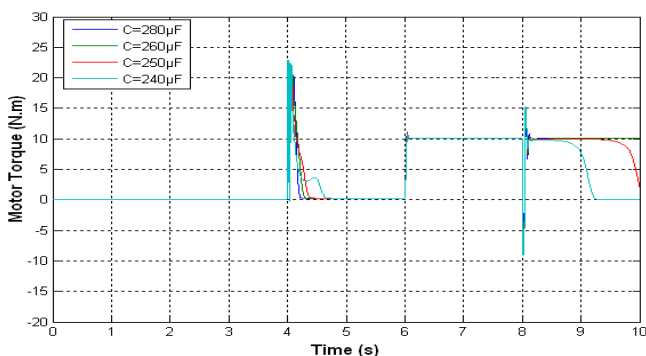

Fig. 9 Induction motor Torque variation at different capacitance

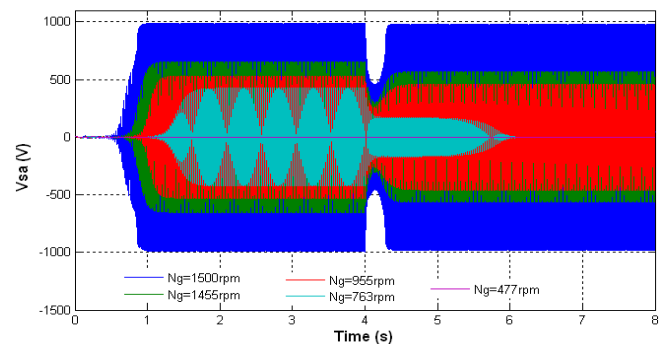

Fig. 12 SEIG stator voltage variation at different rotor speed  $N_g$

With the slower machine it takes more time to full excitation. The full self excitation time is reduced from 1.7

sec to 0.9 sec, when the rotor speed increased from 763rpm to 1500rpm.

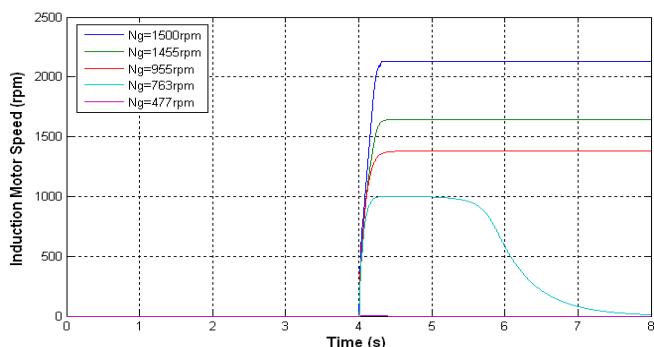

Fig. 13 Induction motor speed variation at different rotor speed Ng

#### IV. CONCLUSION

This paper has presented generalized state space dynamic modeling of three phases self excited induction generator. An effect of an excitation capacitor on the steady state behavior of the SEIG driven by wind turbine and supplying an induction motor which is coupled to a centrifugal pump is studied to enable selection of optimal capacitance value for a giving wind rotor. The approach presented enhances the transient characteristics with the variations of load torque, excitation and speed. Performance of SEIG coupled to induction motor system is analyzed during initial self excitation, load torque switching, varying prime mover speed and excitation capacitance. It has been shown that a proper combination of speed and terminal capacitance can only guarantee self excitation in induction generator and good functioning for motor pump. The experimental setup used to determine the magnetization characteristic can be used to verify the obtained curves and capacitances values calculated.

#### APPENDIX

TABLE II  
INDUCTION GENERATOR PARAMETERS

Rated power	3 KW
Voltage	380V Y
Frequency	50 Hz
Pair pole	2
Rated speed	1400 rpm
Stator resistance	2.2 $\Omega$
Rotor resistance	2.68 $\Omega$
Inductance stator	229 mH
Inductance rotor	229 mH
Mutual inductance	217 mH
Moment of Inertia	0.046 kg.m <sup>2</sup>

TABLE III  
INDUCTION MOTOR PARAMETERS

Rated power	1.5 KW
Voltage	380V Y
Frequency	50 Hz
Pair pole	2
Rated speed	1440 rpm
Stator resistance	4.85 $\Omega$
Rotor resistance	3.805 $\Omega$
Inductance stator	274mH
Inductance rotor	274 mH
Mutual inductance	258 mH
Moment of Inertia	0.031 kg.m <sup>2</sup>

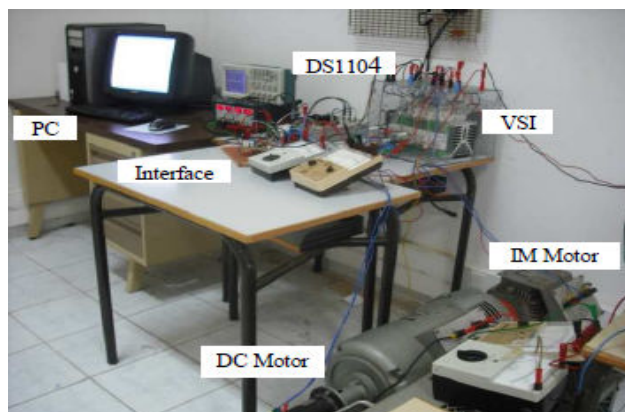

Fig. 14 Photograph of the experimental Setup test

#### REFERENCES

- [1] C. Chakraborty, S.N. Bhadra, A.K. Chattopadhyay, "Excitation requirements for standalone three phase induction generator", IEEE Transactions on Energy Conversion, Vol.13, No. 4, 1998, pp 358-365.
- [2] G. Rains and O P. Malik, "Wind energy conversion using a self-excited induction generator," IEEE Transactions on Power Apparatus and Systems. vol.102, no. 12, 1983, pp. 3933-3936.
- [3] A.H. Al-Bahrani "Analysis of self-excited induction generators under unbalanced conditions." Electric Machine and Power Systems. vol 24.1996, pp 117-129.
- [4] M. Radic, Z. Stajic, D. Arnautovic, " critical speed-capacitance requirements for self-excited induction generator", Automatic Control and Robotics Vol. 8, No 1, 2009, pp. 165 – 172.
- [5] A. Kishore, G. Satish Kumar, " dynamic modeling and analysis of three phase self-excited induction generator using generalized state-space approach", International Symposium on Power Electronics, Electrical Drives, Automation and Motion, SPEEDAM 2006, pp 52-59.
- [6] Dawit S Eyaum Colin Grantham, and Muhammed Fazlur Rahman, "The dynamic characteristics of an isolated self-excited induction generator driven by a wind turbine", IEEE, Transaction on Industry applications, Vol. 39.No.4 , July/August 2003 pp 936 - 944.
- [7] R. Kumar T., V. Agarwal, P.S.V. Nataraj, " A Reliable and Accurate Calculation of Excitation Capacitance Value for an Induction Generator Based on Interval Computation Technique", International Journal of Automation and Computing 8(4), November 2011, pp 429-436.
- [8] Li Wang, Chaing-Huei Lee , "A novel analysis on the performance of an Isolated self excited induction generators," IEEE Trans. on Energy conversion June 1993, vol.12, No.2.
- [9] Sridhar, L., B. Singh, C. S. Jha, and B. P. Singh, "Analysis of a self excited induction generator feeding induction motor load," IEEE Transaction on Energy Conversion, Vol. 9, No. 2, June 1994.
- [10] S. Boora, " On-Set Theory of Self-Excitation in Induction Generator", International Journal of Recent Trends in Engineering, Vol 2, No. 5, November 2009, pp 325-330.
- [11] M. Ouali, M. Ben ali Kamoun, M. Chaabene, " Investigation on the Excitation Capacitor for a Wind Pumping Plant Using Induction Generator", Smart Grid and Renewable Energy, 2011, 2, pp 116-125.