

# Thermal treatments & characteristics study on unalloyed structural (AISI 1140) steel

S. S. Sharma, P. R. Prabhu, Rajagopal Chadaga

**Abstract**—The main emphasis of metallurgists has been to process the materials to obtain the balanced mechanical properties for the given application. One of the processing routes to alter the properties is heat treatment. Nearly 90% of the structural applications are related to the medium carbon alloyed steels and hence are regarded as structural steels. The major requirement in the conventional steel is to improve workability, toughness, hardness and grain refinement. In this view, it is proposed to study the mechanical and tribological properties of unalloyed structural (AISI 1140) steel with different thermal (heat) treatments like annealing, normalizing, tempering and hardening and compared with as brought (cold worked) specimen. All heat treatments are carried out in atmospheric condition. Hardening treatment improves hardness of the material, a marginal decrease in hardness value with improved ductility is observed in tempering. Annealing and normalizing improve ductility of the specimen. Normalized specimen shows ultimate ductility. Hardened specimen shows highest wear resistance in the initial period of slide wear where as above 25KM of sliding distance, as brought steel dominates the hardened specimen. Both mild and severe wear regions are observed. Microstructural analysis shows the existence of pearlitic structure in normalized specimen, lath martensitic structure in hardened, pearlitic, ferritic structure in annealed specimen.

**Keywords**—annealing, hardness, Heat treatment, normalizing, wear

## I. INTRODUCTION

STEEL is the alloy of Iron and carbon. Carbon is present in combined form like cementite. The maximum limit of carbon in steel is 2% by weight. The AISI 1140 steel is the basic medium carbon steel and it contains nearly 0.38 wt % of carbon [1]-[4]. The equilibrium phases at room temperature consist of proeutectoid ferrite and pearlite. The wt % of pearlite is nearly 25 and proeutectoid ferrite is nearly 75%.

Steels can be subjected to variety of conventional heat treatments like annealing, normalizing, hardening and tempering. The combination of heating and cooling operations applied to a metal or alloy in the solid state is termed as heat treatment. The high temperature phase austenite in steel has the property to transform into variety of room temperature

phases like coarse pearlite, sorbite, troostite, bainite & martensite depending upon the cooling cycle [5] [6]. These phases may be the decomposition products like ferrite & cementite or it may be super saturated solid solution known as martensite [7]. Depending upon the plate thickness and interlamellar spacing between ferrite and cementite phases in pearlite, the property of steel can be altered. The plate thickness and interlamellar spacing between ferrite and cementite is larger, coarser is the pearlite and ferrite, hence ductility increases. This is possible by slow cooling of the austenitic phase to room temperature, accordingly the treatment is known as annealing.

If the austenitic phase is cooled at a slightly faster rate, so that the decomposition of austenite by the eutectoid reaction is possible to form medium or fine pearlite with increased weight percentage of eutectoid mixture (pearlite), the treatment is known as normalizing. Here the degree of dispersion of ferrite and cementite in pearlite increases to improve the machinability with finer grain size. The normalized steel contains nearly 50 wt % of pearlite and 50 wt % of proeutectoid ferrite. If the austenitic phase is cooled in such a way that the cooling rate is greater than or equal to critical cooling rate (CCR), the transformed phase is termed as martensite. It is supersaturated single phase with body centered tetragonal (BCT) structure. The BCT structure has got a  $c/a$  ratio higher with more trapped carbon in the lattice. So hardness and strength increase with considerable amount of thermal stresses because of quenching severity. To decrease the  $c/a$  ratio of BCT martensite, to improve toughness, to convert retained austenite into stable phases; to saturate the nonequilibrium BCT martensitic structure and to minimize the thermal stresses induced during hardening, tempering treatment is given. Depending upon the tempering temperature and duration, the improvement in toughness is possible with the sacrifice of hardness and strength [8]-[11]. Table 1 shows the chemical composition of the AISI 1140 steel used in this study.

TABLE I  
ALLOYING ELEMENTS IN AISI 1140 STEEL

Element	% wt	Element	% wt
Carbon	0.38	Sulphur	0.034
Silicon	0.17	Copper	0.03
Manganese	0.77	Aluminium	0.02
Phosphorus	0.03	Nickel	0.01

Dr. S. S. Sharma, Professor, Department of Mechanical & Manufacturing Engineering, Manipal Institute of Technology, Manipal - 576104 (Ph: 0820 2925462; Fax: 0820 292571071; e-mail: sharmass\_mit@yahoo.co.in).

P. R. Prabhu, Lecturer, Department of Mechanical & Manufacturing Engineering, Manipal Institute of Technology, Manipal - 576104 (e-mail: raghuprabhu123@yahoo.com).

Rajagopal Chadaga, Additional Professor, Department of Mechanical & Manufacturing Engineering, Manipal Institute of Technology, Manipal - 576104 (e-mail: rchadaga@yahoo.com).

## II. EXPERIMENTAL DETAILS

First, specimens are prepared for the wear, tensile and micro structural analysis. In each case three specimens are prepared for annealing, normalizing, hardening and tempering treatments along with another three specimens for as bought conditions. The average value is considered for the analysis. The shape and dimensions of the specimens for wear and tensile tests are shown in Fig. 2 and Fig. 3.

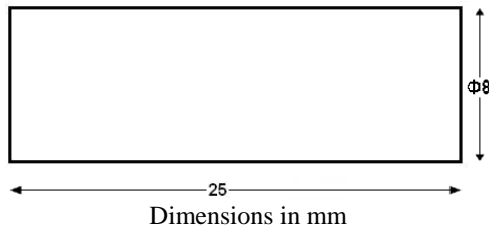

Fig. 2 Wear Test Specimen

Electrical furnace is employed for heating and annealing treatments. For annealing, the set of specimens are heated at  $900^{\circ}\text{C}$  for 30 minutes and cooled to room temperature in the furnace. For normalizing second set of specimens are heated to the same temperature for 30 minutes and cooled in still air under room temperature conditions. For hardening, third and fourth set of specimens are heated to  $900^{\circ}\text{C}$  for 30 minutes and quenched in oil. Out of them, fourth set of hardened specimens are reheated for tempering at  $350^{\circ}\text{C}$  isothermally for 1 hour and cooled slowly.

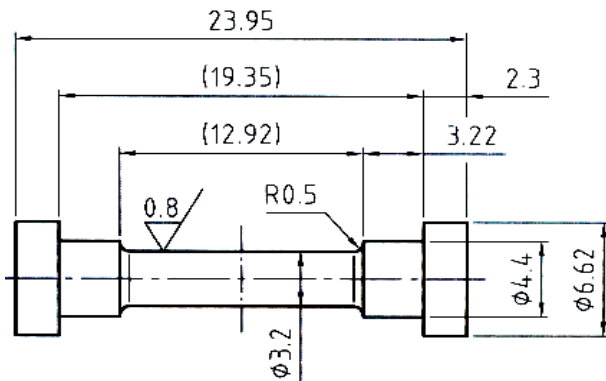

Fig. 3 Tensile Test Specimen

### Tensile Test:

All the tensile specimens are subjected to tensile test in electronic tensometer with 20 KN load cell. Fig. 4 shows the electronic tensometer used for this study.



Fig. 4 Electronic Tensometer Apparatus

### Wear Test:

The dry sliding wear behaviour is analyzed here. Before taking the reading, a trial run of 30 minutes is provided to all specimens to develop flat and smooth contact surface. The experiment is conducted for 1 hour 15 minutes each on all specimens and the weight loss is noted at every 15 minutes run of the specimen. Calculation of the sliding distance in KM is shown below. Fig. 5 shows the photograph of pin-on-disc wear testing machine.



Fig. 5 Wear and Friction Monitor TR – 201CL

$$\text{Sliding speed in m/sec} = \frac{\pi DN}{60,000}$$

Where, D = diameter of wear track in mm (88mm)

T = test duration in seconds

N = rpm of the disc (200)

Sliding distance for T = 15mins is 3.317 KM

### Hardness Test:

All the treated and untreated specimens are subjected to Rockwell hardness test and the hardness numbers are noted. Fig. 6 shows the Rockwell hardness testing machine.



Fig. 6 Rockwell Hardness Testing Machine

*Microstructural Analysis:*

Specimens are polished and etched with NITAL. The metallurgical microscope employed for this analysis is shown in Fig. 7.



Fig. 7 Metallurgical Microscope

III. RESULTS & DISCUSSION

*A. Micro structural Analysis:*

The micro structures of as bought, annealed, normalized, hardened and tempered specimens are shown in Fig. 8, 9, 10, 11, 12 respectively. As bought specimen shows the twisting of ferrite and pearlitic particles due to cold drawing operation. There is no rupturing of grains or no full alignment of grains along the direction of working. This shows the mild deformation of metal. Annealed specimen shows bigger grains of ferrite and pearlitic colonies. More weight percentage of

ferrite is responsible for the decrease in hardness value. Normalized specimen shows finer grains of ferrite, small colonies of pearlite and an increase in pearlitic weight percentage. This is responsible in the increase of ductility of the specimen with moderate increase in hardness value. Tempered specimen shows the relaxation of martensitic structures. The supersaturated martensitic structures ages into lesser c/a ratio BCT martensite and cementite. Microstructure indicates white particles of cementite formed during one hour ageing. Microstructure of hardened specimen shows lath or needle type of martensite particles formed by quenching austenite.



Fig. 8 Microstructure of 'as bought' specimen

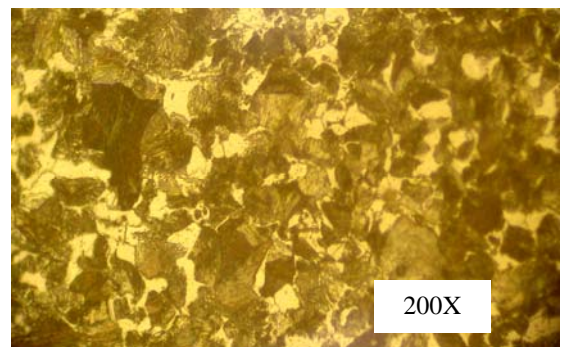

Fig. 9 Microstructure of annealed specimen

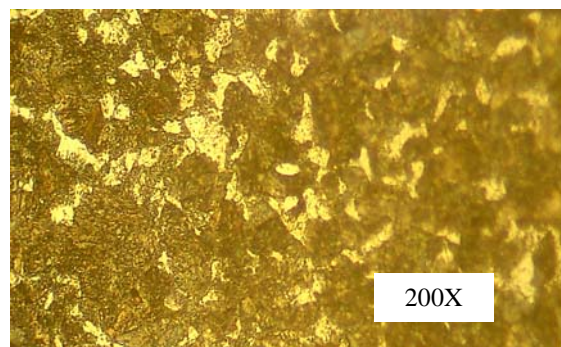

Fig. 10 Microstructure of normalized specimen



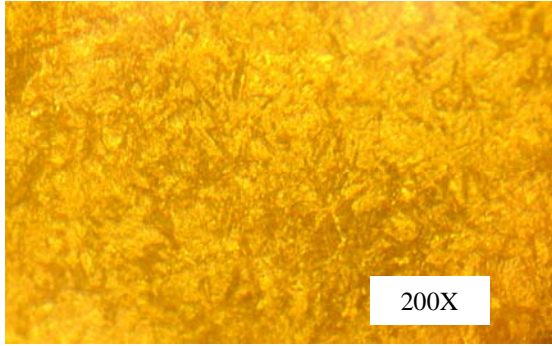

Fig. 11 Microstructure of hardened specimen

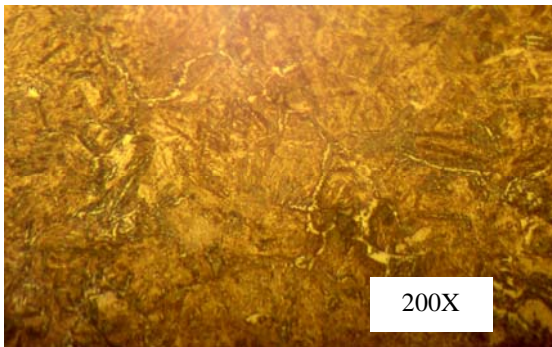

Fig. 12 Microstructure of 'hardened & tempered' specimen

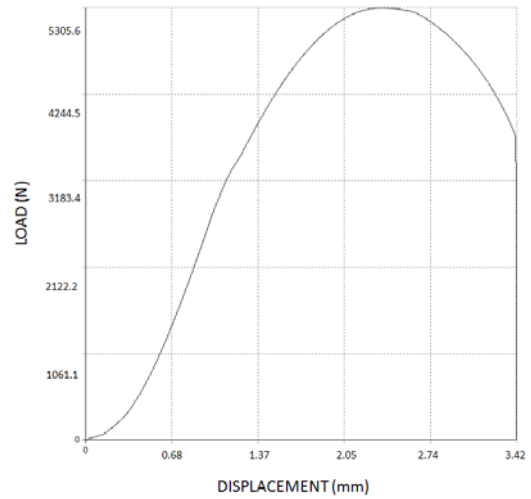

Fig. 13 Load-Displacement Diagram

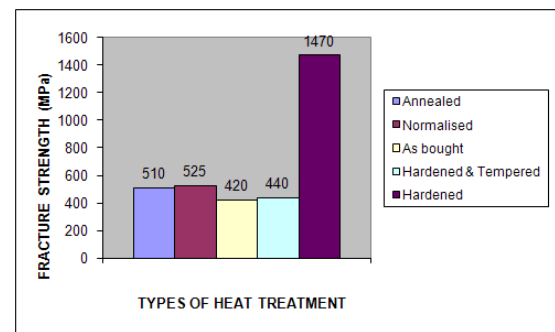
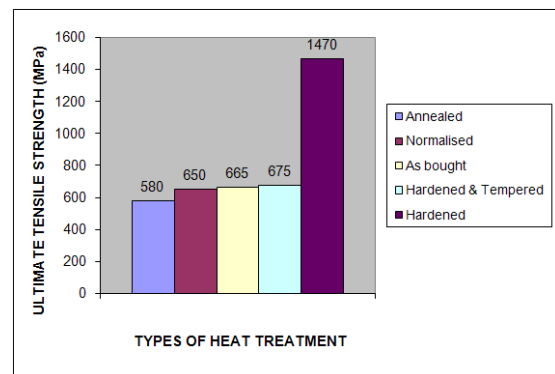
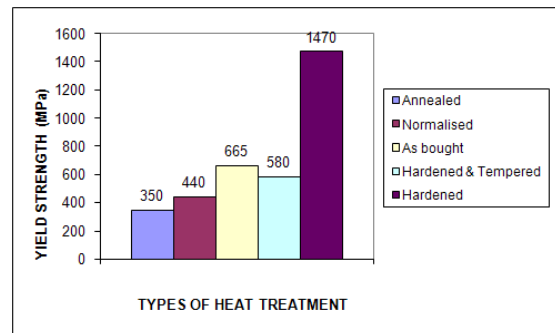

Fig. 14 Variation in strength values w.r.t. different treatments

**B. Tensile Test:**

The load Vs displacement curves are obtained from the electronic tensometer for as bought, annealed, normalized, hardened and tempered conditions. Strength values are calculated using the formula. As bought steel shows partial brittleness and hardened steel shows fully brittle behaviour with identical yield strength, ultimate tensile strength and fatigue strength values. This behaviour also suggests that the as bought metal is cold worked. Surprisingly the normalized specimen shows better ductility compared to annealed specimen. This is due to the formation of more weight percentage of soft pearlitic phases on air cooling. As bought condition shows lesser ductility because of strain hardening. This also supports the agreement that the as bought steel is cold worked. Hardened specimen shows the catastrophic failure of the specimen having almost same break and peak displacement values. Annealed and normalized specimens show a poor ductile (cup and cone type) failure. Fig. 13 shows the load versus displacement graph for annealed specimen. Fig. 14 shows the variation of yield strength, ultimate strength and fracture strength with respect to the type of treatment. Fig. 15 shows the variation of ductility of specimen with respect to the different treatments.

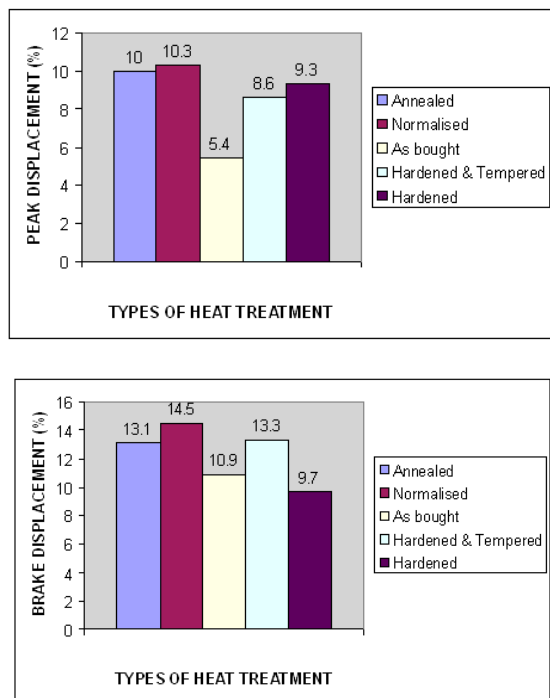

Fig. 15 Variation in ductility values w.r.t. different treatments

### C. Hardness test:

Higher hardness value is observed in hardened specimen and a slight decrease in hardness value is observed after tempering treatment. This is due to the relaxation of supersaturated martensitic structure. As bought steel shows higher hardness compared to normalized and annealed conditions. It indicates that as bought steel is cold worked. Fig. 16 shows the variation of hardness values w.r.t. the type of treatment.

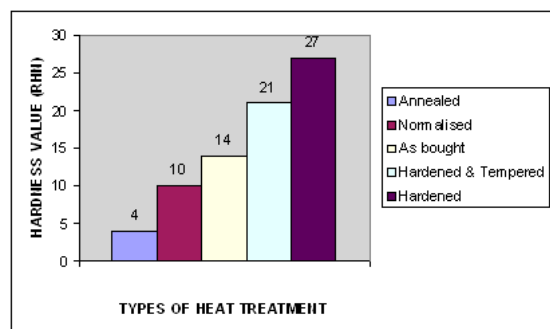

Fig. 16 Variation in Hardness values w.r.t. different heat treatments

### D. Wear test:

The cumulative wear versus sliding distance for heat treated specimens is shown in Fig. 17. Wear is generally the function of hardness. As bought specimen shows a linear gradual wear with respect to sliding distance. This shows the constant resistance of specimen for wear due to previous strain hardening. Hardened specimen shows least wear, that is, it offers highest resistance to wear. It has got higher initial wear,

but the wear rate is very mild upto 7km of sliding distance, later on gradual increase in wear rate is observed.

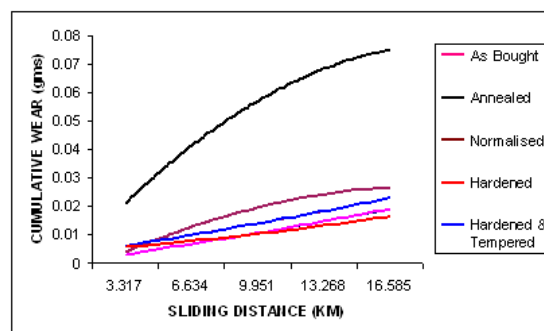

Fig. 17 Cumulative wear rate with respect to sliding distance

This shows the marginal relaxation of martensitic structure because of strain hardening. Since there is decrease in hardness value due to tempering, tempered specimen shows slightly higher wear rate compared to hardened specimen. Wear rate is severe in the case of annealed specimen. This is due to the least hardness value of the specimen. Normalized specimen shows lesser wear rate compared to annealed specimen due to the increase in weight percentage of pearlite and decrease in interlamellar spacing of ferrite and cementite in pearlitic structure. Tempered specimen shows severe increase in wear rate above 17km of sliding distance. This is because of the relaxation of martensitic structure.

## IV. CONCLUSION

- Annealing induces softness.
- Tempering decreases hardness value of the hardened specimen.
- Hardening treatment gives ultimate hardness to the specimen to improve the wear resistance and strength.
- As bought steel hardness value is higher than annealed and normalized conditions, shows lesser ductility and higher tensile strength. It supports the agreement that the steel is cold worked.
- As bought specimen shows a gradual and linear increase in the wear rate.
- Annealed specimen shows a least resist to wear.
- Tempered and as bought specimens shows partial ductile failure in tension.
- Normalized treatment gives ultimate ductility to the specimen.
- Annealed specimen shows the presence of large ferrite and bigger colonies of pearlitic phases.
- Hardened specimen shows the lath or needle type martensitic structure.
- Tempered specimen shows the separation of  $Fe_3C$  during aging of super saturated martensitic structure.

REFERENCES

- [1] Sarwar M, Priestner R., 1996, "Influence of ferrite–martensite microstructural morphology on tensile properties of dual-phase steel", *Journal of Materials Science*, Vol 31, pp 2091–2095.
- [2] Erdogan M, Priestner R., 2002, "Effect of martensite content, its dispersion, and epitaxial ferrite content on Bauschinger behaviour of dual phase steel", *Journal of Materials Science Technology*, Vol 18, pp 369–376.
- [3] Anand Prakash Modi, 2007, "Effects of microstructure and experimental parameters on high stress abrasive wear behaviour of a 0.19 wt % Carbon dual phase steel", *Tribology International Journal*, Vol 40, pp 490-497.
- [4] Chang P., 1984, "Temper-aging of continuously annealed low carbon dual phase steel", *Metal Transformation*, Vol15A, pp 73–86.
- [5] Gunduz S, Demir B, Kacar R., 2008, "Effect of aging temperature and martensite by volume on strain aging behaviour of dual phase steel", *Iron making and Steel making*, Vol 35, pp 63–68.
- [6] Yan-qiu Zia, Wei-min Liu & Qun-Ji Xue, 2005, "Comparative study of the tribological properties of various modified mild steels under boundary lubrication condition", *Journal of Wear*, Vol 38, pp 508-514.
- [7] Anijdan SHM, Vahdani H., 2005, "Room-temperature mechanical properties of dualphase steels deformed at high temperatures", *Materials Letter*, Vol 59, pp 1828–1830.
- [8] Pradeep L Menezes, Kishore, & Satish V Kailas, 2006, "Influence of surface texture on coefficient of friction and transfer layer formation during sliding of pure Mg pin on EN 8 steel plate", *Journal of Wear*, Vol 261, pp 578-591.
- [9] Suleyman gunduz & Atilla Torun, 2008, "Influence of straining and aging on the RT mechanical properties of dual phase steel", *Journal of materials & DSN*, Vol 29, pp 1914-1918.
- [10] Abdalla AJ, Hein LRO, Pereira MS, Hashimoto TM., 1999, "Mechanical behaviour of strain aged dual phase steels", *Materials Science Technology*, Vol 15, pp 1167–70.
- [11] Sun S, Pugh M., 2002, "Properties of thermo mechanically processed dual-phase steels containing fibrous martensite", *Mater Science Engineering A*, Vol 335, pp 298–308.