

An Experimental Investigation on the Effect of Deep cold Rolling Parameters on Surface Roughness and Hardness of AISI 4140 Steel

P. R. Prabhu, S. M. Kulkarni, S. S. Sharma

Abstract—Deep cold rolling (DCR) is a cold working process, which easily produces a smooth and work-hardened surface by plastic deformation of surface irregularities. In the present study, the influence of main deep cold rolling process parameters on the surface roughness and the hardness of AISI 4140 steel were studied by using fractional factorial design of experiments. The assessment of the surface integrity aspects on work material was done, in terms of identifying the predominant factor amongst the selected parameters, their order of significance and setting the levels of the factors for minimizing surface roughness and/or maximizing surface hardness. It was found that the ball diameter, rolling force, initial surface roughness and number of tool passes are the most pronounced parameters, which have great effects on the work piece's surface during the deep cold rolling process. A simple, inexpensive and newly developed DCR tool, with interchangeable collet for using different ball diameters, was used throughout the experimental work presented in this paper.

Keywords—Deep cold rolling, design of experiments, surface hardness, surface roughness

I. INTRODUCTION

THE surface roughness of engineering parts is a significant design specification that is known to have considerable influence on properties such as wear resistance and fatigue strength as stated by Altenberger and Scholtes [1] and El-Axir M. H. et al. [2]. Perfectly flat surface can never be generated. Surfaces have always irregularities in the form of peaks and valleys. Processes by which surfaces are finished differ in its capabilities concerning finishing action, mechanical and thermal damage, residual stresses and materials. These processes are divided according to running in mechanisms into two types: one involves material loss such as grinding and the other depends on plastic squeezing of the surface where by a redistribution on material is performed with no material loss.

The latter is seen in finishing process such as burnishing and deep cold rolling which can be achieved by applying a highly polished and hard ball onto metallic surface under pressure. This will cause the peaks of the metallic surface to

spread out permanently, when the applied pressure exceeds the yield strength of the metallic material to fill the valleys and some form of smoothing takes place. Besides producing a good surface quality, the deep cold rolling process has additional advantages over machining processes, such as securing increased hardness, corrosion resistance and fatigue life as result of the produced compressive residual stress on the surfaces as demonstrated by Tolga Bozdana and Nalla [3].

Shot peening is often been used to increase the safety margin of aerospace components. Compressive residual stresses induced by shot peening have been shown to increase fatigue life by delaying crack initiation or crack propagation. On the other hand, surface roughness and damage produced by shot peening have been reported to promote fatigue crack initiation at shot peened surfaces, leading to lower fatigue life as reported by Kwai S Chan et al. [4]. Advanced techniques such as laser shock peening (LSP), low plasticity burnishing (LPB) and deep cold rolling (DCR) have been shown in recent studies to produce deep penetrating compressive stresses with little or no damage to the peened surfaces. Thus, there is increased interest in utilizing compressive residual stresses as a means to increase fatigue life and enhance component performance. Deep cold rolling is a process in which a ball or roller is pressed against the surface of a work piece by applying a static pressure. The ball is then rolled along the surface to be treated. In contrast to burnishing, which is performed with lower pressures and solely serves to achieve a smooth surface topography, the aim of this treatment is to induce deep residual compressive stresses and work harden surface layers. The surface finish is a critical factor in creating a durable metal component. Manufacturers strive to produce metal surfaces free of scratches, nicks, and gouges, since such defects make components vulnerable to damage. A smooth surface only is insufficient to protect the component against the wear and tear of regular usage. A component's durability is substantially improved when residual compressive stress is produced in the component's surface as reported by Altenberger [5]. In the state of compression, a surface can better withstand the stresses of fatigue and impact. Thus increasing its life span and reducing the need for costly time-consuming replacements. Deep rolling can enhance the high cycle fatigue and low cycle fatigue strength of Ti-6Al-4V. While laser peening also resulted in an improvement in fatigue strength, deep rolling found to be more effective as confirmed by Tolga Bozdana and Nalla [3]. K. H. Kloos et al. [6] found that the increase in fatigue strength is critically affected by the rolling load. The effectiveness of deep rolling is governed by

P. R. Prabhu, Assistant Professor-senior scale, Department of Mechanical & Manufacturing Engineering, Manipal Institute of Technology, Manipal - 576104 (Ph: 0820 2925463; Fax: 0820 2571071; e-mail: raghu.prabhu123@yahoo.com).

S. M. Kulkarni, Professor, Department of Mechanical Engineering, National Institute of Technology Karnataka, Surathkal - 575025, (e-mail: smk@nitk.ac.in).

S. S. Sharma, Professor, Department of Mechanical & Manufacturing Engineering, Manipal Institute of Technology, Manipal - 576104 (e-mail: sharmass_mit@yahoo.co.in).

the cyclic and thermal stability near surface work-hardening rather than macroscopic compressive residual stresses. Since near surface work hardening is known to retard crack initiation, deep rolling is also effective in temperature and stress ranges where macroscopic residual stresses have relaxed almost completely as observed by Juijerm et al. [7]. Although deep cold rolling is restricted to certain geometries, the process is relatively inexpensive, surface finish achieved is good and the chance of fatigue crack propagation is retarded by the compressive residual stresses as reported by Scholtes [8]. For this reason deep cold rolling is increasingly utilized to enhance the fatigue strength and service lives of steel components, such as crankshafts etc. working in the hostile service conditions as given by David K. Matlock et al. [9]. Looking into the literature available it could be realized that a systematic study on identifying the process parameters for effecting DCR is need of the hour.

Thus, in the present work, we examine the effectiveness of deep cold rolling for improving the surface roughness and surface hardness of AISI 4140 steel, which is a commonly used material for the manufacture of automobile parts. This paper also deals with the development of a low cost deep cold rolling tool and process. The aim of this study is to identify the significant of those parameters which influence the surface roughness and/or surface hardness.

II. EXPERIMENTAL DETAILS

A. Workpiece Material

The workpiece material used in this study is AISI 4140 steel. The chemical composition of which is presented in Table 1. The work pieces are received as cylindrical bars of 14mm diameter. The bars are cut to appropriate lengths (140-150mm) and turned to a diameter of 12mm. Using the regular conditions for turning, moderate surface roughness was achieved, similar to that obtained in common manufacturing practices. Initial surface roughness of $4.84\mu\text{m}$ and $7.46\mu\text{m}$ were selected. The surface hardness of those specimens found to be 15C under Rockwell Hardness tester. Fig. 1 represents the details of the specimen used for deep cold rolling.

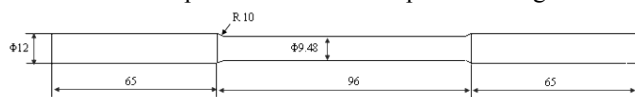

Fig. 1 Workpiece geometry (mm)

TABLE I
 CHEMICAL COMPOSITION OF WORKPIECE MATERIAL (WT.%)

Material	Composition							
	C	Si	Mn	S	Cr	Mo	Ni	Cu
AISI 4140 (EN 19)	0.4	0.27	0.66	0.04	1.2	0.25	0.16	0.12

B. Deep Cold Rolling Tool

A deep cold rolling tool is designed, fabricated and used in the work (see Fig. 2). The tool is mounted on the Kistler Dynamometer (type 9272A) which in turn is mounted on the

tool post of the conventional lathe. Kistler Dynamometer is used for the measurement of forces during deep cold rolling process. The force acting in X direction is taken into consideration as this force is responsible for causing the plastic deformation and hence results in work hardening. DCR process is set on a general purpose conventional lathe machine so as to keep it economical. The tool consists of two parts, a shank and a collet to hold the ball. The ball is free to rotate with the rotation of the workpiece when in contact with the surface of the workpiece during deep rolling process. The ball could be removed easily from the tool for replacement, readjusting, or cleaning by opening the adapter (collet) and lock nut. Two types, High Carbon High Chromium Steel (HCHR) and Tungsten Carbide balls are tried in the current tool. The ball was loaded normal to the surface of a workpiece. As the ball rolls over the component, the pressure from the ball causes plastic deformation to occur on the surface of the material. Since the material develops resistance to deformation, work hardening takes place and a layer of compressive stress develops.

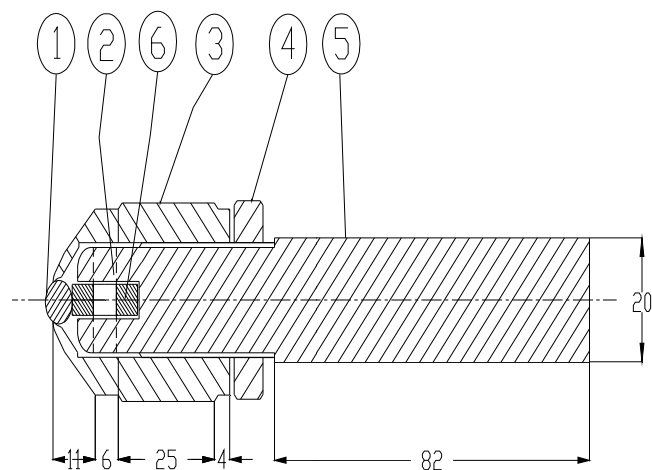

Fig. 2 Deep cold rolling tool. 1 - Ball, 2 - Hardened pin, 3 - Collet, 4 - Locking nut, 5 - Shank, 6 - Bearing

C. Deep Cold Rolling Set-Up

The set-up used in these tests consists of a lathe (PSG type A 141) for the turning and deep cold rolling of the specimens. Figure 3 and 4 shows the complete set-up of deep cold rolling process. A 4-component Kistler Dynamometer (piezoelectric transducer) was clamped on the lathe tool post to measure the forces during treatments. The signal generated by the piezoelectric transducer was first amplified by a charge amplifier and then connected to an A/D converter in the PC. The deep rolling force was determined by the processing using the DynoWare measuring force software.

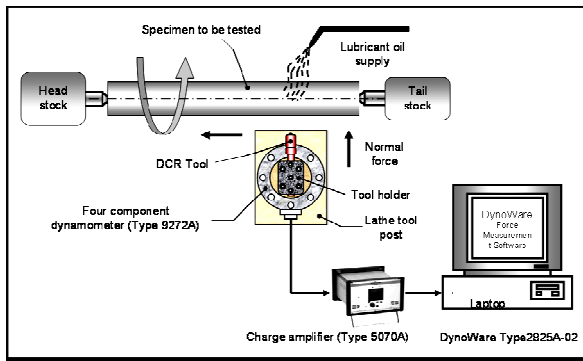

Fig. 3 Deep cold rolling setup



Fig. 4 Experimental set-up of DCR process

III. EXPERIMENTAL DESIGN AND ANALYSIS

A. Screening Experiments

Classical experimental design methods are complex and difficult to use. Additionally large numbers of experiments have to be carried out when number of parameters is large as stated by Luo et al., [10]. In this study, the effect of several parameters on deep cold rolling process is determined efficiently by conducting fractional factorial experiments. Douglas C. Montgomery [11] confirmed that, in screening experiments, generally two levels and large numbers of factors are selected. To study the influence of various process parameters on the surface finish and hardness after deep cold rolling process seven parameters are chosen at 2 levels each as presented in Table 2.

B. Experimental Design

With factors under consideration, the necessary number of runs in the experiment would be $2^7 = 128$. Because each run may require time-consuming and costly setting and resetting of machinery, it is often not feasible to require that many different runs for the experiment. In these conditions, fractional factorials are used that "sacrifice" interaction effects so that main effects may still be computed correctly. Resolution III designs are suitable in situation where large number of parameters need to be considered. Table 3 shows the type III resolution design for the screening significant factors.

TABLE II
FACTORS AND LEVELS OF EXPERIMENTATION

Sl. No.	Factors	Levels	
		1	2
1 (A)	Ball Material	M1	M2
2 (B)	Ball Diameter (mm)	6	10
3 (C)	Feed (mm/min)	9	36
4 (D)	Rolling Force (N)	250	750
5 (E)	Initial Roughness (μm)	4.84	7.46
6 (F)	Lubricant	L1	L2
7 (G)	Number Of Passes	1	3

M1 – High Carbon High Chromium steel ball

M2 – Tungsten Carbide ball

L1 – Brake Oil

L2 – Gear Oil

C. Testing For Hardness & Surface Finish

Rockwell hardness testing machine is used for the hardness tests and a Surtronic Taylor Hobson Talysurf roughness tester for measuring the surface roughness of the treated samples.

IV. RESULTS AND DISCUSSIONS

The surface roughness and surface hardness data are analyzed with the MINITAB 15 software. The table below (Table 3) shows the mean surface roughness (MSR) and mean surface hardness (MSH) values for the different set of experiments.

TABLE III
RESOLUTION III EXPERIMENTAL DESIGN AND MSR, MSH OF AISI 4140 SPECIMEN

Runs	Resolution III design							MSR (μm)	MSH (HRC)
	A	B	C	D	E	F	G		
1	1	1	-1	1	-1	-1	-1	0.392	30.25
2	1	1	1	1	1	1	1	0.47	25
3	-1	1	1	-1	-1	1	-1	0.205	28.5
4	1	-1	1	-1	1	-1	-1	0.27	24.75
5	1	1	-1	1	-1	-1	-1	0.13	24.25
6	-1	-1	-1	1	1	1	-1	0.3	24
7	-1	1	-1	-1	1	-1	1	1.635	26
8	-1	-1	1	1	-1	-1	1	0.232	24.5
9	-1	-1	1	1	-1	-1	1	0.38	26.5
10	-1	1	1	-1	-1	1	-1	0.725	23.25
11	-1	-1	1	1	-1	-1	1	0.37	25.5
12	1	-1	-1	-1	-1	1	1	0.24	22
13	1	1	1	1	1	1	1	0.442	25.75
14	1	1	-1	1	-1	-1	-1	0.515	32.5
15	1	-1	-1	-1	-1	1	1	0.85	20.25
16	-1	1	1	-1	-1	1	-1	1.125	27
17	-1	-1	-1	1	1	1	-1	0.98	20

18	-1	-1	-1	1	1	1	-1	0.4	22.25
19	1	-1	1	-1	1	-1	-1	0.335	24.25
20	1	1	1	1	1	1	1	0.445	26.5
21	-1	1	-1	-1	1	-1	1	0.335	23
22	1	-1	-1	-1	-1	1	1	0.335	27.25
23	1	-1	1	-1	1	-1	-1	0.69	28.25
24	-1	1	-1	-1	1	-1	1	0.88	26.5

*1 – high level, -1 – low level

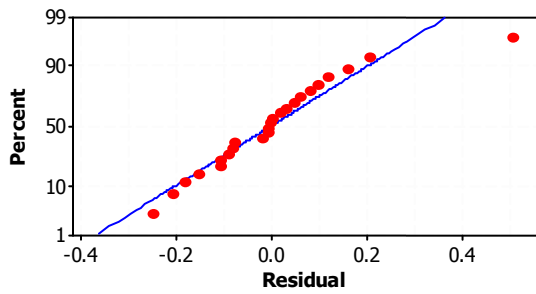

Fig. 5 Normal probability plot for surface roughness

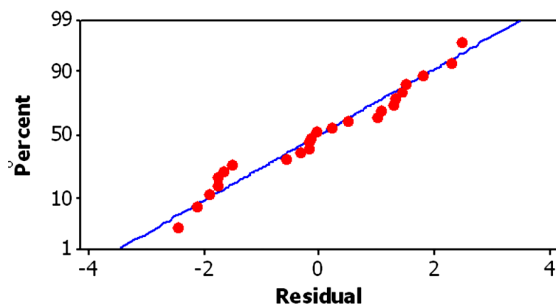

Fig. 6 Normal probability plot for surface hardness

The data are plotted against a theoretical normal distribution in such a way that the points should form an approximate straight line. Departures from this straight line indicate departures from normality. The points on this plot (see Fig. 5 and 6) form a nearly linear pattern, which indicates that the normal distribution is a good model for this data set.

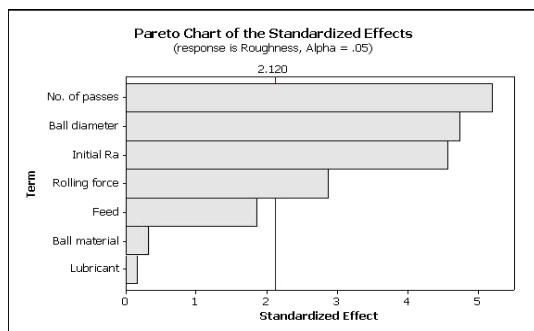

Fig. 7 Pareto chart for surface roughness

TABLE IV
 FACTORIAL FIT: SURFACE ROUGHNESS VS PROCESS PARAMETERS

Term	Effect	Coef	SE Coef	T	P
Ball material	-0.0231	-0.0116	0.03467	-0.33	0.743
Ball diameter	-0.3294	-0.1647	0.03467	-4.75	0.000
Feed	-0.1290	-0.0645	0.03467	-1.86	0.081
Rolling force	0.1990	0.0995	0.03467	2.87	0.011
Initial Ra	0.3177	0.1589	0.03467	4.58	0.000
Lubricant	0.0106	0.0053	0.03467	0.15	0.880
No. of passes	-0.3610	-0.1805	0.03467	-5.21	0.000

P value < 0.05 has significant effect on surface roughness

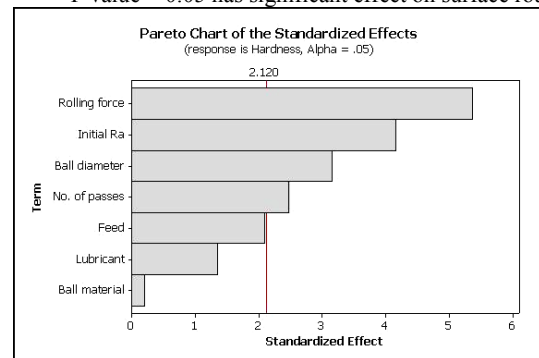

Fig. 8 Pareto chart for surface hardness

TABLE V
 FACTORIAL FIT: SURFACE HARDNESS VS PROCESS PARAMETERS

Term	Effect	Coef	SE Coef	T	P
Ball material	0.125	0.062	0.3102	0.20	0.843
Ball diameter	1.958	0.979	0.3102	3.16	0.006
Feed	-1.292	-0.646	0.3102	-2.08	0.054
Rolling force	3.333	1.667	0.3102	5.37	0.000
Initial Ra	-2.583	-1.292	0.3102	-4.16	0.001
Lubricant	0.833	0.417	0.3102	1.34	0.198
No. of passes	-1.542	-0.771	0.3102	-2.48	0.024

P value < 0.05 has significant effect on surface roughness

Analysis of Variance surface roughness results are shown in Table 4 indicates that four process parameters, ball diameter, rolling force, initial surface roughness and number of tool passes are significant at 95% confidence level. The same can also be seen from the Pareto chart as shown in Fig. 7. ANOVA surface hardness results shown in Table 5 also indicates that the same four parameters ball diameter, rolling force, initial surface roughness and number of tool passes are significant at 95% confidence level. The same is observed from the Pareto chart as shown in Fig. 8.

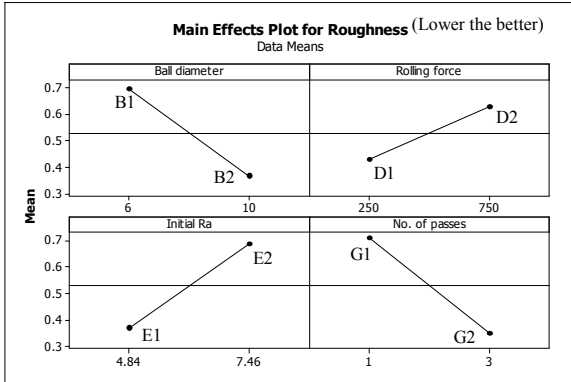

Fig. 9 Main effects plot of surface roughness for the significant factors

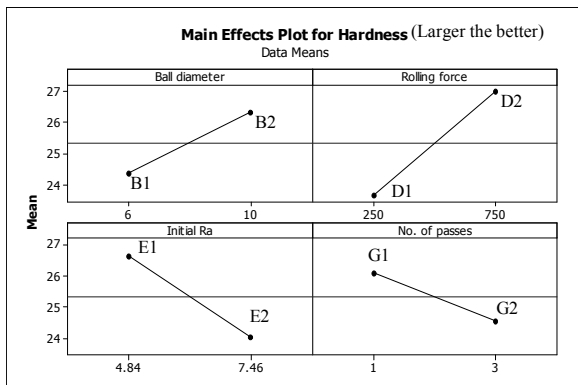

Fig. 10 Main effects plot of surface hardness for the significant factors

3	25.75	26.54	0.79	2.982
4	21.75	22.16	0.41	1.879
5	26.25	25.49	0.76	2.941
6	23.75	23.20	0.55	2.334
7	23.12	22.58	0.54	2.398
8	29.25	30.04	0.79	2.635

The regression equation for Surface Hardness = {25.6889 + 0.489583 x Ball diameter + 0.00666667 x Rolling force - 0.986005 x Initial Ra of work piece - 0.770833 x No. of passes} HRC

The main effects plot in Figure 9 indicate that surface roughness improves with increase in ball diameter and increase in number of tool passes whereas surface roughness decreases with increase in rolling force and higher initial roughness of the workpiece. The main effects plot in Figure 10 indicate that surface hardness increases with increase in rolling force and increase in ball diameter whereas decreases with increase in higher initial roughness of the workpiece and increase in number of tool passes.

It is observed from Table VI and Table VII that fit (predicted) value is quite close to the experimental observation. The predicted deep cold rolling performance was compared with the actual deep cold rolling performance and a good agreement was obtained between these performances. The error between the experimental results and the predicted values for surface roughness and surface hardness lie within 11.96 to 0.94% and 2.98 to 1.87% respectively.

V. CONCLUSIONS

Based on the above observations the following conclusions may be drawn.

- √ It is observed from the ANOVA table and main effects graphs that rolling force, ball diameter, initial roughness of the work piece, number of tool passes have a significant effect on the responses in DCR process.
- √ Using DCR process surface hardness has been increased from 15C to 29C.
- √ The rolling force play an important role in enhancing the hardness of the treated specimens which in turn will have an influence in improving the fatigue life of the component. Higher the surface hardness higher will be the residual compressive stress, and thus higher the fatigue life of the component.
- √ It is also seen that the surface roughness decreases with increase in ball diameter and number of tool passes and increases with increase in rolling force and initial roughness of the workpiece.
- √ It is observed that the surface hardness increases with increase in ball diameter and rolling force and decreases with increase in initial roughness of the workpiece and number of tool passes.
- √ From the experiments it is also inferred that ball material, feed and lubricant have very less influence on the response in DCR process.

TABLE VI
REGRESSION DATA SHOWING ACTUAL, FIT AND RESIDUAL VALUES FOR SURFACE ROUGHNESS

Runs	MSR (μm)	Fit	Residual	% Error
1	0.292	0.285	0.007	2.2948
2	0.388	0.441	0.053	11.960
3	0.457	0.453	0.004	0.9421
4	0.915	0.933	0.018	1.9316
5	1.002	1.131	0.129	11.438
6	0.283	0.254	0.029	11.593
7	0.27	0.242	0.028	11.291
8	0.453	0.484	0.031	6.4233

The regression equation for Surface Roughness = {0.603505 - 0.0823438 x Ball diameter + 0.000397917 x Rolling force + 0.121263 x Initial Ra of work piece - 0.180521 x No. of passes} μm

TABLE VII
REGRESSION DATA SHOWING ACTUAL, FIT AND RESIDUAL VALUES FOR SURFACE HARDNESS

Runs	MSH (HRC)	Fit	Residual	% Error
1	27.5	26.71	0.79	2.964
2	26.5	25.91	0.59	2.250

√ It is also observed that the predicted surface roughness & hardness value is quite close to the experimental observation.

REFERENCES

- [1]. I. Altenberger, B. Scholtes, "Improvement of fatigue lifetime of mechanically surface treated materials in the low cycle fatigue regime", Surface Treatment IV (Eds. Kenny J., Brebbia S.). Southampton, WIT press, p. 281, 1999.
- [2]. M. H. El-Axir, O. M. Othman, A. M. Abodiena, "Improvements in out-of-roundness and microhardness of inner surfaces by internal ball burnishing process", Journal of Materials Processing Technology, Vol 196, pp 120-128, 2008.
- [3]. A. Tolga Bozdana, R. K. Nalla, "On the influence of mechanical surface treatments (deep rolling and laser shock peening) on the fatigue behaviour of Ti-6Al-4V at ambient and elevated temperatures", Materials Science and Engineering A355, pp 216-230, 2003.
- [4]. Kwai S. Chan, Michael P. Enright, Jonathan P. Moody, Patrick J. Golden, Ramesh Chandra, Alan C. Pentz, "Residual stress profiles for mitigating fretting fatigue in gas turbine engine disks", International Journal of Fatigue, Vol. 32, pp 815-823, 2010.
- [5]. I. Altenberger, "Deep rolling - the past, the present and the future", 9th International conference on shot peening. September 6-9, Paris, Marne la Vallee, France, 2005.
- [6]. K. H. Kloos, B. Fuchsbaauer, J. Adelman, "Fatigue properties of specimens similar to components deep rolled under optimized conditions", International journal of fatigue 9, No. 1, pp 35-42, 1987.
- [7]. P. Juijerm, U. Noster, I. Altenberger, B. Scholtes, "Fatigue of deep rolled AlMg4.5Mn (AA5083) in the temperature range 20-3000C", Materials Science and Engineering A 379, pp 286-292, 2004.
- [8]. B. Scholtes, "Assessment of residual stresses, Structural and residual stress analysis by non-destructive methods", V. Hauk, Ed., Elsevier, Amsterdam, pp 590-632, 1997.
- [9]. David K. Matlock, Khaled A. Alogab, Mark D. Richards, John G. Speer, "Surface Processing to Improve the Fatigue Resistance of Advanced Bar Steels for Automotive Applications", Materials Research, Vol. 8, No. 4, pp 453-459, 2005.
- [10]. H. Luo, J. Liu, L. Wang, Q. Zhong, "The effect of burnishing parameters on burnishing force and surface micro hardness", International Journal of Advanced Manufacturing Technology, Vol 28, pp 707-713, 2006.
- [11]. Douglas C. Montgomery, "Design and Analysis of Experiments", sixth edition, John Wiley & sons, Inc., 2005.

P. R. Prabhu received his Bachelor's Degree in Mechanical Engineering (Mangalore University, India 2001) and Master's Degree in Engineering Management (MAHE University, India 2003). He has to his credit 15 months of professional experience in industry and more than six years in teaching and research. His area of interest includes Manufacturing, Metallurgy, Design of Experiments for Mechanical Engineering Problems. He is a faculty member at Manipal Institute of Technology, Manipal and carrying his research in the area of manufacturing from Manipal University.

S. M. Kulkarni holds Bachelor's degree in Mechanical Engineering (Mysore University, India 1985), Master's degree in engineering design (Bharathiar University, India 1989) and PhD degree in Composite materials (Indian Institute of Science, Bangalore, India 2002). He has 20 years of teaching experience. His area of interest includes Materials, Composite and Smart Materials, Rapid Manufacture, Product Design, Mechatronics, Sensors and Actuators, MEMS and Design of Experiments for Mechanical Engineering Problems. He has received Sir Vithal N. Chandavarkar Medal for best PhD thesis in Engineering Faculty, Indian Institute of Science, 2002. He has published more than 24 research papers in journals and presented 35 research papers in conferences.

S. S. Sharma holds Bachelor's degree in Industrial & Production Engineering (Mysore University, India 1987), Master's degree in Materials Engineering (Mangalore University, India 1996) and PhD degree in Materials Engineering (Manipal University, India 2007). He has 24 years of teaching experience. His area of interest includes Heat Treatment, Deformation of Metals, Material Characterization, Composite Materials. He has published 01 research papers in journals and presented 12 research papers in conferences.