

Combustion, Emission and Performance Characteristics of a Light Duty Diesel Engine Fuelled with Methanol Diesel Blends

Mishra Chinmaya, Pal Anuj, Tomar Vishvendra Singh, and Kumar Naveen

Abstract—Combustion, emission and performance characterization of a single cylinder diesel engine using methanol diesel blends was carried out. The blends were 5% (v/v) methanol in diesel (MD05) and 10% (v/v) methanol in diesel (MD10). The problem of solubility of methanol and diesel was addressed by an agitator placed inside the fuel tank to prevent phase separation. The results indicated that total combustion duration was reduced by 15.8% for MD05 and 31.27% for MD10 compared to the baseline data. Ignition delay was increased with increasing methanol volume fraction in the test fuel. Total cyclic heat release was reduced by 1.5% for MD05 and 6.7% for MD10 as compared to diesel baseline. Emissions of carbon monoxide, hydrocarbons along with smoke were reduced and that of nitrogen oxides were increased with rising methanol contents in the test fuel. Full load brake thermal efficiency was marginally reduced with increased methanol composition in the blend.

Keywords—Combustion, diesel engine, emission, methanol, performance.

I. INTRODUCTION

INCREASING rate of crude oil production, decline in reserve to production ratio of fossil fuels, fluctuating crude oil prices, rising trend of pollutant emissions and the consequent environmental degradation are some of the serious issues looming over the modern petroleum derived global economy. A major proportion of petroleum derived oils are used as transportation fuel in diesel engines and this usage is alarmingly increasing over the years. In this context, development of new and alternative engine fuels of renewable nature and potential to reduce emissions are beneficial to address both the sustainability and environmental aspects of “increased mineral diesel consumption” [1]. Amongst various alternative fuels, methanol seems to be a promising option. It can be produced from anything that can be converted into

C. Mishra is a postgraduate student and member of Center for Advanced Studies and Research in Automotive Engineering, Delhi Technological University, Delhi-110042, India (Mobile-+918010396780; e-mail: chinmaya.pravatmishra@gmail.com).

A. Pal is an undergraduate student of Automobile Engineering at Delhi Technological University, Delhi-110042, India (e-mail: anujpaldce@gmail.com).

V.S Tomar is an undergraduate student of Mechanical Engineering at Delhi Technological University, Delhi-110042, India (e-mail: vst.dtu@gmail.com).

N. Kumar is Professor, Mechanical Engineering Department, Delhi Technological University and Head, Center for Advanced Studies and Research in Automotive Engineering, Delhi-110042, India (e-mail: naveenkumardce@gmail.com).

carbon monoxide and hydrogen on partial combustion [2], [3]. So a wide range of non-petroleum carbon based feed stocks like coal, natural gas, biomass, wood, agricultural residues and municipal wastes etc. can be exploited as source of methanol production [2]-[4]. Besides, the ambitious carbon capture and sequestration units based on industrial chimney stack may be used as an excellent source of methanol. Production of methanol is simple and less energy consuming. Partial combustion of raw material is carried out first to generate synthesis gas (CO+H₂) which when passed over catalysts (Cu-Zn-Cr) results in methanol production [5]. Therefore, methanol can be termed as a renewable alternative fuel in true sense.

Methanol has been long considered as a better spark ignition engine fuel compared to gasoline due to its high octane rating, high laminar flame propagation speed, higher chemically correct fuel-air ratio and oxygen rich composition [6]-[9]. However, its application in diesel engines brings a set of opportunities and challenges. Various physico-chemical properties of mineral diesel and methanol are described in Table I.

TABLE I
PROPERTIES OF DIESEL AND METHANOL [3],[6],[7],[9],[10],[11]

Sl No	Properties	Methanol	Diesel
1	Formula	CH ₃ OH	C ₁₂ H ₂₆ -C ₁₄ H ₃₀
2	Molecular weight (g/mol)	32	170-198
*3	Density (g/cm ³ , at 20°C)	0.79	0.824
4	Boiling temperature (°C)	64.7	190-280
*5	Flash point (°C)	11	78
6	Auto-ignition temperature (°C)	470	300-340
*7	Viscosity (cSt s at 298.15° K)	0.684	3.12
8	Stoichiometric fuel-air ratio	0.154	0.069
9	Cetane number	3-5	55
*10	Lower heating value (MJ/kg)	21.96	46.83
11	Heat of vaporization (MJ/kg)	1.11	0.27
12	Sulfur content (ppm)	0	<50

*Properties 3, 5, 7 and 10 are evaluated at laboratory and validated.

Lighter molecular weight, lower viscosity and lower density of methanol compared to mineral diesel indicate superior

injection and vaporization properties. Higher stoichiometric fuel-air ratio and hydrogen to carbon ratio of methanol as compared to diesel may be beneficial to reduce soot and smoke [3]. Methanol has nearly 4 times higher latent heat of vaporization than diesel which may be helpful in checking in-cylinder temperature by its quenching effect [12]. On the other hand, methanol possesses less than half the heating value of diesel. Therefore, more quantity of methanol is required than diesel to generate same amount of power. The most intriguing challenge associated with methanol for diesel engine application is its extremely low cetane number and higher auto-ignition temperature as shown in Table I. These properties increase the ignition delay and exhibit poor combustion characteristics. The inferior ignition behavior of methanol makes it incompatible with diesel engine for direct application. However, blending of methanol in diesel in appropriate proportions may provide a tradeoff between poor ignition behavior and reduction in emission as an oxygenated alternative fuel. The lack of solubility of methanol in diesel is another area of concern. Looking at the opportunities methanol offers as an alternative fuel, a series of serious research has been carried out to address the issues of poor combustion behavior, lack of solubility in diesel etc. A brief review of existing literature regarding application of methanol in diesel engines is discussed below.

Bayraktar [3] prepared stable methanol diesel blend with 1% dodecanol as the solvent. Methanol composition was varied from 2.5% to 15% with stepwise increment of 2.5%. Results from the subsequent application on a single cylinder diesel engine at various compression ratios indicated best performance parameters for MD10 at higher compression ratios. *Sayin, Ozsezen and Canakci* [11] carried out performance and emission characterization of a DI diesel engine using methanol (5%, 10% and 15%) blended diesel fuel at various injection pressures and timings. The results indicated reductions in BTE and emissions of CO and THC where as BSFC and NO_x emission was increased with increased methanol contents in the test fuel. Best engine performance results were obtained at rated injection pressure and timing. However, increasing injection pressure and timing resulted in reduced smoke, CO and THC emissions and increased NO_x emission. Phase separation issue was addressed by a mixer inside the fuel tank. *Huang et.al.* [13] prepared a stabilized diesel methanol blend using oleic acid and isobutanol as solvents. The results showed that increased volume fraction of methanol in diesel/methanol blend increased the heat release rate in the premixed burning phase and shortened the combustion duration of diffused burning phase. Ignition delay was found to increase with methanol volume fraction and advancement in injection timing. Maximum cylinder pressure increased with increase in methanol volume fraction and advancement in injection timing. Maximum mean gas temperature showed a marginal increase for blended fuels as compared to baseline. *Sayin* [14] carried out a comparative performance and emission assessment of diesel engine fueled with diesel-methanol and

diesel-ethanol blends. 1% by volume of dodecanol was used to prepare homogeneous diesel-methanol blends (M5 and M10). The results showed that BSFC and emissions of NO_x increased while BTE, smoke opacity, emissions of CO and THC decreased with methanol-diesel and ethanol-diesel fuel blends. *Chao, Lin, Chao, Chang, Chen* [15] used methanol-containing additive (75% methanol with ignition and lubricity improvers) termed as MCA and prepared five fuel samples (0, 5, 8, 10 and 15% of MCA by volume in diesel) for diesel engine application. Results showed that MCA addition slightly decreased particulate emissions but generally increased both THC and CO emissions. Decrease in NO_x emissions was found common in all MCA blends. *Cheng, Cheung, Chan, Lee, Yao* [16] carried out experiments on a four cylinder DI engine using fumigated methanol. Fumigation was carried out by injecting methanol to top up 10%, 20% and 30% of the power output. Results indicated reduction in BTE with increase in fumigation amount of methanol. Smoke opacity and particulate matter emission was reduced where as emission of CO, THC and NO_x was increased with fumigation. *Zhang, Cheung, Chan, Yao* [17] investigated the combined effect of methanol fumigation and diesel oxidation catalyst on a four cylinder diesel engine performance and emissions. Results indicated reduction in BTE at part loads and a marginal increase in BTE at full load with increased fumigation. Combined use of fumigation methanol and diesel oxidation catalyst led to a reduction of THC, CO, NO_x, particulate mass and particulate number concentrations at medium to high engine loads. *Yao et.al.* [18] introduced diesel/methanol compound combustion (DMCC) system consisting of diffusion combustion with diesel fuel and premixed combustion of air/methanol mixture ignited by diesel. The results indicated reduction in NO_x and soot simultaneously, however, emissions of THC and CO increased as compared to baseline data of diesel. However, use of oxidation catalyst was helpful in reducing all emissions in DMCC mode. Apart from fumigation, compound combustion, agitation and use of solvent methods were used for methanol usage in diesel engines. Some researchers also explored the possibility of methanol diesel emulsions [19] and the blend of methanol-biodiesel-ethanol with mineral diesel as possible fuel combinations [6], [20]-[22].

Most of the research indicated that methanol composition should be confined to less than 20% in the blend of methanol and diesel for good results. Phase separation issues were addressed by agitation, emulsion, use of solvents or methanol containing additives etc. for application of methanol at lower percentage. However, in order to use methanol at higher percentage, fumigation and compound combustion modes were suggested with substantial engine hardware modification. Emissions of CO and THC from the later type of arrangements were found to increase compared to baseline.

Therefore, it was concluded that a comprehensive combustion, emission and performance characterization of a single cylinder unmodified diesel engine fuelled with blends of methanol and diesel at lower proportions (5% and 10%)

may be studied to explore application of methanol in diesel engines. The phase separation issue was addressed by putting a mechanical agitator driven by a small electric motor inside the fuel tank such that uniformity in the fuel was maintained and formation of cavitations avoided.

II. MATERIALS AND METHODOLOGY

A. Test Fuels

The mineral diesel utilized in the experiment was procured from a local dealer. Analytical grade anhydrous methanol with 99.7% purity was taken for the proposed study. Three test fuel samples were taken for the present study; neat diesel, 5% methanol in 95% diesel, 10% methanol in 90% diesel and were named as Baseline, MD05 and MD10 respectively. Some

of the physico-chemical properties of the test fuel samples were evaluated in the laboratory and summarized in Table II.

B. Experimental Set Up

Fig. 1 shows the line diagram of experimental set up. The test engine used for the experiment was a “Kirloskar” make single cylinder, vertical, four strokes, water cooled, naturally aspirated, direct injection diesel engine with a bowl shaped piston surface geometry. The engine shaft was coupled with an eddy current type dynamometer to load the engine. The specification of the engine is provided in Table III.

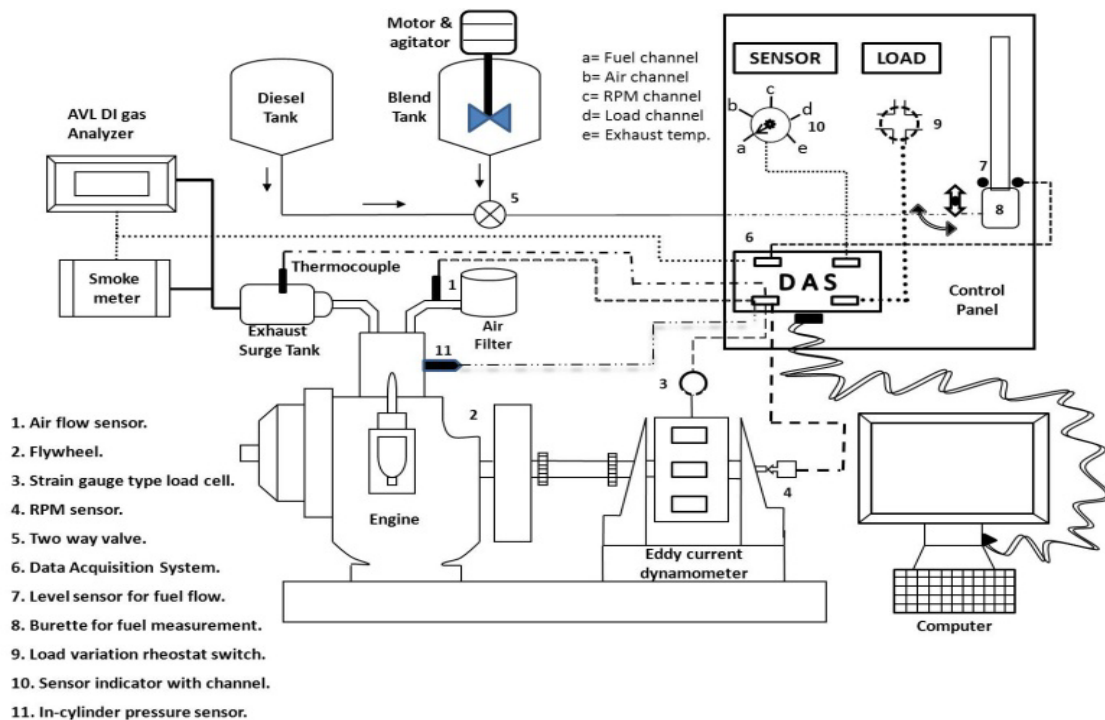

Fig. 1 Engine test rig lay out

Two sets of fuel tanks were provided for the engine set up. One tank was used for diesel and the other tank was meant for methanol diesel blend. The second tank was mounted with a small agitator to avoid phase separation between diesel and methanol. With a little trial and error it was found that the agitator at 150rpm fulfilled the objective of homogeneous blend and absence of cavitations in the fuel line. The fuel line connecting the blend tank and engine was shortened to avoid phase separation within it. The arrangement provided satisfactory homogeneous blend of methanol and diesel for engine trial.

TABLE II
 PROPERTIES OF TEST FUELS

SI No	Properties	ASTM Standard s	Diese l	MD0 5	MD10
1	Density (g/cm ³ , at 20°C)	D792-08	0.824	0.823	0.82
2	Flash point (°C)	D92-12	78	71	64
3	Viscosity (mPasat 298 K)	D445-12	3.12	3.01	2.91
4	Heating value (MJ/kg)	D240-09	46.83	44.40	42.81
5	Oxygen content (wt. %)	--	0	2.5	5

TABLE III
 ENGINE SPECIFICATION

No. of cylinder	1
Strokes	4
Power	5.2kW@1500rpm
Cylinder diameter	87.5mm
Stroke length	110mm
Compression ratio	17.5:1
Orifice diameter	20mm
Dynamometer arm length	185mm
Fuel injection timing	23°BTDC

The cyclic variation of combustion pressure and the corresponding crank angle was recorded using a “Kubeler” piezoelectric water cooled transducer, with a low noise cable, mounted into the engine head. The pressure transmitter contained a piezoelectric sensor and charge amplifier. A very accurate strain gauge type load cell was attached to the dynamometer shaft for measuring the load. The temperature sensors employed are K-Type thermocouples. Air flow rate was measured using a mass airflow sensor. Fuel consumption rate was measured by 20cc burette and stop watch with level sensors. Fuel flow rate, air flow rate, load, pressure crank angle history and temperature data were fed to a data acquisition system NI USB-6210, 16-bit. A personal computer with a software package “Engine soft” was connected to the data acquisition system for online and subsequent offline analysis. The engine emissions and smoke opacity was measured using “AVL Di” gas analyzer and “AVL 437” smoke meter respectively. All the instruments used for the experiment were of standard quality with tolerable % uncertainty. The reproducibility of the results were checked and found acceptable. Table IV shows the accuracies of measurements and uncertainties of the calculated results.

TABLE IV
 ACCURACIES AND UNCERTAINTIES OF RESULTS

Measurements	Accuracy
Engine load	±0.1Kg
Speed	±20 rpm
Time	±0.5%
Temperature	±1°C
Carbon monoxide	±0.02%
Total hydrocarbons	±2 ppm
Oxides of nitrogen	±15ppm
Smoke	± 2%
Calculated results	Uncertainty
Engine power	±1%
Fuel consumption	±2%
Crank angle encoder	±0.5°CA

C. Test Procedure

The compression ignition engine was started using neat diesel. The engine was warmed up till the jacket water temperature stabilized at 60°C. When the engine was ready, all the parameters like volumetric air and fuel flow rate, emissions of CO, THC, NO_x and opacity were taken. Now the load on the engine shaft was increased by enhancing the current flow inside the eddy current type dynamometer using a rheostat switch. Various loads applied to the engine were 0%, 20%, 40%, 60%, 80% and 100% of the rated load. All performance and emission parameters were noted at each load and 1500 rpm speed. However, for simplicity and more conclusive results, the performance and emission parameters were averaged corresponding to lower loads, medium loads and higher loads. Lower loads indicated the average values of parameters corresponding to 0% and 20% loads. Similarly Medium loads indicated average values of parameters corresponding to 40% and 60% loads and higher loads indicated average values of parameters corresponding to 80% and 100% loads. At full load mean of 20 cycles of pressure crank angle data was collected for combustion analysis. The data so obtained were treated as the diesel baseline. Now the fuel tank was swapped using a two way valve and the methanol diesel blend was fed to the engine. All the above test parameters were determined subsequently for MD05 and then MD10 test fuels separately. The reproducibility of results were checked and found satisfactory.

D. Heat Release Characterization

Evaluation of cyclic heat release is very much significant for combustion study. Various heat release models have been developed by researchers for determining critical combustion parameters like heat release rate, pressure rise rate etc. In the present study Sorenson’s [23] zero dimensional heat release model was used for heat release characterization. It is a thermodynamic model based upon energy conservation principle. Neglecting the heat loss through piston rings [24] the energy balance inside the engine may be written as;

$$\frac{dQc}{d\theta} - \frac{dQw}{d\theta} = \frac{d(mu)}{d\theta} + P \frac{dV}{d\theta} = mC_v \frac{dT}{d\theta} + P \frac{dV}{d\theta} \quad (1)$$

Now the universal gas equation is given by

$$PV = mRT \quad (2)$$

The derivative of universal gas equation with respect to crank angle is given by

$$P \frac{dV}{d\theta} + V \frac{dP}{d\theta} = mR \frac{dT}{d\theta} \quad (3)$$

Putting (3) in (1), the heat release rate is derived as follows.

$$\frac{dQc}{d\theta} = P \frac{C_p}{R} \frac{dV}{d\theta} + V \frac{C_v}{R} \frac{dP}{d\theta} + mT \frac{dC_v}{d\theta} + \frac{dQw}{d\theta} \quad (4)$$

(4) is further simplified for actual heat release calculation and is given below.

$$\frac{dQc}{d\theta} = \frac{1}{\gamma-1} V \frac{dP}{d\theta} + \frac{\gamma}{\gamma-1} P \frac{dV}{d\theta} + \frac{dQw}{d\theta} \quad (5)$$

where

$$\frac{dQw}{d\theta} = h.A (T_w - T_j) \quad (6)$$

The heat transfer coefficient “h” was evaluated by using the correlation formula given by Woschni [25]. C_p and C_v are temperature dependent parameters whose formulae are same as mentioned in reference [25]. The primary data used for heat release calculation was the pressure crank angle data obtained during experiment. (5) was used for the determination of heat release rate. Pressure rise rate and cumulative heat release was calculated by standard mathematical operations in the HRR spread sheet database.

III. RESULTS

Various primary engine trial data obtained during the experiment were fed to a comprehensive spreadsheet database using “MS-EXCEL”. The combustion, emission and performance results were obtained by carrying out requisite mathematical operations in the master spreadsheet. Subsequently the characteristics curves were plotted using the spreadsheet database. Combustion results included pressure-crank angle diagram, HRR, cumulative heat release and pressure rise rate etc. Emissions results included that of CO, HC, NO_x, smoke and exhaust temperature etc. In the end performance results like BTE, BSFC, BSEC etc. were evaluated and the consequent characteristic curves were plotted. The results are described as under.

A. Combustion

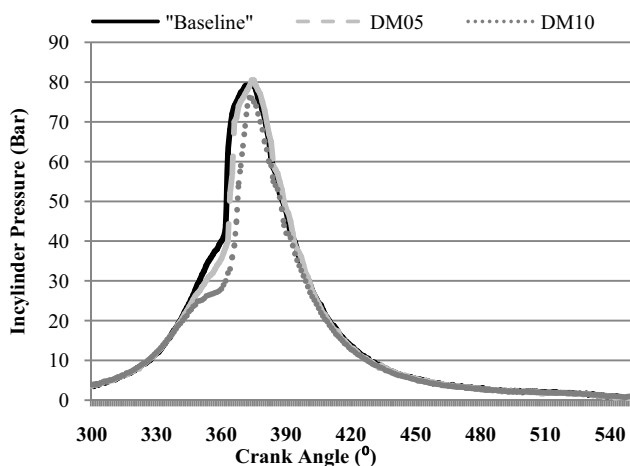

Fig. 2 Pressure-crank angle diagram for test fuels

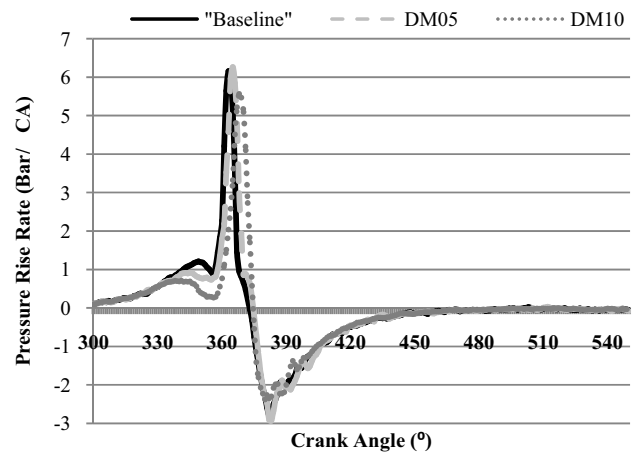

Fig. 3 Pressure rise rate diagram for test fuels

Fig. 2 shows the pressure-crank angle diagram and Fig. 3 shows pressure rise rate to crank angle diagram for various test fuels. It is evident that MD05 exhibited higher in-cylinder pressure as compared to diesel baseline. MD10, on the other hand, showed higher pressure rise rate than baseline, but in-cylinder pressure was more or less equal to the baseline data.

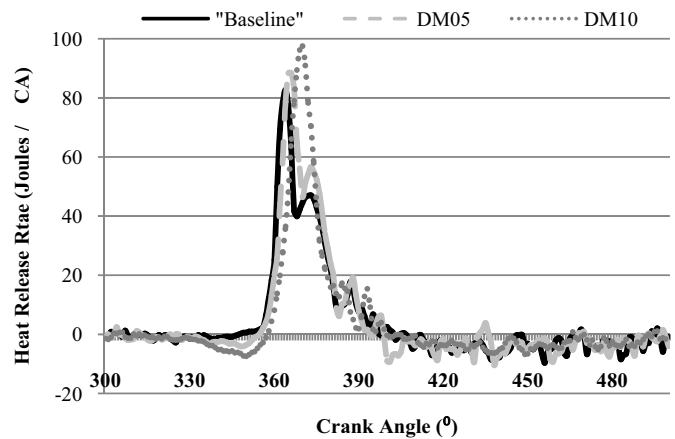

Fig. 4 Heat release rate diagram for test fuels

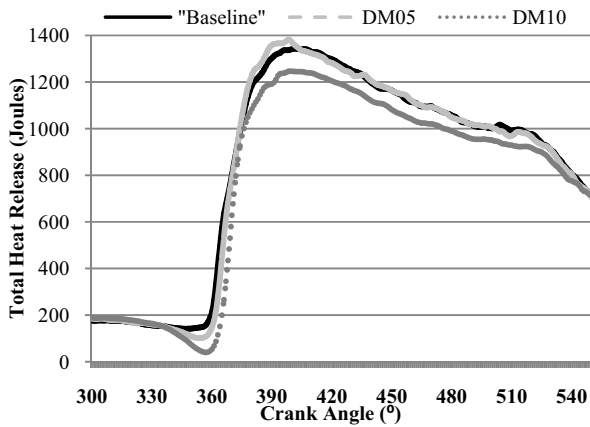

Fig. 5 Cumulative heat release for test fuels

Fig. 4 shows heat release rate (HRR) per crank angle and Fig. 5 shows cumulative heat release for various test fuels. It can be observed that the curve of HRR shifts towards right with increase in volume fraction of methanol in the test fuel which indicates ignition delay. Ignition delay was calculated from the heat release rate curve as the difference between the crank angle corresponding to fuel injection and the crank angle at which positive heat release occurred. Due to ignition delay and higher rate of pressure rise, blended fuels showed higher maximum heat release per crank angle than diesel baseline. Another notable observation showed that the crank angle corresponding to maximum heat release rate shifted rightwards compared to baseline data. Therefore, in-cylinder temperature of blended fuels was inferred to be higher than baseline data and shifted towards advanced crank angles. Total cyclic heat release was found to decrease with increase in methanol volume fraction in the test fuel. It was also observed that the premixed and diffusion phases remained distinctly visible in the HRR diagram for all the test fuels. However, the percentage of heat release in premixed phase compared to the total cyclic heat release was increased with increase in methanol composition.

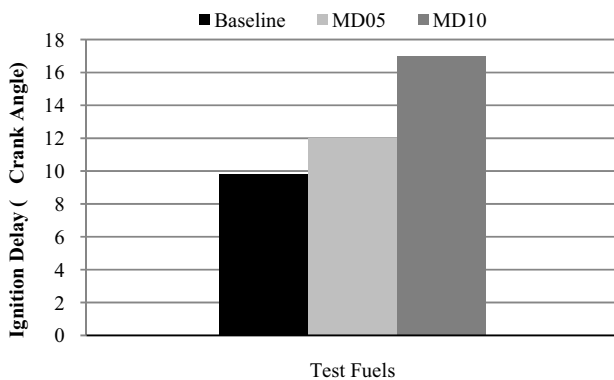

Fig. 6 Ignition delay in °CA

The diffusion phase duration and heat release was continuously reduced with increase in methanol composition. A summary of combustion behavior obtained from the results is shown in the following figures.

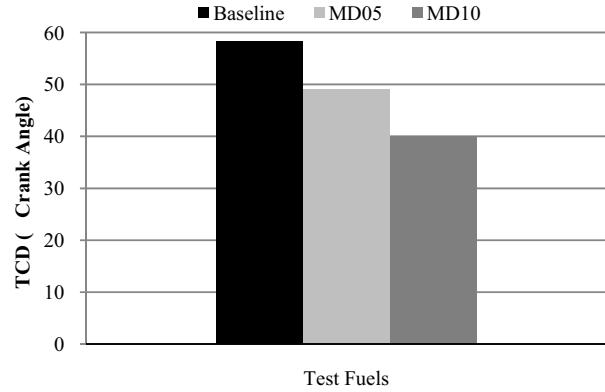

Fig. 7 Total combustion duration in °CA

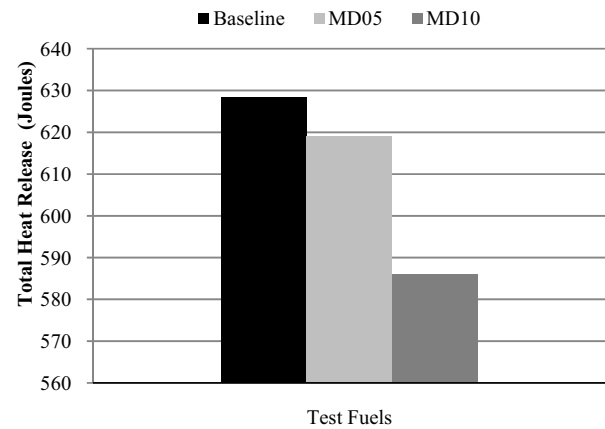

Fig. 8 Total cyclic heat release in Joules

Fig. 6 shows the ignition delay for various test fuels. MD05 showed 12° crank angles ignition delay and that of MD10 showed 17° crank angles as compared to 9.8° exhibited by diesel baseline. The rise in ignition delay with increased volume fraction of methanol in the test fuel was due to the poor cetane rating and very high heat of vaporization of methanol as discussed earlier. Due to higher ignition delay, injected fuel gets accumulated inside the combustion chamber for a while and when ignition starts higher amount of accumulated fuel suddenly burns resulting in higher pressure rise rate, higher premixed phase heat release and noisy engine operation. The same was observed during the engine trial in which engine became noisy with increase in methanol composition in the test fuel. The finding of higher ignition delay was consistent with the findings by Huan et. al. [18] and Yao et.al. [24]. Fig. 7 shows the total combustion duration in °CA for various test fuels. It was found that TCD was reduced to 49° crank rotations for MD05 and 40° crank rotations for MD10 as compared to 58.2° exhibited by baseline. The

reduction in total combustion duration with increased methanol composition was due to the fact that methanol was an oxygenated fuel and its injection and vaporization properties were better than diesel. Again, the laminar flame propagation speed of methanol was higher than diesel resulting in faster combustion [14]. Fig. 8 shows the cumulative heat release over the cycle for all the test fuels. It can be seen that baseline data provided the highest cumulative heat release followed by MD05 and MD10. MD05 exhibited a drop of 1.5% and MD10 showed a drop of 6.7% in cumulative heat release compared to baseline. This reduction in heat release was mainly attributed towards very low heating value of methanol as compared to diesel and very high heat of vaporization of methanol. The results of reduced heat release and combustion duration for test fuels with increasing volume fraction of methanol was consistent with the findings and theories suggested by Sayin, *Ozsezen and Canakci* [11], Huan et. al. [18], Yao et.al. [24], Qi, Chen, Geng, Bian and Ren [26] etc.

B. Emission

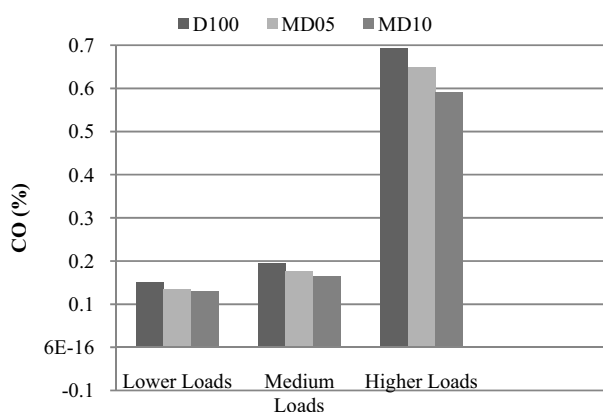

Fig. 9 Emission of CO at various loads

Carbon monoxide is considered as a major diesel engine pollutant. The formation of CO during combustion in diesel engines is primarily attributed to lower fuel-air equivalence ratios of combustible mixtures [27]. However, factors like combustion chamber design, atomization rate, start of injection timing, fuel injection pressure, engine load, speed etc. may affect formation of CO at varied influences [11]. In the present case however, methanol was an oxygenated fuel with an extremely low carbon to hydrogen ratio and its stoichiometric fuel air ratio requirement was nearly 2.2 times higher than mineral diesel as mentioned in Table I. Besides methanol burn leanly due to partially oxidized nature of alcohols relative to hydrocarbons [28]. All these factors led to a reduction in emission of CO with increase in methanol composition in the test fuel. The same may be evident from Fig. 9 that shows reduction in CO emission with increase in methanol volume fraction, invariably reported at all the loads. CO emission was mostly insignificant at lower and medium

loads. But at higher loads it was reduced significantly with increase in methanol composition.

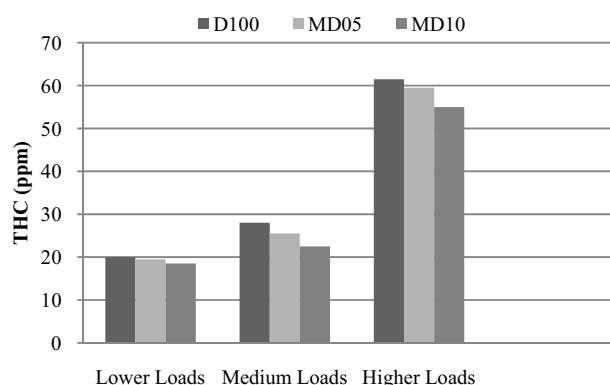

Fig. 10 Emission of THC at various loads

The formation of THC in diesel engines is due to a number factors like retention of unburnt fuels in engine cylinder crevices [29], engine configuration, fuel structure, combustion temperature, oxygen availability, residence time [14] etc. Fig. 10 shows the emissions of THC for various test fuels. Emission of THC was found to increase with increase in engine load, as at higher loads more amount of fuel was injected with constant air supply leading to incomplete combustion. However, a significant reduction in THC emission was observed with increase in methanol composition for all the loads. This reduction in THC compared to baseline with increase in methanol volume fraction was attributed to a couple of factors. Firstly methanol has higher laminar flame propagation speed and oxygen content resulting in shorter combustion duration with increased peak heat release as shown in Fig. 4 heat release curve. The higher peak heat release resulted in higher peak in-cylinder temperature promoting enhanced combustion and reduced THC emissions for blended fuels [14], [30]. Secondly methanol molecules due to their polarity did not get absorbed in the non-polar lubricating oil resulting in reduced THC emissions [31].

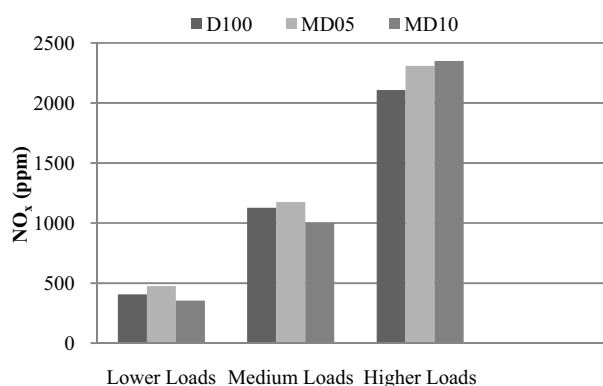

Fig. 11 Emission of NO_x at various loads

Combustion flame temperature, availability of oxygen and time for oxygen-nitrogen reaction are the major factors controlling NO_x formation in diesel engines [32], [33]. NO_x mostly comprises of nitric oxide (NO) and nitrogen dioxide (NO_2), formed by “Zeldovich Mechanism” at high combustion flame temperatures. However, formation of NO_x in methanol blended fuels is governed by a set of conflicting factors. Firstly methanol is an oxygenated fuel; hence, it enhances availability of oxygen inside engine cylinder promoting more NO_x emissions. Secondly the cetane rating of methanol is extremely poor compared to diesel resulting in higher peak heat release leading to higher combustion flame temperature which in turn enhances NO_x emissions. Thirdly the heat of vaporization of methanol is very high and heating value less than half compared to diesel, hence, its vaporization inside combustion chamber results in a strong quenching effect leading to reduced NO_x emission [34], [35]. Fig. 11 shows the emissions of NO_x for various test fuels at different loading conditions. It may be seen that MD05 exhibited higher NO_x emission compared to baseline at all loads confirming the fact that cetane rating and oxygen content were more potent factors for in-cylinder temperature rise than heating value and latent heat of vaporization [11]. On the other hand MD10 exhibited reduced NO_x emissions at lower and medium loads and at higher loads NO_x emission was marginally increased compared to baseline indicating dominance of quenching effect at higher methanol volume fraction.

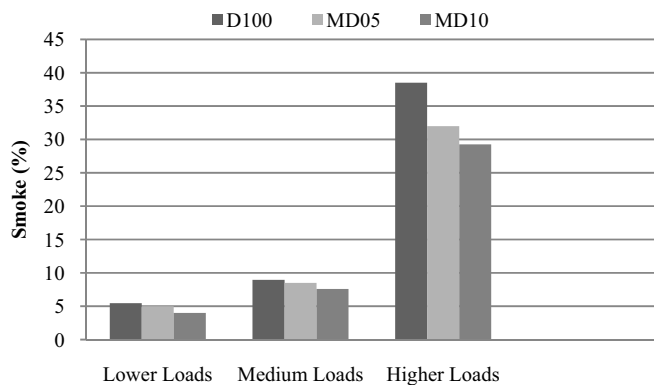

Fig. 12 Smoke opacity at various loads

Smoke opacity for diesel engines generally refers to dry soot emission and particulate matter. The formation of smoke is mainly due to thermal cracking of long chain molecules in oxygen deficit environment [36]-[38]. Fig.12 shows the smoke opacities for various test fuels at different loads. It may be seen that smoke opacity reduced with increase in methanol volume fraction in the test fuel. This may be simply attributed towards the higher oxygen contents of methanol which contained 50% by mass of oxygen in its molecule.

In order to provide a more compact picture of various emissions emanating from methanol diesel blended fuels and its comparison with baseline data, a comparative bar chart is shown in Fig. 13. It shows the percentage difference in full

load emissions of CO, THC, NO_x , Smoke and exhaust temperature compared to baseline.

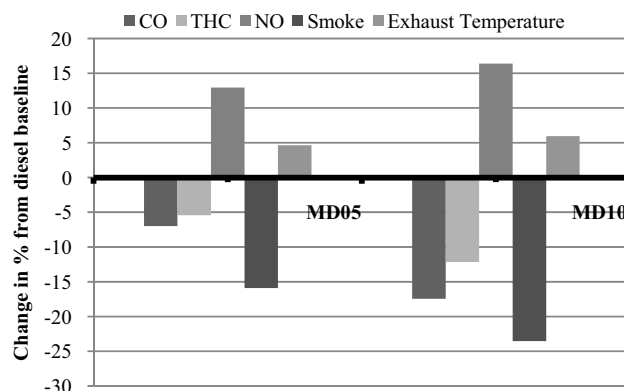

Fig. 13 Percentage change in full load emission of CO, THC, Smoke and Exhaust Temperature compared to diesel baseline

The results in Fig. 13 shows that full load emission of CO gets reduced by 6.97% for MD05 and 17.4% for MD10 compared to diesel baseline. Similarly full load emission of THC was found to get reduced by 5.4% for MD05 and 12.1% for MD10 compared to baseline data of diesel. Smoke opacity at full load also followed the trend exhibiting a substantial reduction of 15.9% and 23.5% over the neat diesel operation. However, full load emissions of NO_x was increased by 12.93% for MD05 and 16.37% for MD10 compared to diesel baseline. The increase in exhaust temperature was marginal with just 4.6% for MD05 and 5.9% for MD10 compared to baseline. On nutshell, increase in volume fraction of methanol in diesel methanol blend leads to lower emissions of CO, THC and smoke with marginal increase in emissions of NO_x and exhaust temperature.

C. Performance

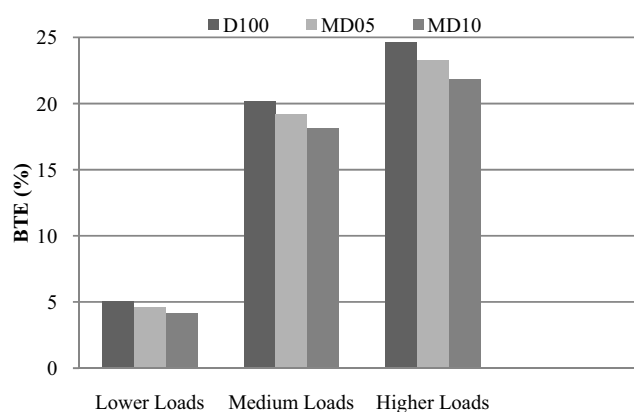

Fig. 14 BTE for test fuels at various loads

Brake thermal efficiency of heat engines indicate the conversion of chemical energy inside the fuel to useful mechanical work produced by engine. Fig. 14 shows the BTE of various test fuels at several loading conditions. It may be

observed that BTE gets reduced with increase in methanol composition in the test fuel. At full load MD05 exhibited BTE of 23.25% and MD10 exhibited BTE of 21.8% as compared to 24.65% shown by baseline data of diesel. This reduction in BTE was attributed to very low heating value of methanol and reduced heat release of blended fuels compared to baseline.

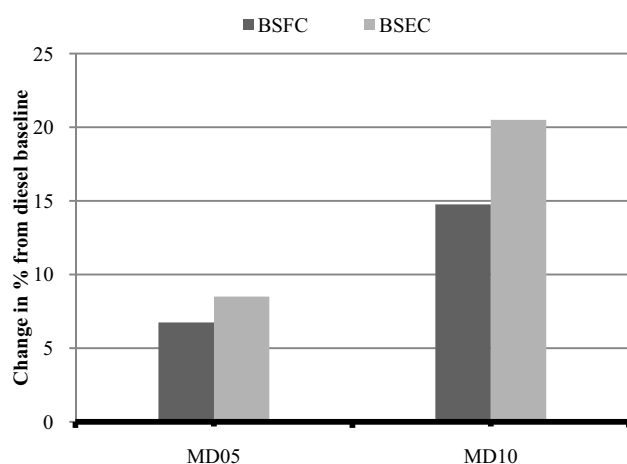

Fig. 15 Percentage change in full load BSFC and BSEC compared to diesel baseline

Brake specific fuel consumption (BSFC) and brake specific energy consumption (BSEC) are the quantitative manifestations of BTE. BSFC indicates the quantity of fuel required to generate one unit of useful work, whereas BSEC shows the amount of fuel energy required to generate one unit of useful work. A comparative assessment of full load BSFC and BSEC for various test fuels is provided in Fig. 15. It may be observed that full load BSFC exhibited by MD05 is 6.75% higher and that of MD10 is 17.76% higher than baseline data. Similarly MD05 showed 8.5% increase and MD10 showed 20.5% increase in full load BSEC compared to neat diesel operation. This increase of BSFC and BSEC for with increase in methanol composition in the test fuels was attributed to lower energy contents of methanol and lower heat release as discussed earlier.

IV. CONCLUSION

The set of exhaustive engine trials conducted and the subsequent analysis leads to the following conclusions.

Higher in-cylinder pressure rise rate was observed for MD05 and MD10 compared to baseline. Ignition delay observed for MD05 was 12° crank rotations and that of MD10 was 17° crank rotations compared to 9.8° reported by baseline data of diesel. Maximum heat release per crank angle was found to get increased with increase in methanol volume fraction indicating higher in-cylinder temperature for blended fuels compared to baseline. Total combustion duration for MD05 was 49° crank rotations and MD10 was 40° crank rotations as compared to 58.2° observed for diesel baseline showing reduction in TCD. Cumulative heat release per cycle

for MD05 was found to get reduced by 1.5% and that of MD10 by 6.7% compared baseline data. Emissions of CO, THC and smoke exhibited significant reduction with increase in volume fraction of methanol in diesel. However, NO_x and exhaust temperature was found to get increased marginally for blended fuels. Full load BTE was reduced by 5.67% for MD05 and 11.56% for MD10 compared to baseline data of diesel. Full load BSFC was increased by 6.75% for MD05 and 14.76% for MD10 compared to baseline data. Following the trend full load BSEC was increased by 8.5% for MD05 and 20.5% for MD10 compared to the baseline data.

On the basis of the results obtained from the engine trials conducted on a single cylinder, water cooled naturally aspirated, direct injection, diesel engine fueled with blends of methanol and diesel, it may be suggested that use of 5% methanol in diesel with a small agitator inside the fuel tank leads to reduced emissions with marginal deterioration in combustion and performance characteristics.

ACKNOWLEDGMENT

The authors express gratitude and thanks for the laboratory and library facilities at “Center for Advanced Studies and Research in Automotive Engineering”, Delhi Technological University, Delhi for support in order to execute the engine trials and the subsequent analysis.

TABLE V
 SYMBOLS AND ABBREVIATIONS

Symbols/Abbreviations	
MD05	Blend of 5% methanol and 95% diesel.
MD10	Blend of 5% methanol and 95% diesel.
TCD	Total combustion duration.
°CA	Degrees of crank angle rotations.
CO	Carbon monoxide
THC	Total unburnt hydrocarbons,
NO _x	Oxides of nitrogen.
BTE	Brake thermal efficiency.
BSFC	Brake specific fuel consumption.
BSEC	Brake specific energy consumption.
ppm	Parts per million
H ₂	Hydrogen gas.
Cu-Zn-Cr	Copper-Zinc-Chromium
°C	Degree Celsius
°K	Degree Kelvin
cSt	Centi-Stoke
MCA	Methanol containing additive
DI	Direct injection
MJ/Kg	Mega joules per kilogram
kWh	Kilo-watt-hour
RPM	Rotations per minute

BTDC	Before top dead center
cc	Centimeter cube
DMCC	Diesel methanol compound combustion
wt. %	Percentage by weight
HRR	Heat release rate
$\frac{dQc}{d\theta}$	Net HRR per °CA
$\frac{dQc}{d\theta}$	Wall heat loss rate per °CA
P	In-cylinder Pressure
V	Volume
m	Mass
R	Universal gas constant
T	Temperature
Cp	Specific heat at constant pressure
Cv	Specific heat at constant volume
h	Convective heat transfer co-efficient
A	Piston wall area
γ	Specific heat ratio
Tw	Cylinder wall temperature
Tj	Ambient temperature
v/v	Volume wise substitution

REFERENCES

- [1] L.J Wang, R.Z Song, H.B Zou, S.H Liu, L.B Zhou. "Study on combustion characteristics of a methanol-diesel fuel compression ignition engine". *Proc Inst Mech Eng D – J Auto* (2008); 222:619–27.
- [2] R.H Thring. "Alternative fuels for spark-ignition engines". SAE 1983.Paper No. 831685. p. 4715–25.
- [3] H. Bayraktar. "An experimental study on the performance parameters of an experimental CI engine fueled withdiesel-methanol-dodecanol blends". *Fuel* (2008); 87:158–164.
- [4] T. Chmielniak, M. Sciazko. "Co-gasification of biomass and coal formethanol synthesis". *Applied Energy* (2003); 74:393–403.
- [5] A. Kowalewicz. "Methanol as a fuel for spark ignition engines: a reviewand analysis". *Proc Inst Mech Eng* (1993); 207:43–52.
- [6] C.H. Cheng, C.S. Cheung, T.L. Chan, S.C. Lee, C.D. Yao, K.S. Tsang. "Comparison of emissions of a direct injection diesel engine operatingon biodiesel with emulsified and fumigated methanol". *Fuel* (2008); 87:1870–1879.
- [7] M.S Kumar, A. Ramesh, B. Nagalingam. "An experimental comparison of methods to use methanol and Jatropa oil in a compressionignition engine". *Biomass Bioenergy* (2003); 25:309–18.
- [8] S.Y Liao., D.M Jiang, Q.Cheng, Z.H.Huang, Q.Wei. "Investigation of the cold start combustion characteristics of ethanol-gasoline blends in a constant-volume chamber". *Energy and Fuels* (2005); 19:813–819.
- [9] J.L. Smith, J.P. Workman. "Alcohols for motor fuels". Colorado State University and U.S. Department of Agriculture. Fact sheet no. 5.010.
- [10] C. Sayin, K. Uslu, M. Canakci. Influence of injection timing on the exhaustemissions of a dual-fuel CI engine. *Renewable Energy* (2008); 33:1314–23.
- [11] C. Sayin, A.N Ozsezen, M. Canakci. "The influence of operating parameters on the performance and emissions of a DI diesel engine using methanol-blended-diesel fuel". *Fuel* (2010); 89:1407–1414.
- [12] T.O Wagner, D.S Gray, B.Y Zarah, A.A Kozinski. "Practicality ofalcohols as motor fuel". SAE 1979. Paper No. 790429. pp. 1591–607.
- [13] Z. Huang, H. Lu, D. Jiang, K. Zeng, B. Liu, J. Zhang, X. Wang. "Combustion behavior of a compression ignition engine fueled with diesel/methanol blends under various fuel delivery advance angles". *Bioresource Technology* (2004); 95: 331–341.
- [14] C. Sayin. "Engine performance and exhaust gas emissions of methanoland ethanol-diesel blends". *Fuel* (2010); 89:3410–3415.
- [15] M.R Chao, T.C Lina, H.R Chao, F.H Chang, C.B Chen. "Effects of methanol-containing additive on emissioncharacteristics from a heavy-duty diesel engine". *The Science of the Total Environment* (2001); 279:167-179.
- [16] C.H. Cheng, C.S. Cheung, T.L. Chan, S.C. Lee, C.D. Yao. "Experimental investigation on the performance, gaseous and particulate emissions of a methanol fumigated diesel engine". *The Science of the Total Environment* (2008); 389: 115–124.
- [17] Z.H. Zhang, C.S. Cheung, T.L. Chan, C.D. Yao. "Emission reduction from diesel engine using fumigation methanol and dieseloxidation catalyst". *Science of the Total Environment* (2009); 407:4497–4505.
- [18] C. Yao, C.S. Cheung, C. Cheng Y. Wang, T.L. Chan, S.C. Lee. "Effect of diesel/methanol compound combustion on dieselengine combustion and emissions". *Energy Conversion and Management* (2008); 49:1696–1704.
- [19] S.X Shi, K.H Zhao, M.L Fu, S.K Wang, Z.Y Sun. "An investigation of using methanol as an alternative fuel for diesel engines". In: *Proceedings of the 15th International Congress on combustion engines*; 1983.
- [20] N.Yilmaz. "Effects of intake air preheat and fuel blend ratio on a diesel engine operatingon biodiesel-methanol blends". *Fuel* (2012); 94:444–447.
- [21] N.Yilmaz. "Performance and emission characteristics of a diesel engine fuelled with biodiesel-ethanol and biodiesel-methanol blends at elevated airtemperatures". *Fuel* (2012); 94:440–443.
- [22] L. Zhu, C.S. Cheung, W.G. Zhang, Z. Huang. "Effect of charge dilution on gaseous and particulate emissions from a dieselengine fueled with biodiesel and biodiesel blended with methanol and ethanol". *Applied Thermal Engineering* (2011); 31:2271–2278.
- [23] J.Faletti, S. C. Sorenson, C. E. Goering. "Energy release rates from hybrid fuels". *Transactions of the ASAE* (1984); 27(2): 322-325.
- [24] Z.HHuang, D.MJiang, K. Zeng, B. Liu, Z.LYang. "Combustion characteristics and heat release analysis of a DI compression ignition engine fueled with diesel-dimethyl carbonate blends". *Proc Inst Mech Eng, Part D, J Automobile Eng* (2003); 217(D7):595–606.
- [25] Heywood JB. *Internal combustion engine fundamentals*. New York: McGraw-Hill Book Company; 1988.
- [26] D.H. Qi, H. Chen, L.M. Geng, Y.ZH. Bian, X.CH. Ren. "Performance and combustion characteristics of biodiesel-diesel-methanolblend fuelled engine". *Applied Energy* (2010); 87:1679–1686.
- [27] A.N Ozsezen, M. Canakci, C.Sayin. "Effects of biodiesel from used frying palm oil on the exhaust emissions of an indirect injection (IDI) diesel engine". *EnergyFuel* (2008); 22:2796–804.
- [28] R.W Rice, A.K Sanyal, A.C Elrod, R.Bata. "Exhaust gas emissions of butanol, ethanol, and methanol-gasoline blends". *J Eng Gas Turbines Power* (1991); 113(3):377–81.
- [29] B. Challen, R.Baranescu. "Diesel engine reference book". 2nd ed. Woburn,MA: SAE and Butterworth Heinemann; 1999.
- [30] T.Wallner, S.AMiers, S. Mc Conell. "A comparison of ethanol and butanol asoxygenates using a DI spark-ignition engine". *J Eng Gas Turbines Power*2009; 131(3):1–9.
- [31] G.Halla, H.ASoliman, O.HBadr, M.FRabbo. "Effect of injection timingon the performance of diesel engine". *Energy Conv Manage* 2002; 43:269–77.
- [32] M.RChao, T.CLin, H.WChao, F.SChang, C.BChen. "Effects of methanol-containingadditive on emission characteristics from a heavy-duty diesel engine". *Sci Total Environ* (2001); 279:167–79.
- [33] R.Stone. "Introduction to internal combustion engines". 3rd ed. Warrendale: SAEInc.; 1999.
- [34] J.Song, K.Cheenkachorn, J.Wang, Perez J, A.LBoehman, P.JYoung. "Effect ofoxygenated fuel on combustion and emissions in a light-duty turbo dieselengine". *Energy Fuel* (2002); 16:294–301.
- [35] J. Huang, Y.Wang, S.Li, A.PRoskilly, H.Yu, H.Li. "Experimental investigation onthe performance and emissions of a diesel engine fuelled with ethanol-dieselblends". *ApplTherm Eng* (2009); 29(11–12):2484–90.
- [36] M.Lapuerta, F.JMartos, M.DCardenas. "Determination of light extinctionefficiency of diesel soot from smoke opacity measurement". *Meas Sci Technol* (2005); 16:2048–55.
- [37] H.HSchobert. "The chemistry of hydrocarbon fuels". England: Butterworth-Heinemann; 1991.
- [38] M.PPickett, D.LSiebers. "Soot in diesel fuel jets: effect of ambient density, andinjection pressure". *Combust Flame* (2004); 138(1–2):114–35.

Chinmaya Mishra, M.Tech (Thermal Engineering), is a postgraduate student in the Department of Mechanical Engineering, Delhi Technological University, Delhi. He completed his undergraduate Mechanical Engineering degree from Biju Pattnaik University of Technology, Rourkela, Odisha in 2010. After one year job in a steel plant he went for his master's degree in Delhi Technological University. Presently he is continuing his major thesis under the supervision of Dr. Naveen Kumar at Center for Advanced Studies and Research in Automotive Engineering. His research interests include development of methyl and ethyl esters of vegetable oil from non-edible oil feedstock, application of various alternative fuels in diesel engines and combustion studies.

Anuj Pal, B.Tech (Automotive Engineering), is an undergraduate student in the Department of Automotive Engineering, Delhi Technological University, Delhi. His research interests include exploration of various alternative fuels like vegetable oils, animal fats, alcohols etc. for engine application, production of methyl and ethyl esters of bio-origin oils using supercritical transesterification, development of various emission reduction technologies, and combustion modelling using computational fluid dynamics etc.

Vishvendra Singh Tomar, B.Tech (Mechanical Engineering), is an undergraduate student in the Department of Mechanical Engineering, Delhi Technological University, Delhi. His research interests include production and quality control of biodiesel from various feedstocks.

Naveen Kumar, PhD, completed his Bachelor of Mechanical Engineering degree from D.E.I., Agra, in 1984, his Master of Technology at IIT Delhi in 1990, and his Ph.D. from the University of Delhi. Dr. Kumar has over 19 years of experience in the industry, teaching, and research, including more than 13 years of teaching at the Delhi Technological University (formerly Delhi College of Engineering), where he is currently a professor in Mechanical Engineering and Head, Biodiesel research. His specialisation is in internal combustion engines and alternative fuels. His research interests include the development of various biofuels and their utilization in decentralized power systems. His work on biodiesel is highly valued internationally. Dr. Kumar has extensively traveled abroad and has interacted with various universities and industries in both developed and developing countries.