

Effects of Operating Conditions on Calcium Carbonate Fouling in a Plate Heat Exchanger

K. Pana-Supparamassadu, P. Jeimrittivong, P. Narataruksa, and S. Tungkamani

Abstract—The aim of this work is to investigate on the internal-flow patterns in a plate heat exchanger channel, which affect the rate of sedimentation fouling on the heat transfer surface of the plate heat exchanger. The research methodologies were the computer simulation using Computational Fluid Dynamics (CFD) and the experimental works. COMSOL MULTIPHYSICS™ Version 3.3 was used to simulate the velocity flow fields to verify the low and high flow regions. The results from the CFD technique were then compared with the images obtained from the experiments in which the fouling test rig was set up with a single-channel plate heat exchanger to monitor the fouling of calcium carbonate. Two parameters were varied i.e., the crossing angle of the two plate: 55/55, 10/10, and 55/10 degree, and the fluid flow rate at the inlet: 0.0566, 0.1132 and 0.1698 m/s. The type of plate “GX-12” (the surface area 0.12 m², the depth 2.9 mm, the width of fluid flow 215 mm and the thickness of stainless plate of 0.5 mm) was used in this study. The results indicated that the velocity distribution for the case of 55/55 degree seems to be very well organized when compared with the others. Also, an increase in the inlet velocity resulted in the reduction of fouling rate on the surface of plate heat exchangers.

Keywords—Computational fluid dynamics, crossing angles, finite element method, plate heat exchanger.

I. INTRODUCTION

NOWADAYS, plate heat exchangers are used worldwide in all industries such as petroleum industry, food industry, pharmaceutical and material industry by replacing shell and tube heat exchangers. Advantages of plate heat exchangers are higher thermal conductivity, higher accuracy of temperature control, lower of contact time, lower construction area, and easier for cleaning than shell and tube heaters [1].

However, disadvantage of plate heat exchangers is fouling (formed by CaCO₃ at high operating temperature) that caused by flow pattern in plate heat exchanger that fouling was defined as the accumulation of unwanted materials on the surface of heat exchanger. It has a lot of problems in design and operation such as the fouling layer has a low thermal conductivity and as deposition occurs, the cross-sectional area was reduced, that causes an increase in pressure drop. Fouling can be separated in six types such as

K. P. is with the Department of Chemical Engineering, King Mongkut's University of Technology North Bangkok, 1518 Piboonsongkhram Rd., Bangsue, Bangkok 10800, Thailand (e-mail: mhc@kmutnb.ac.th, monpilai@gmail.com).

P. J. is with the Department of Chemical Engineering, King Mongkut's University of Technology North Bangkok, 1518 Piboonsongkhram Rd., Bangsue, Bangkok 10800, Thailand (e-mail: karanp@kmutnb.ac.th).

P. N. is with the Department of Chemical Engineering, King Mongkut's University of Technology North Bangkok, 1518 Piboonsongkhram Rd., Bangsue, Bangkok 10800, Thailand (e-mail: phn@kmutnb.ac.th).

S. T. is with the Department of Industrial Chemistry, King Mongkut's University of Technology North Bangkok, 1518 Piboonsongkhram Rd., Bangsue, Bangkok 10800, Thailand (e-mail: mhc@kmutnb.ac.th, monpilai@gmail.com).

crystallization or precipitation fouling, chemical reaction fouling, corrosion fouling, biological fouling or biofouling, freezing fouling and particulate fouling or sedimentation fouling. Particulate fouling has a major problem when sea water and under ground water that contain high amount of calcium ion were used [2]-[5].

Flow characteristics of fluid (angle of fluid flow) in plate heat exchanger are the main parameters that case of fouling form on the surface of plate heat exchanger. Adjustment flow characteristics of fluid by using simulation program can predict fouling of plate heat exchanger. Information of flow characteristics from simulation results can help design team to design heat exchanger which reduces fouling form.

For the experiments, fouling in plate heat exchanger (calcium sulfate as a cold fluid) studied by [6] was shown that heat transfer rate decrease 20 %, pressure drop increased 300-400 %, rate of fouling increase at high temperature and second order was the reaction control. Kinetic model was defined by [7] that shown three steps of fouling, first, initial step that heat transfer rate increase due to roughness of surface area, second step was the fouling form and last step was the constant of thermal conductivity. Fouling was been off by shear force that equal rate of fouling.

For the simulation models, Fouling in plate heat exchanger was studied by computational fluid dynamic that represented one dimensional and shown flow pattern in radius direction [8]-[11] and two dimensional. Two and three dimensional models represented higher accuracy of flow pattern, temperature distribution and fouling than one dimensional model [12], [13]. Three dimensional models shown point of the highest of fouling that occurred at the highest temperature and velocity of fluid flow had effect at initial of two or three of corrugate plate [13].

In the present work, fluid velocity profile in plate heat exchanger was investigated by using the experiment and computational fluid dynamic technique (CFD). The objective was to find the optimum angle of plate heat that low fouling of CaCO₃ occurred.

II. METHODOLOGY

A. Experimental

Experimental equipments of plate heat exchanger were designed for studying flow pattern and fluid distribution at via angle of plat heat which was shown in Fig. 1. The descriptions of equipments and parts were explained in Table I. The plates were set at different angle i.e., 10/10, 55/10 and 55/55, respectively, and plate properties were shown in Table II. In experimental work, a corn powder solution (50% by weight) was used as a replacement for CaCO₃ at the beginning of fouling. Feed flow rate of corn powder solution was set at 0.0566, 0.1132 and 0.1698 m/s, respectively.

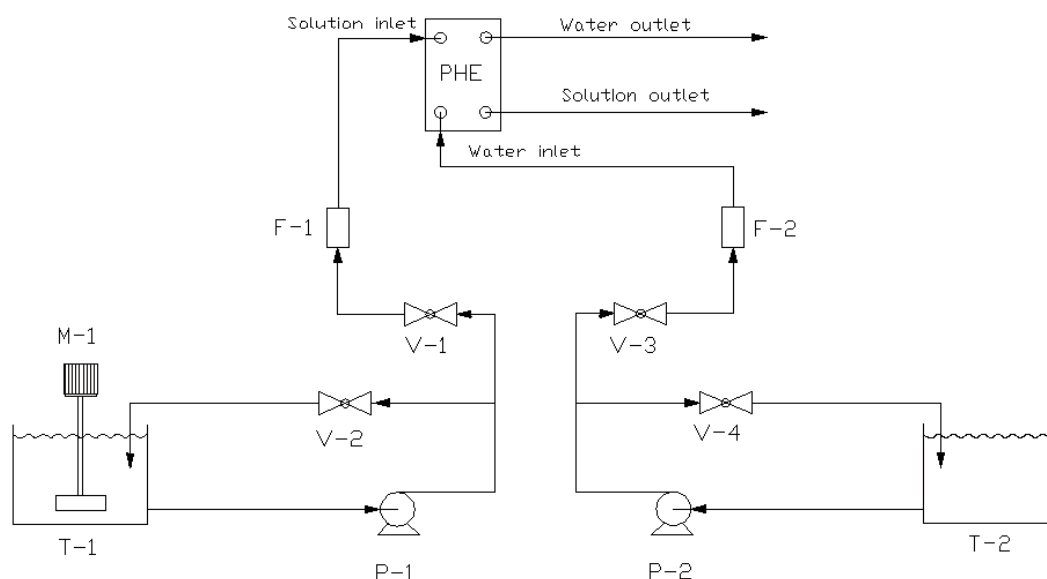

Fig. 1 Schematic diagram of plate-and-frame (PHE) experimental set up for fouling investigation

B. Simulation

Simulation was obtained by using COMSOL MULTIPHYSICS program version 3.3. Characteristics of flow pattern and fluid distribution in plate heat exchanger were investigated via angle of plate heat as shown in Figure 2. Calculation of flow properties in plate heat exchanger was based on mathematical models for the conservation of momentum and mass by the used of Incompressible Navier-Stokes Equations.

$$-\nabla \cdot \eta(\nabla u + (\nabla u)^T) + \rho(u \cdot \nabla)u + \nabla p = 0 \quad (1)$$

where η is fluid viscosity (kg/m-s)

u is fluid velocity (m/s)

ρ is fluid density (kg/m³)

p is pressure (Pa)

3D application mode is used to model some parts of plate heat exchanger. The corresponding computational domains of plate configurations were exhibited in Fig. 3. Density (994 kg/m³) and viscosity (7.2×10^{-4} kg/m-s) of solution was set in Sub-domain setting. In flow/out flow velocity (feed inlet), neutral (side wall) and no slip were set in Boundary setting as shown in Fig. 4(a). The computational mesh fineness was set at Free Mesh Parameter, and Tetrahedral Mesh was adopted as shown in Fig. 4(b). A number mesh element used for 55/55, 10/10, and 55/10 plate configurations were 348034,

375642, and 312737 elements, respectively.

TABLE I
EQUIPMENTS AND PARTS IN THE SET UP

Code	Equipments/Parts
T-1	Stainless Steel Tank AISI 304 (100 liter)
T-2	Stainless Steel Tank AISI 304 (100 liter)
P-1	Centrifugal Pump
P-2	Centrifugal Pump
M-H	Motor
V-1	Globe Valve
V-2	Globe Valve
V-3	Globe Valve
V-4	Globe Valve
F-1	Rotameter
F-2	Rotameter

TABLE II
PLATE SPECIFICATIONS

Material	Stainless Steel ASTM 316
Type	GX-12
Surface Area (m ²)	0.12
Depth (mm)	2.9
Width (mm)	215
Angle H/L (H-pl ⁰)	10/10, 55/55, 55/10
Thickness (mm)	0.5

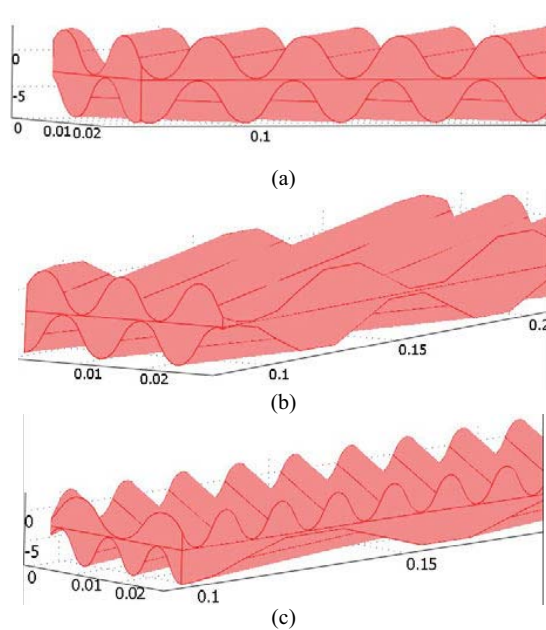

Fig. 3 Computational domain of flow between plates of various configurations: (a) 55/55 degree, (b) 10/10 degree, and (c) 55/10 degree

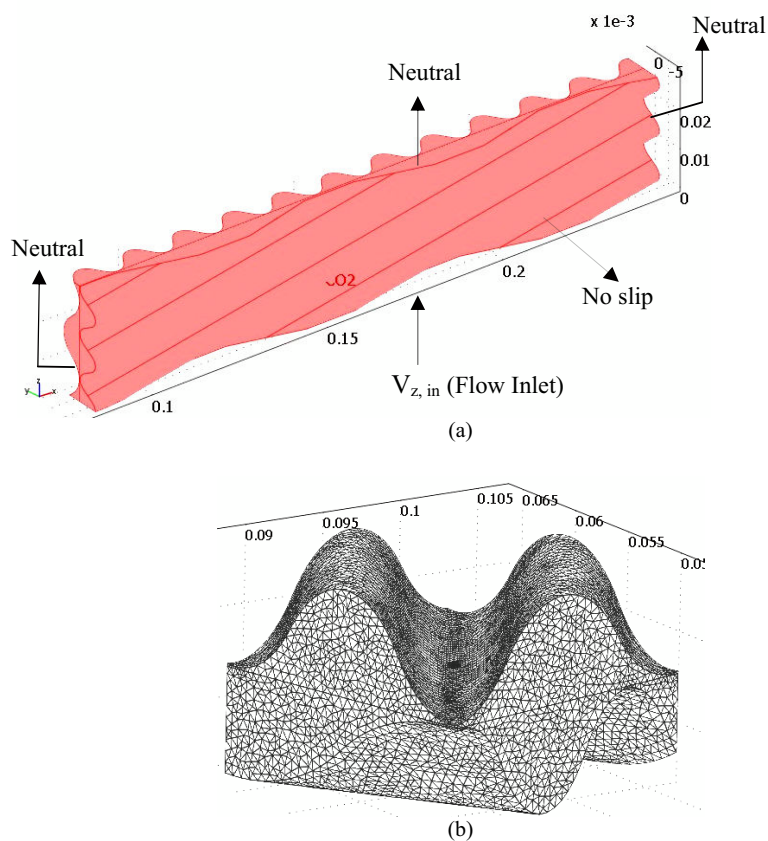

Fig. 4 Computational set up: (a) boundary conditions, (b) mesh in the FE scheme

III. RESULTS AND DISCUSSIONS

Fig. 4(a)-4(c) illustrated the comparison between the simulation and experimental results of flow patterns and velocity distributions within the plate heat exchanger with configurations of 55/55, 10/10 and 55/10 degree, respectively, and the flow velocity at inlet was set at 0.1132 m/s. From plan view or x-y plane, the simulated flow patterns agreed with the experimental results. The results shown in Fig. 4(a) were for the 55/55 degree configuration of the plate heat exchanger. Point 1 in Fig. 4(a) was the contact point where the upper and lower plate were in contact, and point 2 was the location right behind the contact point. The velocity was null at the contact point and increased towards point 3 near the largest cross-sectional area where the local maximum velocity was highest about 0.3 m/s. The experimental image indicated that fouling occurred on the backside of the contact point i.e., at point 2 since a local flow and shear stress were low. On the other hand, point 3 showed no fouling according to the high flow and shear. The pattern of fouling formation extended over the whole plate with well-defined repeated pattern in accord

with the periodicity of the flow field in the z-x, and y-z planes.

Well-defined spots of fouling was noticed in the 10/10 degree configuration as well as shown in Fig 4(b). Even though the fouling formation occurred in a well-defined fashion, only small amount of fouling formed because the flow velocity was relatively higher than the previous case of the 55/55 degree plate. The maximum velocity in this configuration was 0.7 m/s, and found in the z-x plane. On the contrary, there was almost no flow velocity in a certain y-z plane, thus the fouling tended to occur in this section close to the contact and the backside points. The plate heat with the same degree of rotation of the upper and lower plates but in the opposite sense exhibited symmetrical or skew-symmetrical patterns such like those found in the cases of 55/55 and 10/10 degree configuration. In the 55/10 degree plate heat exchanger, the fouling spots appeared on the back of contact points, which formed the diagonal patterns. The velocity distribution in the y-z plane indicated that the high velocity zones were fouling free sites.

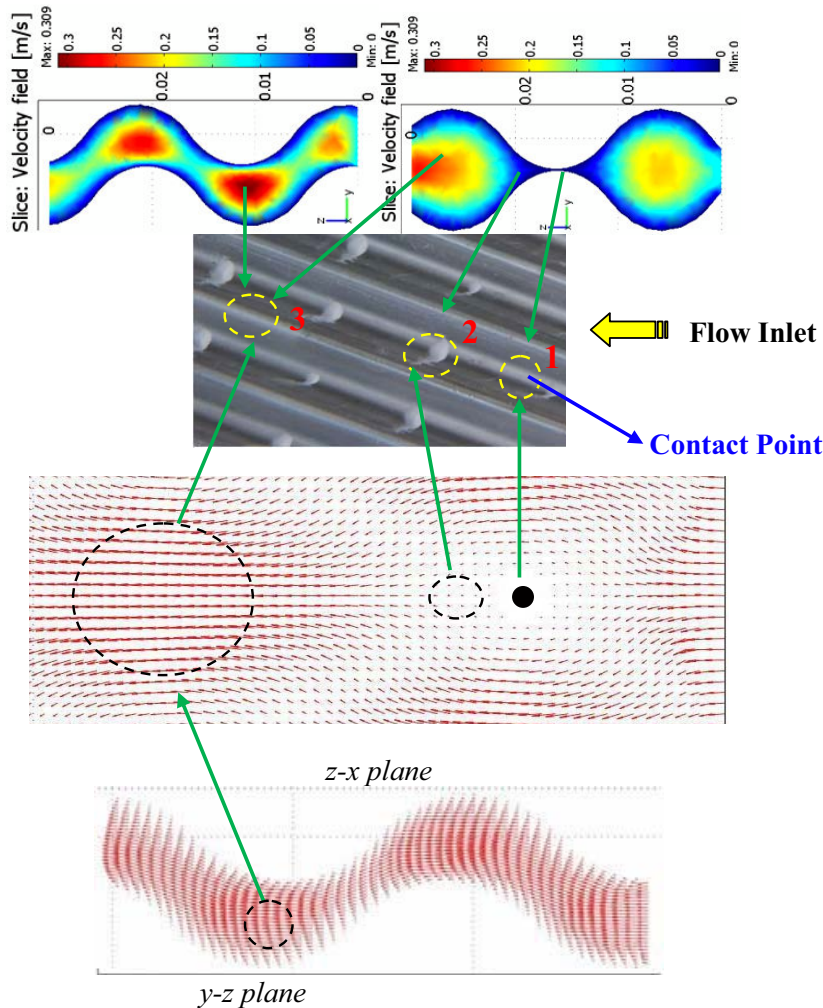

Fig. 4(a) Flow distributions on the z-x, and y-z planes in the case of inlet velocity equalled to 0.1132 m/s (at z=0), and fouling spots on the plate with 55/55 degree configuration

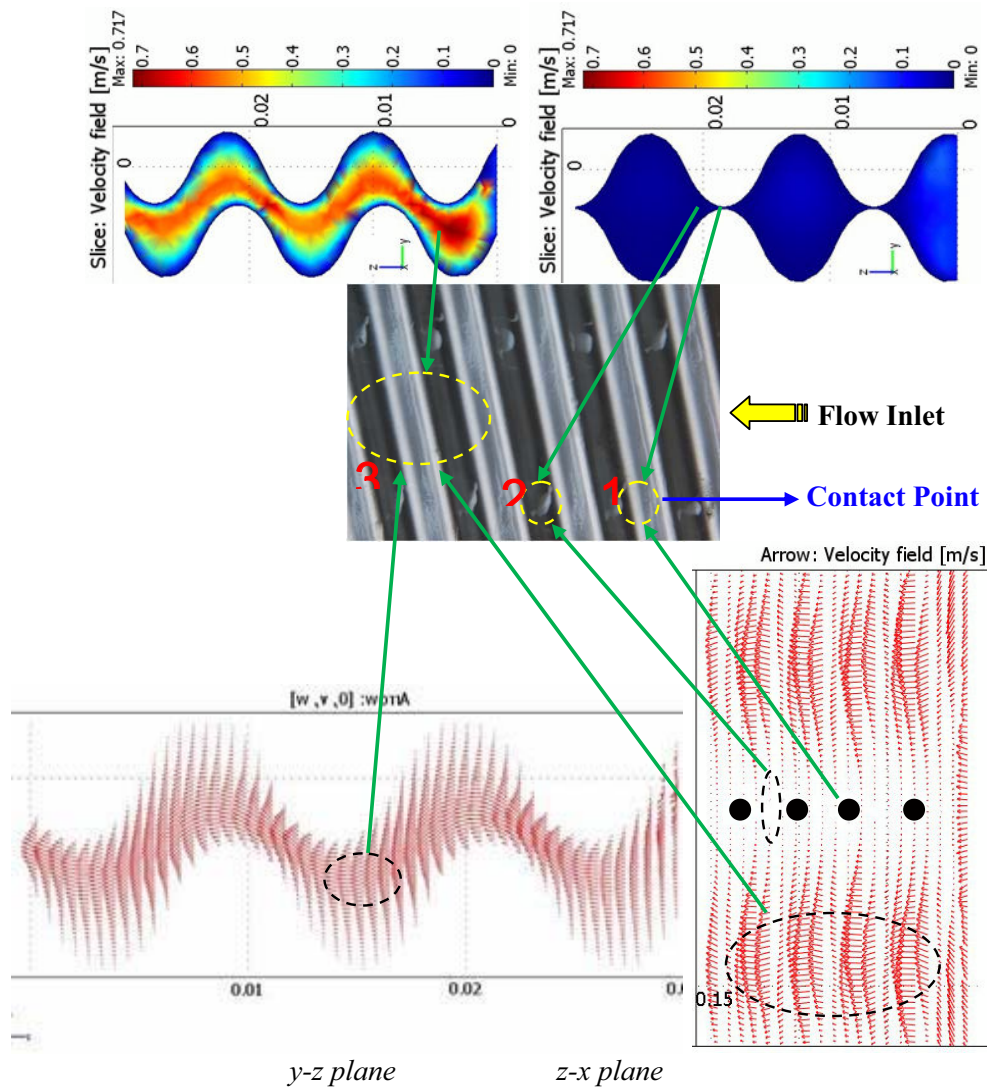

Fig. 4(b) Flow distributions on the z-x, and y-z planes in the case of inlet velocity equalled to 0.1132 m/s (at $z=0$), and fouling spots on the plate with 10/10 degree configuration

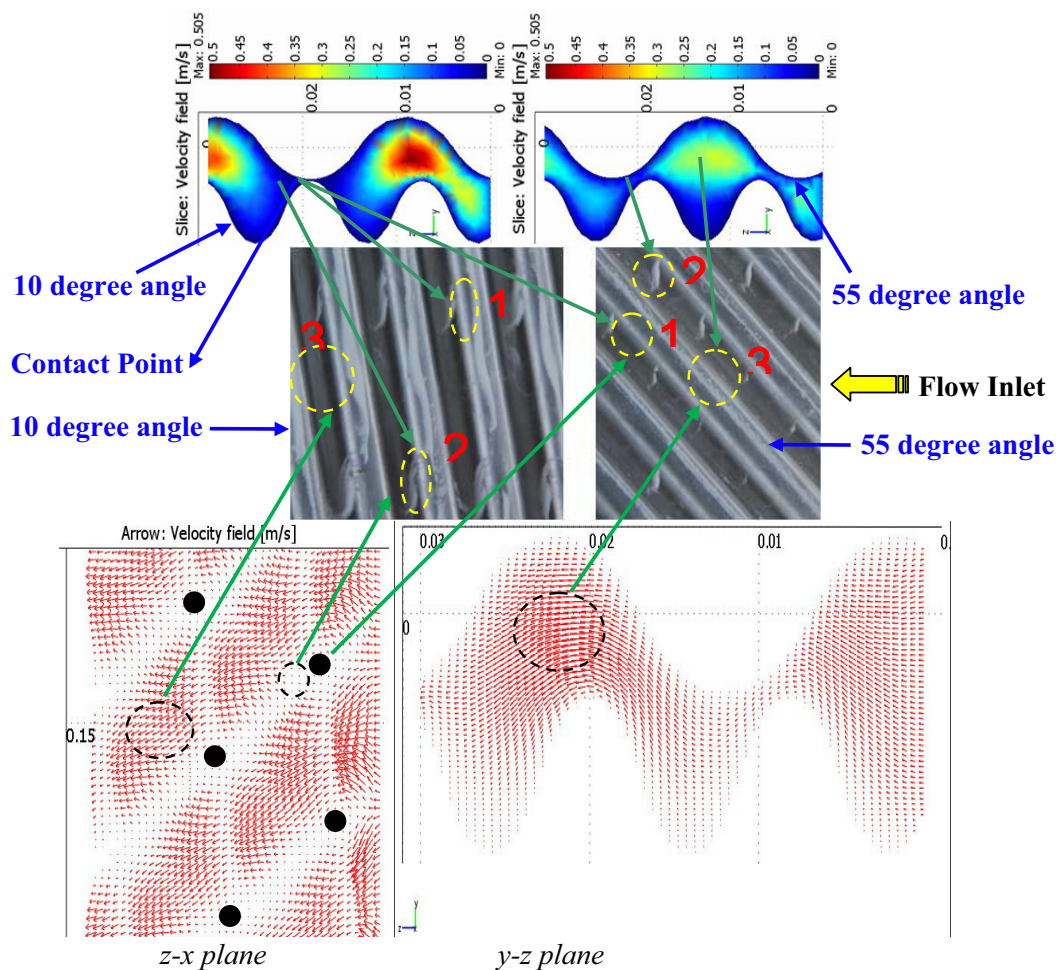

Fig. 4(c) Flow distributions on the z-x, and y-z planes in the case of inlet velocity equalled to 0.1132 m/s (at z=0), and fouling spots on the plate with 55/10 degree configuration

In order to investigate the influence of flow velocity, the inlet velocity was varied as 0.0566, 0.1132, and 0.1698 m/s in the 55/55 degree configuration. Fig. 5(a)-5(c) presented the flow field and matched the simulated flow field with the images obtained from experiments. The overall pattern of fouling sites was similar among the three cases, but the amount of fouling decreased with the increased inlet velocity i.e., in Fig. 5(a) at the lowest flow of 0.0566, fouling occurred more, and fouling became lesser at 0.1132, and 0.1698 m/s as seen in Fig. 5(b) and 5(c), respectively. At low flow rate, there was insufficient shear to overcome a fouling process, whereas a high shear available at high flow rate was sufficient to prevent or lessen fouling formation.

Fig. 6(a) presented 5 points at different fluid velocity of plate angle 55/55 of x direction. The results were shown that low fluid velocity was found at point 2, 4 and 5 (contact point area) and high fluid velocity was found at point 1 and 3. Fig. 6(b) presented 5 points at different fluid velocity of plate angle

10/10 of x direction that all points had low fluid velocity due to fluid distribution occurred at different direction. Fig. 6(c) presented 5 points at different fluid velocity of plate angle 55/10 of x direction that point 3 shown minimum fluid velocity due to this angle break up fluid flow.

Fig. 7(a) presented 5 points at different fluid velocity of plate angle 55/55 of y direction. The results were shown that low fluid distribution occurred at all point of this angle due to fluid distribution occurred at different direction. Fig. 7(b) presented 5 points at different fluid velocity of plate angle 10/10 of y direction that point 1,2, and 3 represented low fluid distribution and point 4 and 5 represented high fluid distribution because these points were close to contact point. Fig. 7(c) presented 5 points at different fluid velocity of plate angle 55/10 of y direction that all points had low fluid velocity due to fluid distribution occurred at different direction.

Fig. 8(a) presented 5 points at different fluid velocity of plate angle 55/55 of z direction. The results were shown that high fluid distribution occurred at all point of this angle. Fig. 8(b) presented 5 points at different fluid velocity of plate angle 10/10 of z direction that point 1, 2 and 3 shown low fluid distribution and point 4 and 5 shown high fluid

distribution. Fig. 8(c) presented 5 points at different fluid velocity of plate angle 55/10 of z direction that point 1, 2 and 3 shown low fluid distribution and point 4 and 5 shown high fluid distribution. Fig. 9(a)-9(c) illustrated the averaged velocity for the corresponding crossing angles.

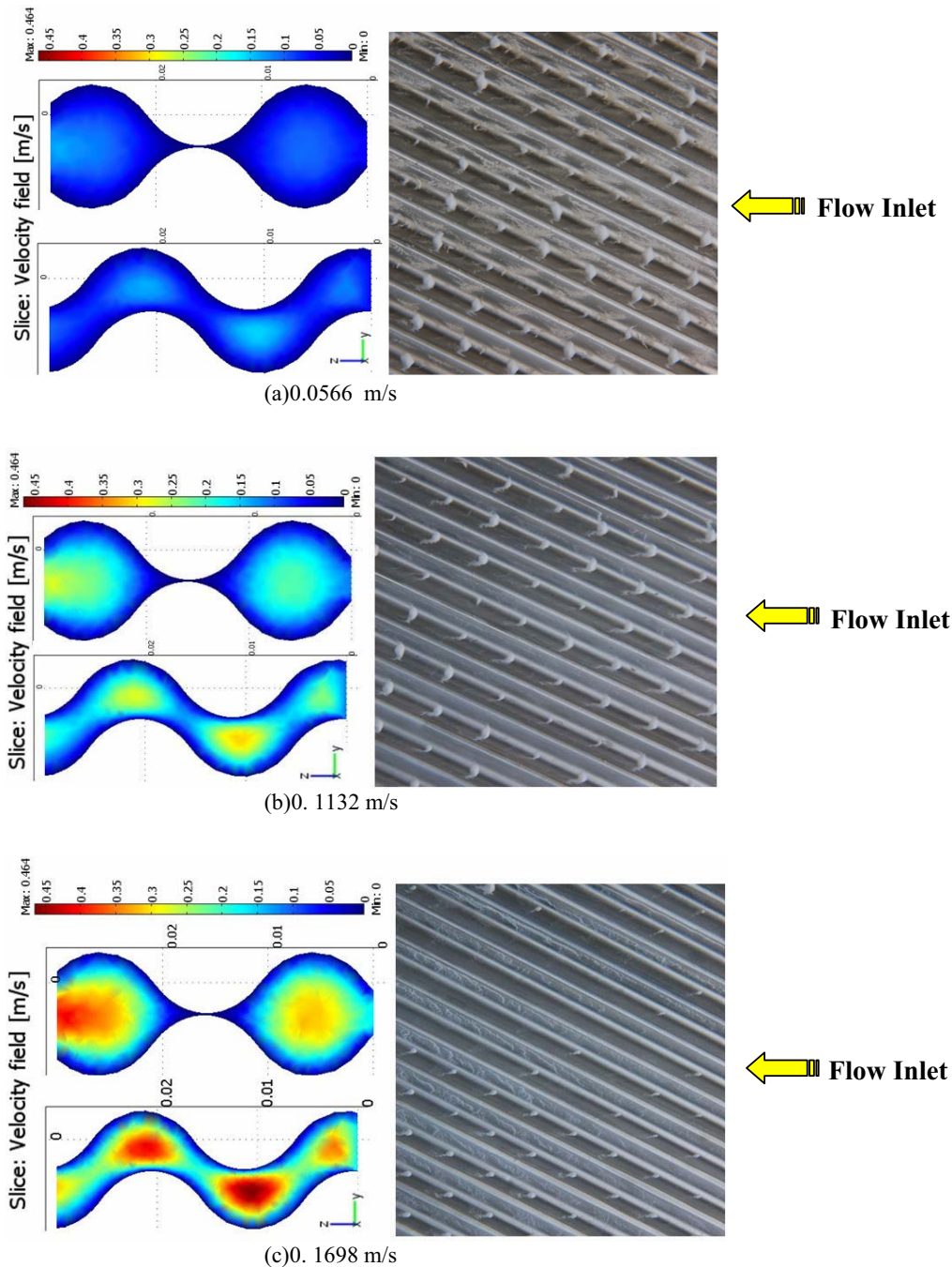
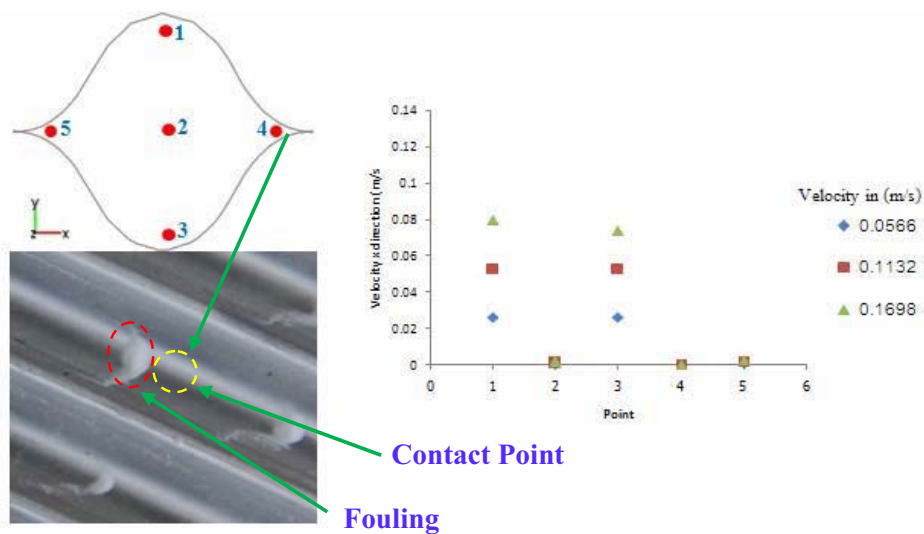
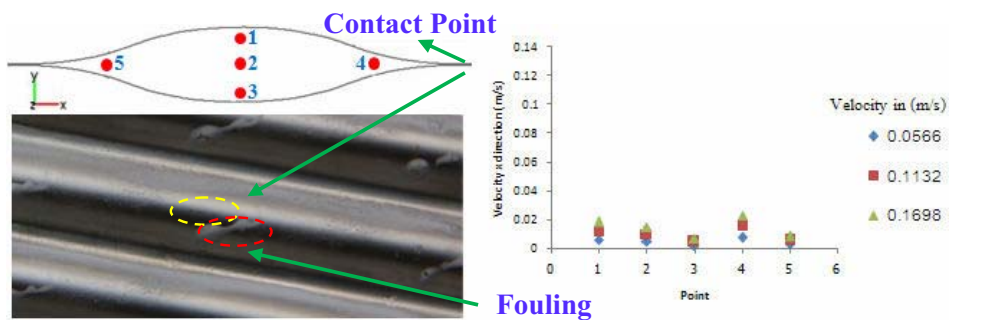

Fig. 5 Matching the simulated flow field and fouling formation in the 55/55 degree plate configuration at (a) 0.0566 m/s (b) 0.1132 m/s, and (c) 0.1698 m/s.



(a)



(b)

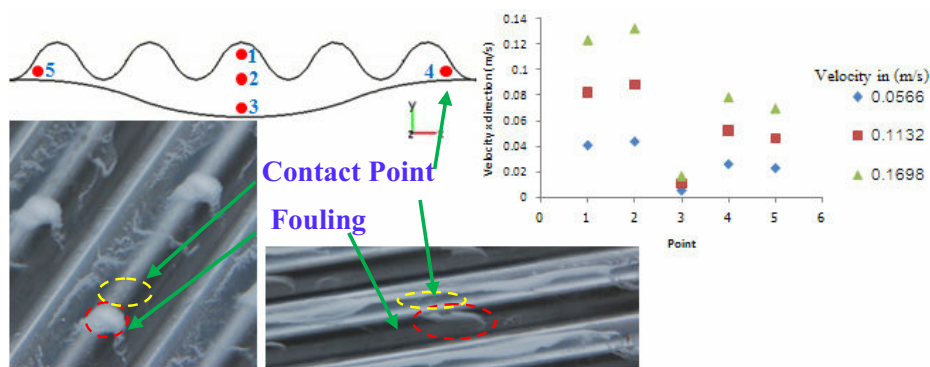

(c)

Fig. 6 Distribution of the velocity component in x-direction of each plate configuration: (a) 55/55, (b) 10/10, and (c) 55/10

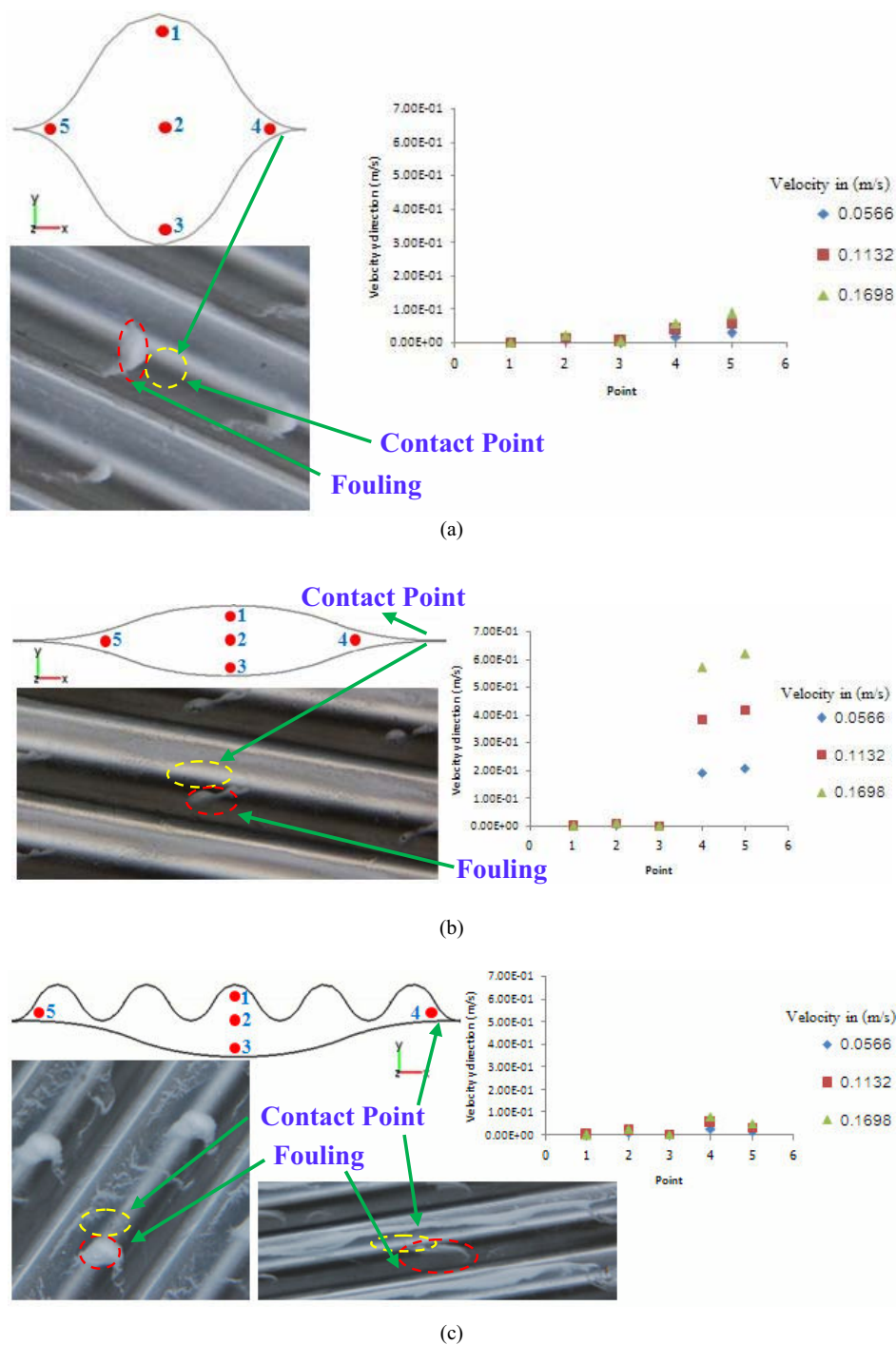

Fig. 7 Distribution of the velocity component in y-direction of each plate configuration: (a) 55/55, (b) 10/10, and (c) 55/10

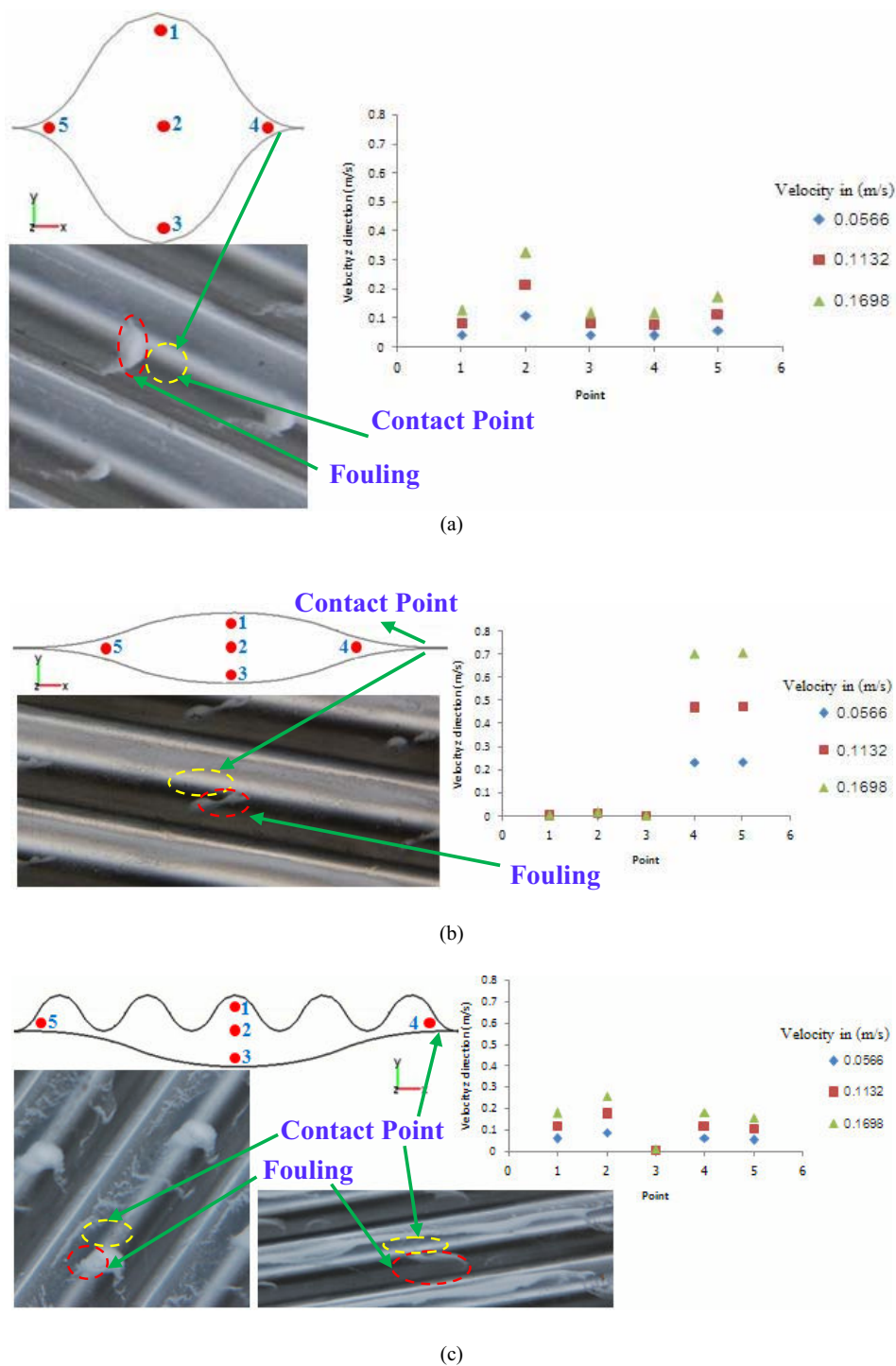

Fig. 8 Distribution of the velocity component in z-direction of each plate configuration: (a) 55/55, (b) 10/10, and (c) 55/10

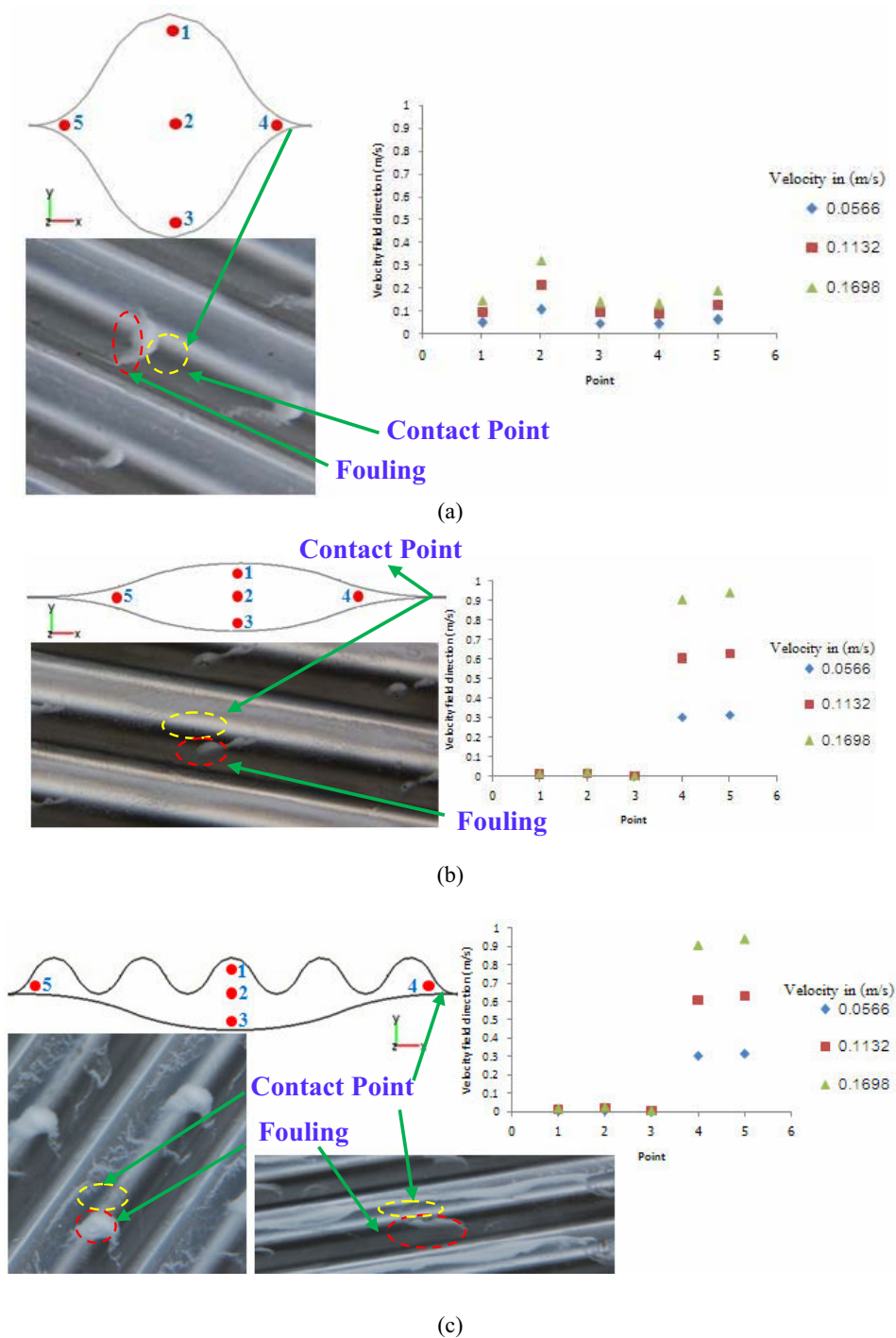

Fig. 9 Distribution of the averaged velocity of each plate configuration: (a) 55/55, (b) 10/10, and (c) 55/10.

IV. CONCLUSION

The research methodologies were the computer simulation using Computational Fluid Dynamics (CFD) and the experimental works for finding fluid distribution and flow pattern in a plate heat exchanger at different feed inlet velocity and crossing angles of plate heat exchanger. The simulation results agreed very well with the experimental results. Both approaches shown that at the high feed inlet velocity, and the high crossing angle could reduce fouling significantly. The fouling tended to occur around the dead spot of low velocity and circulation. Thus for the GX-12 plate, the recommended design was the using of the crossing angle of 55/55, and the feed of 0.1698 m/s.

ACKNOWLEDGMENT

This work was supported by Department of Chemical Engineering. The authors wish to thank the Department of Chemical Engineering for simulation software and Department of Industrial Chemistry for thesis funds.

REFERENCES

- [1] M. C. Georgiadis, and S. Macchietto, "Dynamic modeling and simulation of plate heat exchangers under milk fouling," *Chemical Engineering Science*. Vol. 55, pp. 1605-1619, 2000.
- [2] J. C. Cowan, and D.J. Weintritt, *Water- Formed Scale Deposits*. Houston, TX: Gulf Publ. Co., 1976.
- [3] S.H. Lee, and J.G. Knudsen, "Scaling characteristics of cooling tower water," *ASHRAE Trans*. 85 (Part 1). pp. 281-302, 1989.
- [4] A. P. Watkinson, "Water quality effect on fouling from hard waters," J. Taborek et al. (Eds.), *Heat exchangers Theory and Practice*. Washington, WA: Hemisphere Publ. Co., 1983, pp. 853-861.
- [5] A. Cooper, J.W. Suitor, and J.D. Usher, "Cooling water fouling in plate heat exchangers," *Heat Transfer Eng*. Vol. 1(3), pp. 50-55, 1980.
- [6] B. Bansal, and H. M. Muller-Steinhagen, "Crystallisation fouling in plate heat exchangers," *ASME J. Heat Transfer*. Vol. 115, pp. 584-591, 1993.
- [7] J. A. W. Gut, R. Fernandes, J. M. Pinto, and C. C. Tadini, "Thermal model validation of plate heat exchangers with generalized configurations," *Chemical Engineering Science*. Vol. 59, pp. 4589-4598, 2004.
- [8] C. C. Lakshmanan, and O. E. Potter, "Dynamic simulation of plate heat exchangers," *International Journal of Heat and Mass Transfer*. Vol. 33(5), pp. 995-1002, 1990.
- [9] X. Luo, X. Guan, M. Li, and W. Roetzel, "Dynamic behavior of one-dimensional flow multistream heat exchanger and their networks," *International Journal of Heat and Mass Transfer*. Vol. 46, pp. 705-715, 2003.
- [10] B. P. Rao, P. K. Kumar, and S. K. Das, "Effect of flow distribution to the channels on the thermal performance of a plate heat exchanger," *Chemical Engineering and Processing*. Vol. 41, pp. 49-58, 2002.
- [11] C. P. Ribeiro, and M. H. C. Andrade, "An algorithm for steady-state simulation of plate heat exchangers," *Journal of Food Engineering*. Vol. 53, pp. 59-66, 2002.
- [12] S. Jun, V. M. Puri, and R. F. Roberts, "A dynamic model for thermal performance of plate heat exchangers," *Transactions of the ASAE*. Vol. 47(1), pp. 213-222, 2003.
- [13] K. Grijspeerdi, B. Hazarika, and D. Vucinic, "Application of computational fluid dynamic to mode the hydrodynamic of plate heat exchanger for milk processing," *Journal of food engineering*. Vol. 57, pp. 237-242, 2003.