

# Comparative Study of Sustainable Architecture in Stairway-like Ushtobin Village, Iran

<sup>1</sup>Ahadollah Azami, <sup>2</sup>Alireza Sadeghi, <sup>3</sup>Zargham OstadiAsl, <sup>4</sup>Hamed Pirjani, <sup>5</sup>Milad Babaei

**Abstract**—Stairway Ushtobin Village is one of the five villages with original and sustainable architecture in Northwest of Iran along the border of Armenia, which has been able to maintain its environment and sustainable ecosystem. Studying circulation, function and scale (grand, medium and minor) of space, ratio of full and empty spaces, number and height of stairs, ratio of compound volume to luxury spaces, openings, type of local masonry (stone, mud, wood) and form of covering elements have been carried out in four houses of this village comparatively as some samples in this article, and furthermore, this article analyzes that the architectural shapes and organic texture of the village meet the needs of cold and dry climate. Finally, some efficient plans are offered suiting the present needs of the village to have a sustainable architecture.

**Keywords**—Sustainable Architecture, Local Materials, Village Texture, Form, Skeleton

## I. INTRODUCTION

THE well-known Ushtobin Village is the center of the rural district of east Dizmar beside Aras River and along the border of Iran-Armenia. This village is limited to Aras River which flows along the fourteen-kilometer distance away from it on the north. Ushtobin is 237 kilometer far from the of province's central city. Ushtobin is a historic village with beautiful stairway architecture; where the yard of one house is the roof of the other one. This historic village is a complex of three small villages and is a sample of mountainous and valley villages [1].



Fig. 1 Aerial photo and topography, Ushtobin Village

F. A. Author is a master and researcher at Department of Architecture, Jolfa International Branch, Islamic Azad University, Jolfa, IRAN. (E-mail: Azami@iauj.ac.ir).

S. B. Author is a researcher at Department of Architecture, Azarshahr Branch, Islamic Azad University, Azarshahr, IRAN. (E-mail: A.sadehi75@yahoo.com)

T. C. Author is a researcher at Department of Architecture, Shabestar Branch, Islamic Azad University, Shabestar, IRAN. (E-mail: Z.ostadiasl@yahoo.com).

F. D. Author is a researcher at Department of Architecture, Marand Branch, Islamic Azad University, Marand, IRAN. (E-mail: Hamed.pirjani@yahoo.com).

F. E. Author is a researcher at Department of Architecture, Lahijan Branch, Islamic Azad University, Lahijan, IRAN. (E-mail: Milad.babaei@yahoo.com).

## II. SKELETON OF THE VILLAGE

Qanat is composed of an open opening and an underground tunnel like vessel and some vertical shafts which connect the other shaft and vice versa [3].

### A. Existing Land Use in Village

Total area of Ushtobin village is 73254.28 square meters, and among the land improvement, residential use with 30.09 percent of the whole village area is dominant; while other uses allocate the following percentages to themselves: religious use, educational use, gardens, Store place, and springs; 0.77%, 4.05%, 5.61%, 1.03%, 0.03% respectively.

## III. VILLAGE TEXTURE MORPHOLOGY

### A. Combination of Areas, Full and Empty Spaces

Since the skeleton of the village is tightly packed and there are dense constructions: the luxurious and roofed spaces are considered as full spaces: the yards, pathways, gardens, debris and arid lands are considered as empty spaces. From historical view point, empty spaces are fewer and full spaces are more, and there again empty spaces include pathways, yards and main squares of villages [2].



Fig.2: Aerial photo and topography

### B. Main Square of the Village and its Improvement

The main square is almost in the center of the village and it would be improved using local masonry including: small and big rubble stones, ax stone and common stone; these could fulfill future needs maintenance sustainable architecture of the village [3].



Fig 3 Main square of Ushtobin village

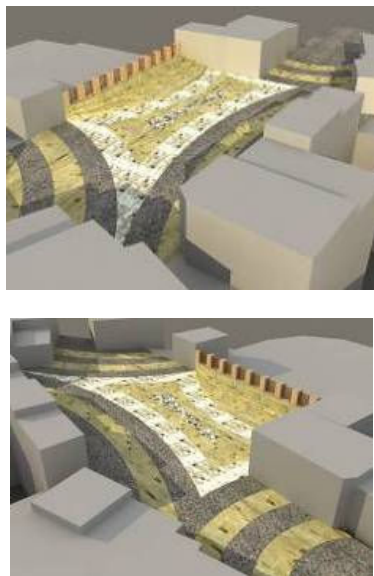

Fig 4 Proposed design for Main Square of Ushtobin Village

### C. Improving Spring Surrounding of the Village

To improve this environment a plan was introduced not only to recover the historical-natural values but also prevent from wasting spring water to attract natural-architectural tourism to the village [4].

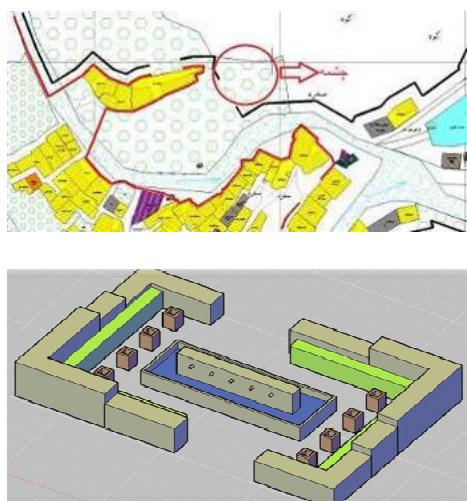

Fig 5 Main spring location and proposed plan to improve the spring, Ushtobin Village

## IV. COMPARATIVE STUDY OF DIFFERENT VILLAGE HOUSES

Four types of houses named Sorkhaei, Nabati, Khodaverdizadeh and Salmanzadeh having rich architecture are selected. After conducting necessary studies and analysis in the field of spaces and organizing function of the spaces including: a) functional diagrams, b) spatial circulation, c) number and connection of floors, d) ratio of empty spaces to luxurious ones, e) number of openings, the sustainable plans were proposed to each of these house types [5].

### A. Functional Diagrams

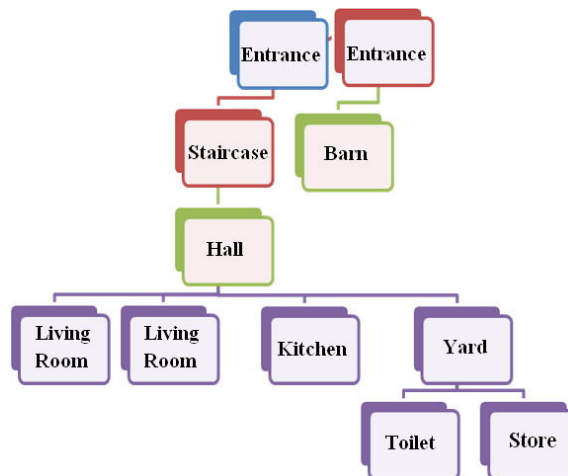

Fig 6 Functional diagram of Sorkhaei House,

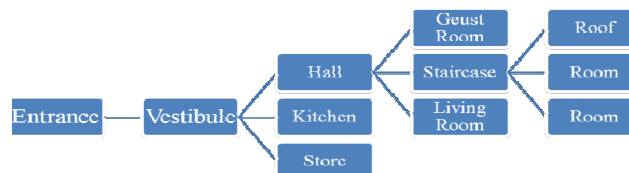

Fig 7 Functional diagram of Salmanzadeh House,

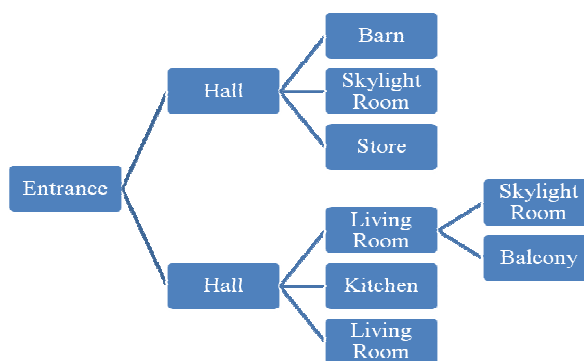

Fig 8 Functional diagram of Khodaverdizadeh House,

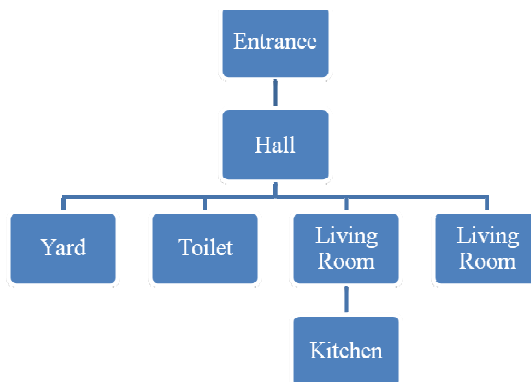

Fig 9 Functional diagram of Nabati House

**B. Circulation**

TABLE I  
 CIRCULATION IN 4 HOUSES, USHTOBIN VILLAGE

	Circulation in Ground Floor Plan	Circulation in First Floor Plan
<b>Sorkhaei House</b>		
<b>Salmanzadeh House</b>		
<b>Khodaverdizadeh House</b>		
<b>Nabati House</b>		

**C. Number and Access of Floors**

Although the heights of the floors are rather different, both Sorkhaei and Salmanzadeh houses have two floors and the relation between stairs is through staircase [6]. While Khodaverdizadeh house has two floors which are not related, Nabati house has only one floor.

**D. Ratio of Empty Space to Luxurious Space**

Sorkhaei House: ratio of empty space to luxurious space: 0.28;

Salmanzadeh House: ratio of empty space to luxurious space: 0.21;

Khodaverdizadeh House: ratio of empty space to luxurious space: 0.08;

Nabati House: ratio of empty space to luxurious space: 0.28.

**E. Openings**

Sorkhaei house: 4 windows, 2 doors, area: 8.07; wall area: 47.12; percent of openings to wall: 17.12;

Salmanzadeh house: 6 windows, 1 door, area: 13.65; wall area: 66; ratio of empty space to luxurious space: 0.21; percent of openings to wall: 20.68;

Khodaverdizadeh house: 3 windows, 1 door, area: 7.52; ratio of empty space to luxurious space: 0.08; wall area: 67.26; percent of openings to wall: 11.18;

Nabati house: 4 windows, no door (north façade), area of north façade: 7.01; wall area: 58.29; percent of openings to wall: 12.02.

TABLE II  
 OPENINGS OF 4 HOUSES IN USHTOBIN

	Openings on the Façade
<b>Sorkhaei House</b>	
<b>Salmanzadeh House</b>	
<b>Khodaverdizadeh House</b>	
<b>Nabati House</b>	

**F. Proposed Plans**

In general, efficient plans for these houses are offered in the following diagram including future needs of the residents and regarding the form and combination, the spaces are different for each house.



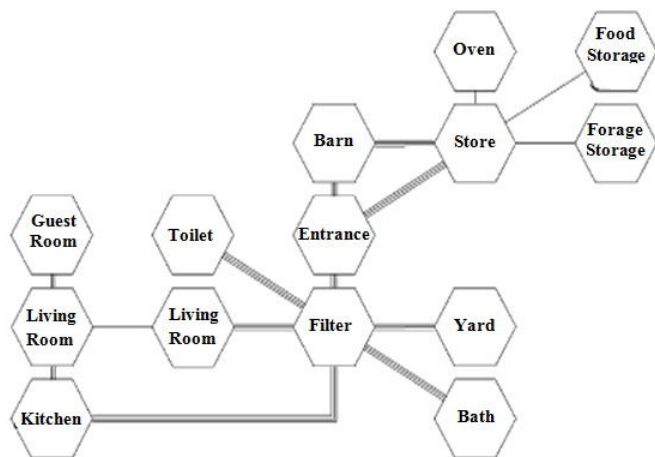

Fig 10 Proposed diagram for new houses in Ushtobin Village

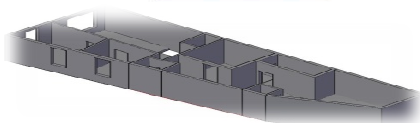
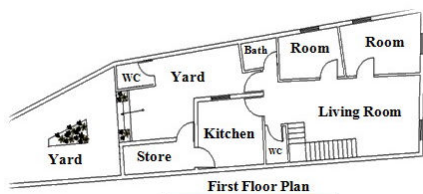
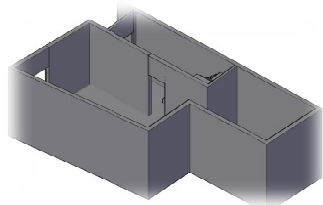
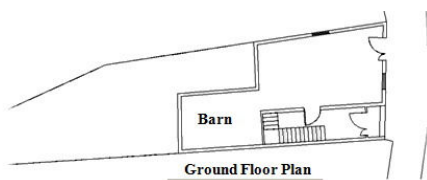

Fig 11 Proposed design for Sorkhaei House

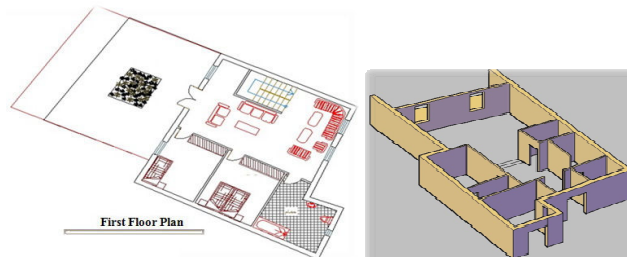
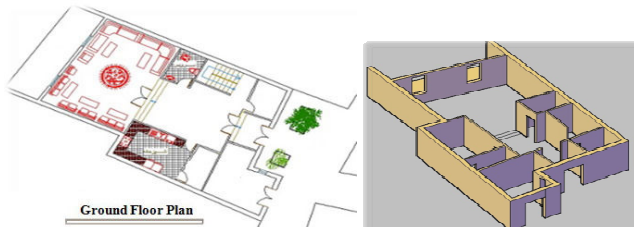

Fig 12 Proposed design for Salmanzadeh House

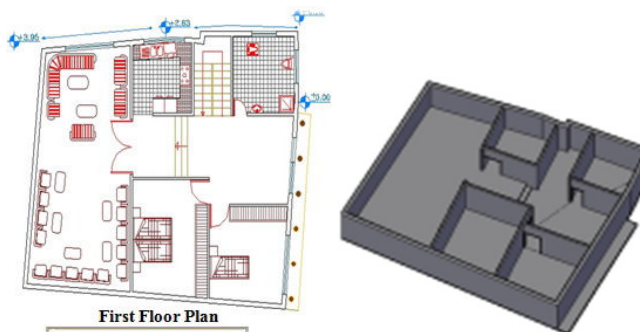
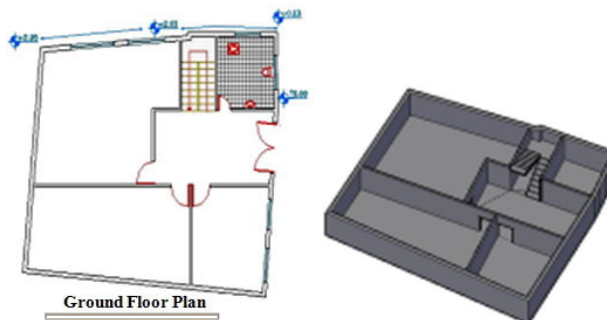

Fig 13 Proposed design for Khodaverdizadeh House

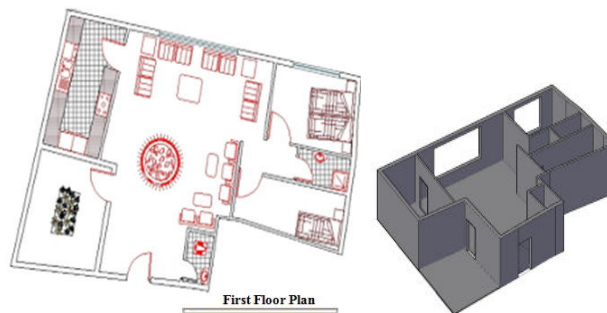

Fig 14 Proposed design for Nabati House

#### V. BUILDING MATERIALS

The main sustainable and traditional building masonry which are used in this village to resist against weather conditions are as follows:

a) Stone: Due to the resistance against humidity, stone has an effective role in foundations and is used as infrastructure in adobe walls.

b) Adobe: As one the common building masonry and for its trustable quality that prevents heat, exchange adobe is always noticed. However, it is easily broken if a sudden quake happens and it should always be taken care of to resist against erosion caused by weather.

c) Wood: Ease of application and no need to special skill, using less working force, etc. are the reasons to use wood in constructing residential buildings.

To avoid rain penetration into the plain roofs of the houses, an insulator in the form of a mud cover which is sometimes mixed with clay is used in this village as well. On the whole, local materials are used in four sample houses. It means stone and mud straw mixture are used in harmony with wood and then the façade is whitened.

## VI. TYPE, FORM AND QUALITY OF THE MAIN COVERING ELEMENTS

### A. Roofs

Roof is made by some main and secondary timbers which are put vertically to each other and wooden sheets of four polish timber are pegged into them to make a strong channel and they are covered by an insulating layer of nylon or mat on which clay is poured and finally all are covered with a layer of mud straw mixture special for caulking.

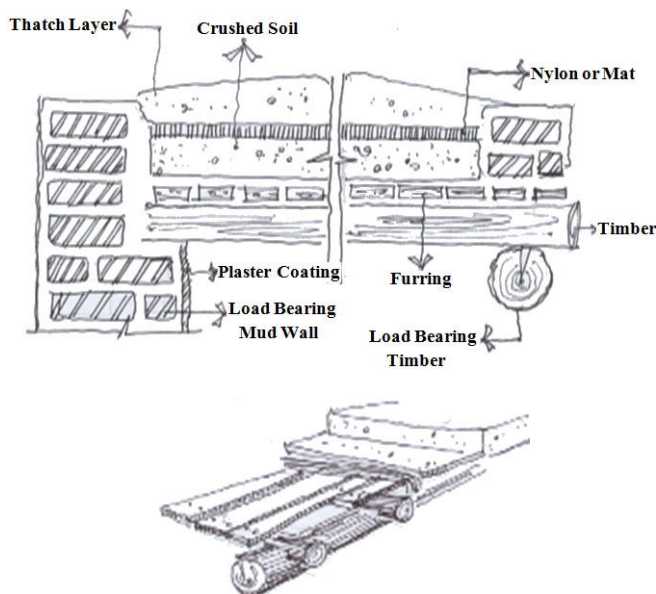

Fig 16 Roof covering details in Ushtobin Village Houses

### B. Column and Foundation

Rubble stone is laid with different angles to distribute column force to different parts. Adobe, vertical foundation, white plaster cover, four polish timber, load bearing wall detail with hidden foundation, vertical and horizontal hasps, masonry and details connecting brick wall to stone wall, girder [7].

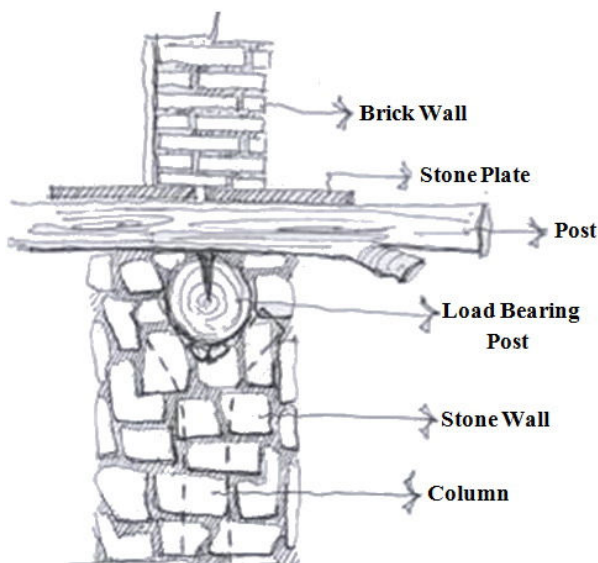

Fig 15 Connection details of brick wall to stone wall in Ushtobin Village Houses

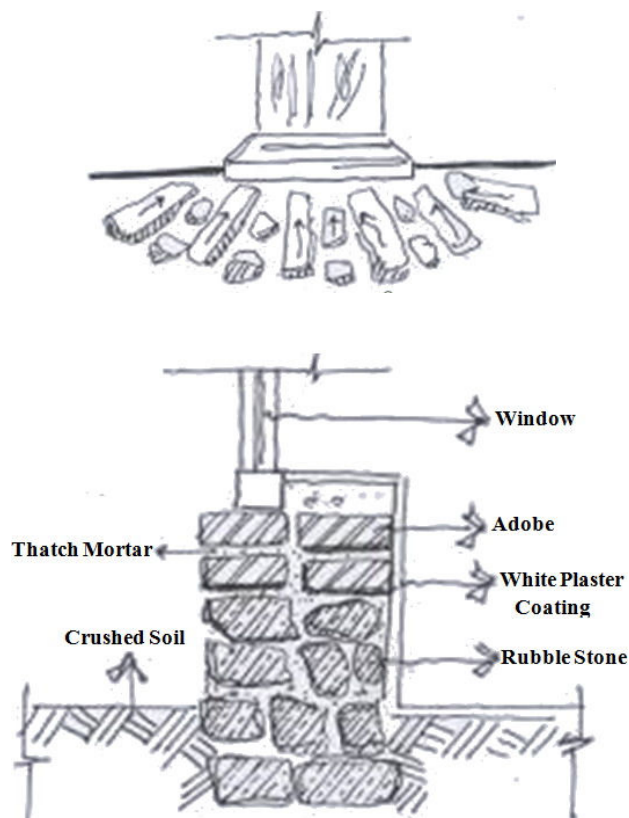

Fig.17: Wall details in Ushtobin Village Houses

### VIII. CONCLUSION

Owing to having all cultural and artistic heritages, the typical and old architectural works visualize special sight and beside other displays and products of the artificial environment as the meaning and value of the village space these architectural works create special image in people's mind. Therefore, in distinguished village architecture, the matter of welfare and paying attention to the needs of the residents of a building considering existing condition without unconsidered imitation and incorrect elements is the base of architectural work.

The main principles considered in local architecture of Ushtobin Village located in cold and dry area of Iran are as follows:

- Use of compressed and compact plans;
- Minimizing ratio of external area to building area;
- Use of high heat resistant masonry;
- Minimizing exchange of inner space air and natural ventilation to avoid heat loss;
- Use of plain roof to keep snow as natural heat insulator;
- Darkening cover of external façade to maximize use of sun heat.

Generally speaking, sustainable renovation of constructions of a village would be based on gathering and analyzing the data and identifying ecological resources and the ecological capacity. But, it should be considered that this village and the like constructed relying on sustainable architecture and energy should not be threatened or destroyed in order to supply the needs of today or due to lack of sustainable planning it should not lose their identity and texture.

### REFERENCES

- V. Ghobadian, *Climatic Analyses of Iranian Traditional Architecture*, Tehran, TEH: Tehran University Publications, 1998, pp. 82-91.
- M. Fateh, *Architect Villages*, Tehran, TEH: Science & knowledge, 2009, pp. 43-53.
- A. Moradi, *Twelve Lessons on Restoration*, Tehran, TEH: Centre for Architecture and Urban Studies and Restoration, 2008. 119-22.
- Y. Farid, *Geography Application in Research Method of Urban and Rural*, Tabriz, TBZ: Tabriz University, 1993, 17-32.
- M. Naghizadeh, "Urban Design and Architecture Effects on Cultural values", *Fine Arts.I.*, Vol. 3, No.10, pp. 54-57, June 2002.
- H. Zomorshidi, *Iran Architecture-Understanding of Iranian Masonry Construction Materials*, Tehran, TEH: Azadeh, 2006, 44-52.
- G. McNally, *Soil and Rock construction Material*, London, E & FN EPSON, 1998, 63-72.

**First Author** Architect Ahadollah Azami was born in Marand, Iran in 1977 and received his M.Sc. degrees in Architectural Engineering from Islamic Azad University of Tabriz, Iran. He is head of Iranian Domestic Technologies Society in the north west of Iran, and Young Researchers Club at Azad University of Jolfa in Iran. Meanwhile he is coordinator of Swedish Ecological Centre (EKOCENTRUM) in the north west of Iran and also member of International Solar Energy Society (ISES), ASES, IRSES, ASCE, and ASME.

He developed the original of old and ancient sustainable architectural methods to contemporary functions especially in the field of Sustainable solar architecture, urban design and zero energy buildings. His researches are focused on various topics such as culture, education, water, solar buildings; technical restoration and renovation of historical buildings and sites approaching sustainability and development. He has one invention in solar

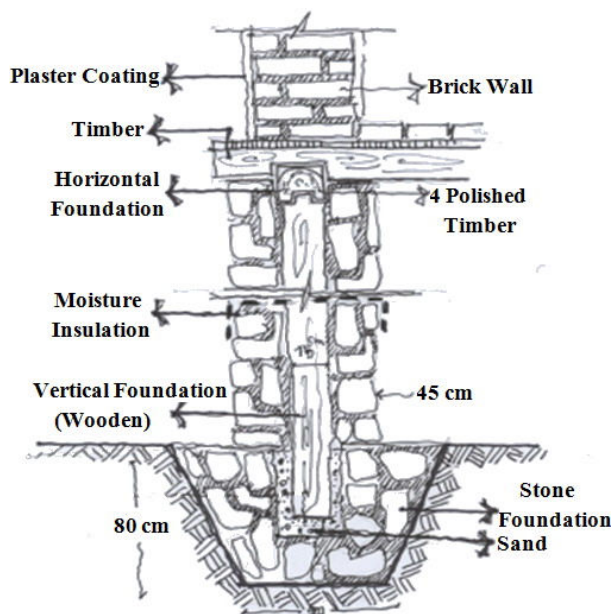

Fig.18: Detail of load bearing wall with vertical foundation in Ushtobin Village Houses

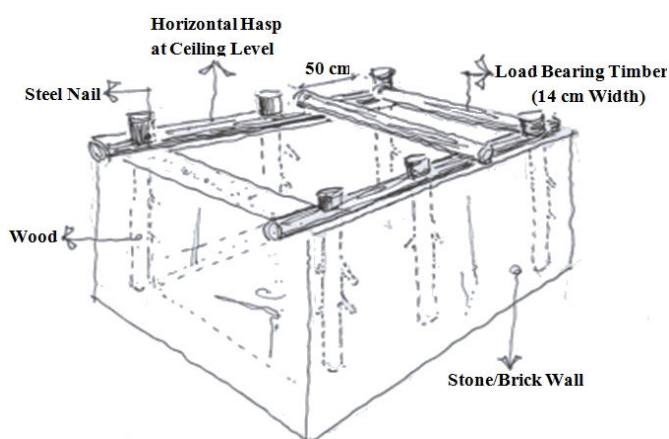

Fig.19: Horizontal & vertical hasps in load bearing walls in Ushtobin Village Houses

### VII. ALLEY TEXTURE

The alley has organic texture and is renovated by time lapse. It is SABAT (completely roofed pathway) form in some cases to both make a connection with the layers on top of it and create suitable functional spaces and secure its space against weather condition.



Fig.20: Alley texture in Ushtobin Village



architecture and has awarded some national and international prizes around the world. He has delivered keynote speeches at national and international conferences on renewable energies and published as an author or co-author over 50 scientific papers in reviewed journals or presented at international conferences. He is awarded UNESCO paper prize at 4<sup>th</sup> IWHA Conference, Paris, France and also awarded second paper prize from 44<sup>th</sup> Int. PLEA conference from SBSE, Milwaukee, Wisconsin, USA in 2005.