

Overhead Estimation over Capacity of Mobile WiMAX

Saeed AL-Rashdy, Qing Guo

Abstract—The IEEE802.16 standard which has emerged as Broadband Wireless Access (BWA) technology, promises to deliver high data rate over large areas to a large number of subscribers in the near future. This paper analyze the effect of overheads over capacity of downlink (DL) of orthogonal frequency division multiple access (OFDMA)–based on the IEEE802.16e mobile WiMAX system with and without overheads. The analysis focuses in particular on the impact of Adaptive Modulation and Coding (AMC) as well as deriving an algorithm to determine the maximum numbers of subscribers that each specific WiMAX sector may support. An analytical study of the WiMAX propagation channel by using Cost-231 Hata Model is presented. Numerical results and discussion estimated by using Matlab to simulate the algorithm for different multi-users parameters.

Keywords—BWA, mobile WiMAX, capacity, AMC , overheads.

I. INTRODUCTION

WITH the publication of the IEEE 802.16 standard by June 2004, representing a distillation of the most advanced technology and an industry consensus permitting equipment interoperability, broadband wireless has gained a maturity and is, theoretically, ready for utilization within metropolitan networks [9]. These 802.16 networks are able to provide high data rates and are preferably based, for non-line-of-sight applications, on Orthogonal Frequency Division Multiple Access (OFDMA) [10].

In recent years, there has been a considerable growth in demand for high-speed wireless internet access and this has caused the emergence of new long-range wireless technology. In particular IEEE 802.16 offers an alternative to the current wired access networks such as cable modems and digital subscriber line (DSL) links. The IEEE 802.16 has become an attractive alternative as it can be deployed rapidly even in areas where it is difficult for wired infrastructures to reach, and can better cover a broad geographical areas in an economical and time efficient manner than compared to traditional wired systems.

The first specification of metropolitan area wireless networks was approved under the IEEE 802.16 standard with the product certification name WiMAX. The IEEE 802.16 2004 standard was developed to add NLOS (Non-line-of-sight) Applications support to the basic standard.

This standard serves fixed and nomadic users in the frequency range of 2-11 GHz. In order to add mobility to wireless access, the WiMAX IEEE 802.16e 2005 specification was defined utilizing frequencies of 6 GHz. A system profile defines the subset of mandatory and optional physical and Medium Access Control (MAC) layers features selected by the WiMAX forum, from the IEEE 802.16 -2004 or IEEE 802.16e-2005 standard.

In this paper, we assess the effect of overheads over capacity of downlink (DL) of orthogonal frequency division multiple access (OFDMA)–based on the IEEE802.16e mobile WiMAX system with and without overheads. The analysis focuses in particular on the impact of Adaptive Modulation and Coding (AMC).The rest of paper is organized as follows: in Section II we present mobile WiMAX PHY and MAC layers; in Section III we present the WiMAX capacity calculation; in Section IV we introduce the overheads analysis. in Section V we provide a simulation result and analysis be have concluding the paper in Section VI.

II. MOBILE WiMAX PHY AND MAC LAYERS

A. OFDMA

At present almost all upcoming broadband access technologies including Mobile WiMAX and its competitors use OFDMA. WiMAX allows almost any available spectrum width to be used. Allowed channel bandwidths vary from 1.25 MHz to 28 MHz. The channel is divided into many equally spaced subcarriers, some of which are used for data transmission while others are reserved for monitoring the quality of the channel (pilot subcarriers). The remaining subcarriers are used as guard subcarriers and DC subcarrier. The data and pilot subcarriers are modulated using one of several available modulations and coding schemes (MCS).

The WiMAX profiles only use Time Division Duplexing (TDD) in which the transmission consisting of the frames shown in Fig. 1. The downlink (DL) subframe and uplink (UL) subframe are separated by a transmit-to-transmit gap (TTG) and receive-to-transmit gap (RTG). The frames are shown in two dimensions with frequency along the vertical axis and time along the horizontal axis [1].

This work was supported by the National Science and technology Major Project: Wireless Innovative Campus Area Networks (Grant No. 2010ZX03005-003). The authors greatly acknowledge their supports.

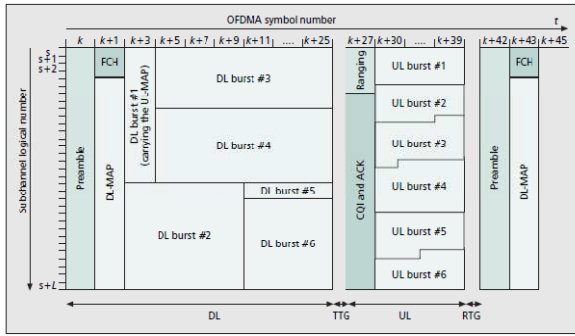

Fig. 1 A Sample OFDMA frame structure

Subtracting the guard subcarriers and the DC subcarrier from the total subcarriers gives the set of used subcarriers. For both the uplink and downlink, these subcarriers are allocated as pilot subcarriers and data subcarriers according to one of the defined OFDMA permutation modes. Two families of permutation modes exist: diversity and contiguous. The most common diversity permutation mode is the Partial Usage of the Sub-Channel (PUSC). A sub-channel is the minimum transmission unit in an OFDMA frequency dimension. A slot in the OFDMA PHY has both a time and sub-channel dimension. A slot is the minimum possible data allocation unit in the 802.16 standard. The slot definition for downlink PUSC is 1 sub-channel x 2 OFDMA symbols; Uplink PUSC is 1 sub-channel x 3 OFDMA symbols [2].

B. Mobile WiMAX MAC layer Structure

The MAC layer of WiMAX is comprised of three sub-layers: a service-specific convergence sub layer, a common part sub layer, and a privacy sub layer. The common part sub layer is the core functional layer which provides bandwidth and establishes and maintains connections. Moreover, as the WiMAX MAC provides a connection-oriented service to the subscriber stations (SS), the common part sub layer also provides a connection identifier (CID) to identify which connection the MPDU (MAC Protocol Data Unit) is servicing. The common part sub layer defines five QoS classes: Unsolicited Grant Service (UGS); real-time Polling Service (rtPS); enhanced real time Polling Service (ertPS); non real-time Polling Service (nrtPS) and Best Effort (BE). UGS support constant bit rate (CBR) applications such as VoIP without silence suppression. rtPS support variable bit rate (VBR) applications like video transmission and ertPS support voice with silence suppression [4].

Table I list the number of bytes per slot for various MCS values. For each MCS, the number of bytes is equal to (bits per symbols x Coding Rate x 48 data subcarriers and symbols per slot / 8 bits). For 10 MHz channel and 3:1 DL: UL ratio, the DL symbol equal to 28. Thus the DL subframe will consist of 14*30 slots.

C. AMC and Cell-Range Estimation

Adaptive modulation and coding allows the WiMAX system to adjust to the signal modulation scheme depending on the signal to noise ratio (SNR) condition of the radio link. When the radio link is high in quality, the highest modulation

scheme is used and gives the system more capacity. Values of the receiver SNR assumptions are proposed in Table 266 of the IEEE 802.16e amendment of the standard (see Table I, first three columns) [3].

In this paper we study different AMC in the presence of path loss only without neglecting the overarching concept of BWA technology. These results in the division of the cell into r regions, $i = 1 \dots r$ (see Fig. 2), which we assume to be concentric circles of radius R_i for simplicity. In each region, users have the same modulation scheme. To calculate the area covered by each modulation scheme, we must determine the maximal distance R_i between BS and users using a corresponding modulation [5]. This distance is determined using the path loss calculation as follows.

The COST-231 Hata model as the path loss model is incorporated. The COST-231 model [6] is an extension to the Hata-Okumura model that also has corrections for rural, suburban, and urban areas. The basic path loss equation for suburban areas is:

$$PL[dB] = 46.3 + 33.9 \log_{10}(f) - 13.82 \log_{10}(h_b) - ah_m + 44.9 - 6.55 \log_{10}(h_b) \log_{10}(R) + C_m \quad (1)$$

f is the frequency in MHz, h_b is the height of the BS in meters, R is the distance from the BS to the receiver in kilometers, h_m is the receiver height in meters, C_m is a standard deviation constant, 0dB for suburban or rural environments and 3dB for urban environments. For suburban or rural areas, the term $a(h_m)$ is defined as follows:

$$a(h_m) = [1.1 \log_{10}(f) - 0.7] h_m - [1.56 \log_{10}(f) - 0.8] \quad (2)$$

And for urban areas, the term $a(h_m)$ is defined as follows:

$$a(h_m) = 3.2 [\log_{10}(11.75 h_m)]^2 - 4.97 \quad (3)$$

$$PL[dB] = PE[dB] - SNR[dB] - N[dB] \quad (4)$$

PE is the emitted power and we consider the case of antennas in BS and user equipment without gain. N is the thermal noise (in units of decibels) which is equal to:

$$N[dB] = 10 \log_{10}(\tau T W) \quad (5)$$

Where $\tau = 1.38 \cdot 10^{-23}$ W/K-Hz is the Boltzmann constant, T is the temperature in Kelvin ($T = 290$) and W is the transmission bandwidth in Hz [5].

Using these equations, we can calculate the relationship between the distance and the SNR as follows:

$$R = 10^{\frac{PE[dB] - SNR[dB] - N[dB] - 46.3 - 33.9 \log_{10}(f) - 13.82 \log_{10}(h_b) + a(h_m) - C_m}{10[44.9 - 6.55 \log_{10}(h_b)]}} \quad (6)$$

For the sake of illustration, let us consider the following example based on the licensed band for mobile WiMAX at a frequency of 2.5GHz and the system bandwidth equal to 5MHz. At this bandwidth, the thermal noise is equal to -136.99dB.

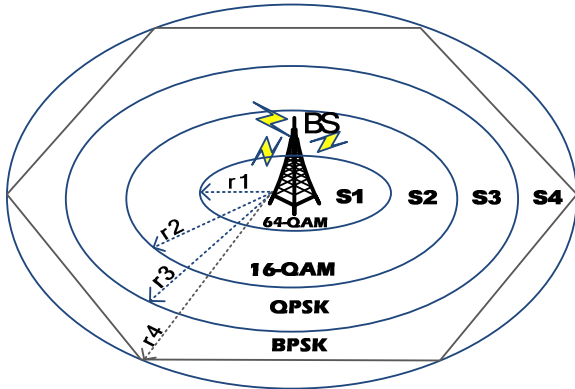

Fig. 2 Cell decomposition into regions

The transmitted power is fixed and equal to 1W. The BS antenna is considered to be 35 m above the ground. The SS antennas heights are fixed at 1.5 m above the ground in suburban environment. Considering the above mentioned assumptions in (6) for each value of SNR, a certain amount of distance from BS will be obtained. Considering minimum SNR for each MCS according to Table I, the maximum radiuses of each MCS region are obtained (as shown in column 5 of the table). Thus, we can determine the areas of each MCS region for each scenario with specific conditions.

III. WiMAX CAPACITY CALCULATION

The system capacity refers to the numbers of connections that the wireless channel can support without unduly degrading the data service carried on the channel.

In WiMAX networks, the MAC protocol is connection oriented and time is divided into frame of fixed duration. Moreover, MAC signaling is in band, i.e. any frame carries both data and control messages. Therefore, the capacity available for data transmission is affected by the overhead due to the control message whose size in turn depend on several factors including the number of subscriber stations that are scheduled in a frame.

In WiMAX wireless channels the situation is considerably more complex. The channel is not necessarily of fixed size but can vary with time as environment conditions change. The capacity of the cell affected by the overheads symbols associated with data symbols in MAC and PHY layer and the amount of signaling overhead is not constant and changes with the number of users in an unpredictable manner.

A. Modulation Distribution

In order to analyze the capacity of a base station (BS) the modulation distribution of area under cover must be available. According to IEEE 802.16e standard support for QPSK, 16QAM and 64QAM are mandatory in the downlink (DL) with mobile WiMAX; in uplink (UL) 64QAM is optional. Both convolutional code (CC) and convolutional turbo code (CTC) with variable code rate and repetition coding are supported.

TABLE I
 RECEIVER SNR (VALUES OF THE IEEE 802.16E)

Modulation	Coding	Receiver SNR (dB)	Byte/slot	Maximum radius for mentioned example (m)
BPSK	1/2	3.0	3	680.1263
QPSK	1/2	6.0	6	557.6335
	3/4	8.5	9	472.5868
QPSK	1/2	11	12	557.6335
	3/4	14	18	472.5868
64-QAM	2/3	19.0	24	235.8517
	3/4	21.0	27	206.6071

According to the MAC technology shown in table I, the system tries to assign the highest level modulation level to each subscriber to maximize the overall throughput.

B. Application Distribution

This section examines and introduces the different application classes of WiMAX and specifies a reliable approximation for the desired parameter and usage percentage related to each of the applications.

In [7] general service flows related to each application can be identified with two major rate allocation types: The reserved traffic rate and the sustained traffic rate. Three service flows can be defined to support the WiMAX networks application. Constant bit rate (CBR), Variable bit rate (VBR) and Best Effort rate (BE). Based on the IEEE 802.16e 2005 standard, the WiMAX forum has broken these applications into five major classes as shown in table III.

Since the goal of this paper is to estimate the maximum capacity of typical Base Station (BS) and the effect of overhead over the capacity, we will focus of the minimum reserved data rate of each VBR and leave the maximum sustained data rate for other work. Table II defined the model for raw capacity estimation. Table III is the summarize application distribution assumption model which is the final distribution and will be taken into consideration in our bandwidth calculation algorithm.

C. Maximum user number per-base station algorithm

Fig. 3 show an algorithm to calculate the maximum number of users that can be simultaneously supported and maintained through a high throughput of networks.

TABLE II
 WiMAX CHANNEL BANDWIDTH SPREADSHEET MODEL

Item	Value	Units	Comments
Base Station	1	#	No. of BS
FFT size	512 1024	#	FFT configuration
Channel size	5 10	MHz	Channel size
Cyclic prefix	1/4,1/8,1/16,1/32	#	CP
N	28/27	#	Sampling factor
Fs	11.2	MHz	Sampling frequency
Tb	91.43	μs	Useful symbol time
Tg	11.43	μs	Guard time CP
Ts	102.86	μs	Symbol time (Tb +Tg)
Tf	5	ms	Frame duration
DL:UL	3:1	#	DL:UL ratio

TABLE III
 APPLICATION DISTRIBUTION ASSUMPTION

Application	Data rate (kbps)	Weight
Multiplayer interactive gaming.	50	25%
VOIP and video conference.	32	10%
Streaming media.	64	12.5%
Web browsing.	Normal	32.5%
Media content downloading	BE	20%

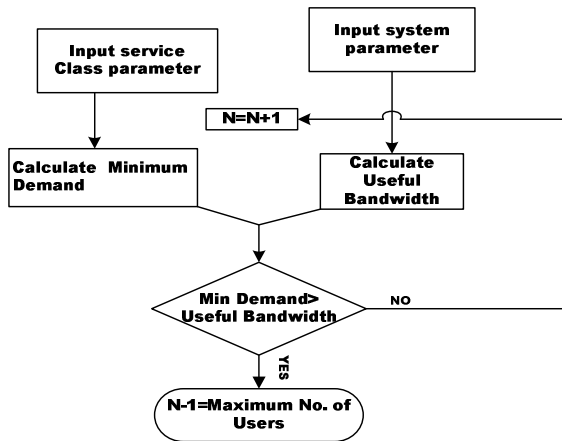

Fig. 3 maximum user number algorithms

IV. OVERHEAD ANALYSIS

In the DL subframe, overhead consists of a preamble, FCH, DL-MAP and UL-MAP as shown in Fig. 1. The MAP entries consist of a fixed part and a variable part. These entries can result in a significant amount of overhead.

WiMAX Forum recommends using compressed MAP, which reduces the DL-MAP entry overhead to 11 bytes and includes 4 bytes for Cyclic Redundancy Check (CRC). The fixed UL-MAP is 6 bytes long with an optional 4-byte CRC. With a repetition code of 4 and QPSK1/2, both fixed DL-MAP and UL-MAP take up 16 slots.

The variable part of DL-MAP consists of one entry per bursts and requires 60 bits per entry. Similarly, the variable part of UL-MAP consists of one entry per burst and requires 52 bits per entry. These are all repeated 4 times and use only QPSK1/2 MCS. It should be pointed out that repetition consists of repeating slots (and not bytes). Thus, both DL and UL MAPs entries also take up 16 slots each per burst. The UL subframe also has fixed and variable parts. Ranging and contention are in the fixed portion. Their sizes are defined by the network administrator.

The other fixed portion is channel quality indication (CQI) and acknowledgements (ACK). These regions are also defined by the network administrator. Obviously, more fixed portions are allocated; less number of slots are then available for the user workloads. In this analysis, three OFDM symbol columns for all fixed regions are allocated. Each UL burst begins with a UL preamble. One OFDM symbol is used for short preamble

and two for long preamble. One slot for the UL preamble is allocated. Each MAC PDU has at least 6-bytes of MAC header and a variable length payload consisting of a number of optional sub-headers, data, and an optional 4- byte CRC. The optional sub-headers include fragmentation, packing, and mesh. Each of these is 2 bytes long [1][8].

V. SIMULATION RESULTS AND ANALYSIS

An analysis has been performed to estimate the upper bound of the total number of simultaneous multi-traffic users. Figs. 4 and 5 show the maximum user's numbers of multi-traffic users with and without overheads while we use different MCS and AMC.

The range of the number of users when we use 5MHz channel bandwidth is from 4 to 79 and from 14 to 158 when we use 10MHz. The effect of overheads over BPSK and QPSK is more than other modulation and coding scheme, as show in figs. 4 and 5. This is because most of control message were sent by BPSK and QPSK.

Fig. 6 shows the number of users vs. data rate of each user with and without overheads. Fig. 7 shows the effect of overheads versus data rate of each user. With the increase in data rate of each user, the percentage effect of overheads decreases. This is because with the increase of data rate of each user, the numbers of users decrease. Thus the overheads decrease and throughput increases.

In fig. 8, the number of users increases with the growth of transmission power. According to equation (6), the radiuses of all regions increase with the growth of transmission power. Thus, the numbers of users increase. BS keeps accepting users until the minimum demand data-rate exceeds the amount of available BW.

Fig. 9 and 10 show the maximum number of users of multi-traffic users with and without overheads while (DL,UL) Modulation Coding Scheme (MCS) level are (QPSK1/2,QPSK1/2),(QPSK1/2,16QAM3/4),and(TMCS). When we use 5MHz channel bandwidth, we obtained 12 to 79 numbers of users and 42 to 205 users when we use 10MHz. This result may not be meaningful when QoS is considered in addition to the bandwidth requirement. This multi-traffic user's estimation contains real-time application, which is very sensitive to the delay. The delay increases when the user's number increases and the QoS will be affected. Therefore, an engineers' designer could use any way to control the user's number on the networks.

VI. CONCLUSION

Efficient and optimal utilization of available bandwidth resources has always been a matter of deep concern for engineers designing and implementing WiMAX networks. In this paper, we considered estimation of mobile WiMAX DL capacity and focused on the effect of overheads and different AMC.

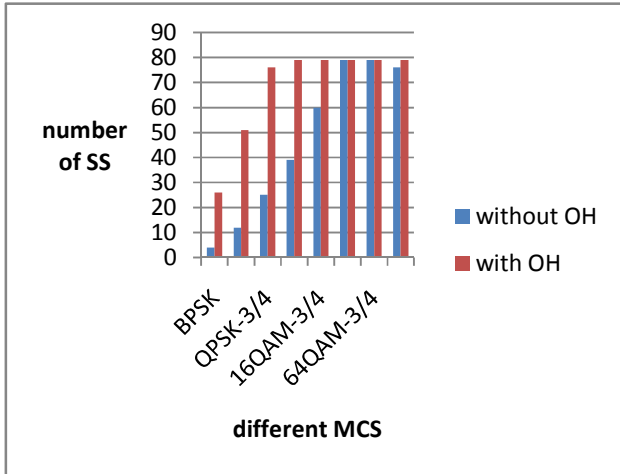

Fig. 4 number of users with different MCS (without and with overhead) 5MHz

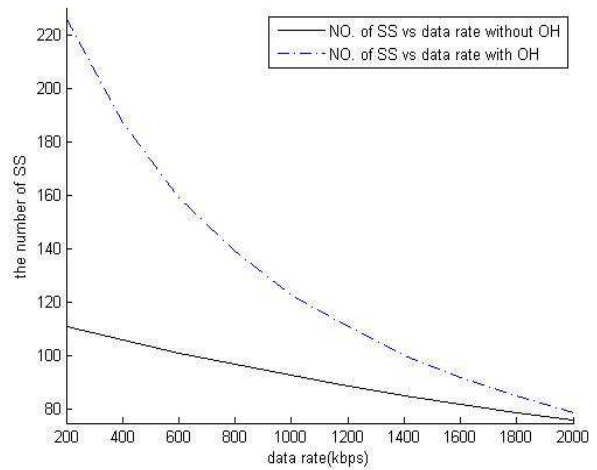

Fig. 6 No. of users versus data rate

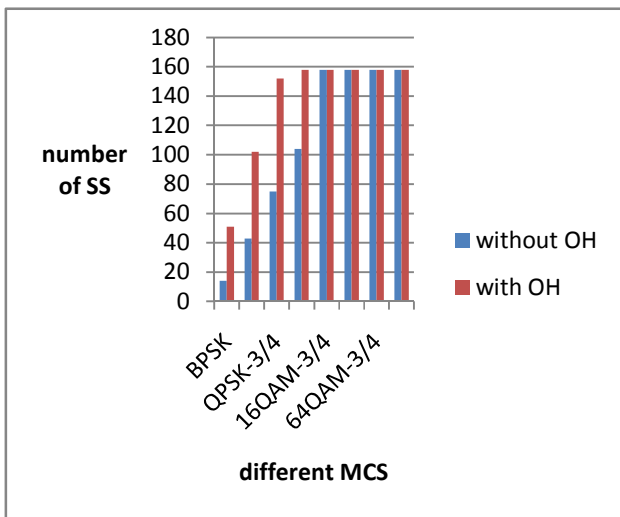

Fig. 5 number of users with different MCS (without and with overhead) 10MHz

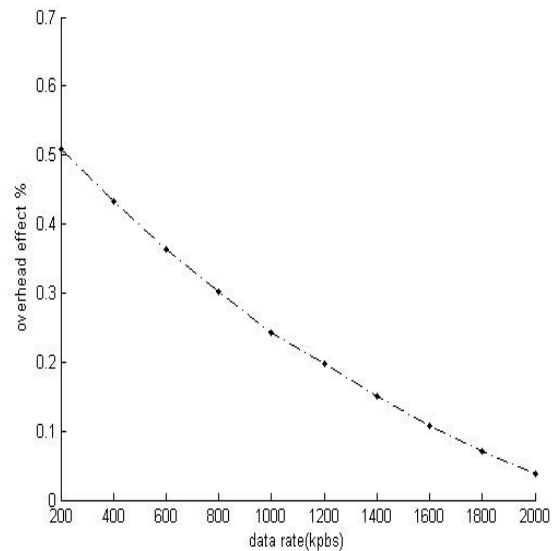

Fig. 7 The effect of overhead versus data rate

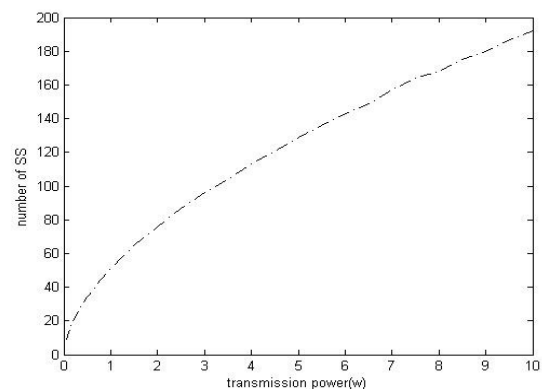

Fig. 8 No. of users versus transmission power

We calculated different regions radiuses with the COST-231Hata model. The algorithm for the calculation of the maximum number of users per BS is evaluated and the effect of overhead is estimated.

With the understanding of the system's raw capacity and the effect of the overheads associated with MAC and PHY layers on capacity of mobile WiMAX, we have discussed how the number of users is reduces when the data rate of user is increased. We also estimated how the number of users increases when the transmission power also increased. Overhead is one of the main factors that can affect the capacity of the network. The estimate showed the greatest effect of overhead is in BPSK and QPSK modulation.

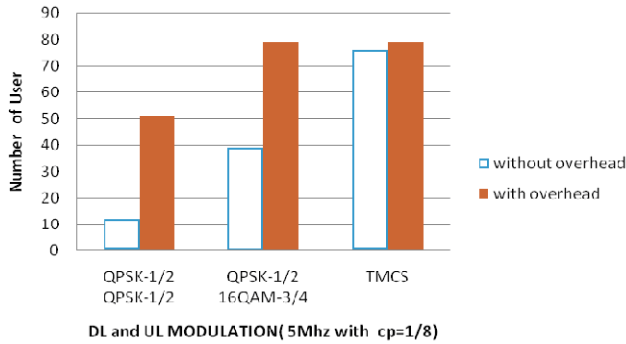

Fig. 9 Number of Users with Different MCS(without and with overhead)5MHz

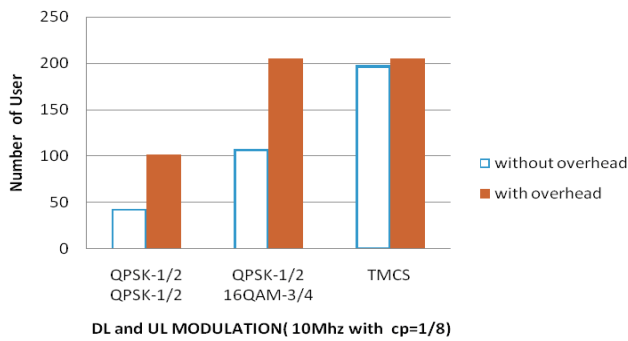

Fig. 10 Number of Users with Different MCS(without and with overhead) 10MHz

REFERENCE

- [1] Chakchai So-In, Raj Jain, Abdel-Karim Al Tamimi, "Capacity Estimation of IEEE 802.16e Mobile WiMAX Networks", Journal of Computer Systems, Networks, and Communications, Vol. 1, No. 1, April 2010.
- [2] Loutfi Nuaymi, "WiMAX: Technology for Broadband Wireless Access", John Wiley & Sons. Section 5-4, 2007.
- [3] A. Belghith and L. Nuaymi, "WiMAX capacity estimations and simulation results," IEEE Vehicular Technology Conference, 2008..
- [4] Shamik Sengupta, Mainak Chatterjee, and Samrat Ganguly. "Improving Quality ofVoIP Streams over WiMAX". IEEE transactions on computers, vol. 57, no. 2, February 2008, pp 145 -156.
- [5] C. Tarhini and T. Chahed, "On capacity of OFDMA-based IEEE802.16 WiMAX including Adaptive Modulation and Coding (AMC) and inter-cell interference," 15th IEEE Workshop on Local & Metropolitan Area Networks, 2007.
- [6] H. R. Anderson, Fixed Broadband Wireless System Design. John Wiley, 2003.
- [7] D. Lois and T. Scelles "WiMAX Network Quality of Service," ATDI White Paper- June2005. http://www.atdi.com/docs/wp_WiMAX_traffic_analysis_eng.pdf
- [8] WiMAXTM System Evaluation Methodology ,WiMAX Forum, Version 2.1, pp 198, July 7, 2008.
- [9] D. Sweeney, WiMAX Operator's Manual, Apress, 2004.
- [10] P. Piggin, WiMAX in Depth: Broadband wireless access, IEEE Communications Engineer Vol. 2, Issue 5, Oct. 2004, Page(s):36-39.