

Optimization Parameters of Rotary Positioner Controller using CDM

Meemongkol A., Tipsuwanporn V. and Numsomran A.

Abstract— The authors present optimization parameters of rotary positioner controller in hard disk drive servo track writing process using coefficient diagram method; CDM. Due to estimation parameters in PI Positioning Control System by expected ratio method cannot meet the required specification of response effectively, we suggest coefficient diagram method for defining controller parameters under the requirement of the system. Finally, the simulation results show that our proposed method can improve the problem in tuning parameter of rotary positioner controller. It is satisfied specification of performance of control system. Furthermore, it is very convenient as a fast adjustment damping ratio as well as a high speed response.

Keywords—Optimization Parameters, Rotary Positioner, CDM

I. INTRODUCTION

Rotary positioner control system in No Clock Head servo track writer control the product actuator during the servo write process by PI controller which is configured to suit various specifications by setting controller parameters.

Problem that occurred with the parameters adjustment in PI Positioning Control System of Rotary Positioner is estimating them from the related ratio that recommended by user manual [1] cannot meet the desired specification response. Due to the relation of parameters in control system, tuning them formlessly cannot meet the required specification of response and causes time wasting. This paper proposes optimization the parameters of PI Rotary Positioner Control System using Coefficient Diagram Method which is satisfied specification of performance of control system. Furthermore, it is very convenient as a fast adjustment damping ratio as well as a high speed response.

The details of our proposed method and experiment are described clearly as the following topic. In section 2 has the detail of Position control of rotary Positioner in servo track writing process. In section 3 explains the detail of Coefficient Diagram Method. In section 4 describes the detail of Numerical Experiment. In section 5 has the detail of

Memongkol A. is with the Faculty of Engineering, Instrumentation Engineering, King Mongkut's Institute of Technology Ladkrabang, Bangkok, Thailand.

Tipsuwanporn V. is with the Faculty of Engineering, Instrumentation Engineering, King Mongkut's Institute of Technology Ladkrabang, Bangkok, Thailand., Phone: 661-9250356; Email: ktvittay@kmitl.ac.th

Numsomran A. is with the Faculty of Engineering, Instrumentation Engineering, King Mongkut's Institute of Technology Ladkrabang, Bangkok, Thailand., Phone: 661-9250356; Email: knarjin@kmitl.ac.th

Simulation & Results and the conclusion is explained in section 6.

II. POSITION CONTROL OF ROTARY POSITIONER IN SERVO TRACK WRITING PROCESS

A. Rotary Positioner Control System

Rotary Positioner Control System is one of the most important parts of conventional servo track writer. It is used to control the product actuator during the servo write process. In Figure 1 shows structure of one cell servo track writer experimental equipment that consists of the first part as personal computer (PC). It executes test code for monitor and controls all procedures in servo track writing process. The second part is block of control/driver and interface card which consist of radial card, R/W motor card, clock pattern card and DE IF card.

The third significant part is the part of positioning control in rotary positioner control system which plays a crucial role as it carries out the positioning of R/W head. It consists of rotary positioner (Motor/Encoder KP-1M) and positioner control card (System Controller : SC-01H/PC) which receives commands and the value of positioning control parameters from PC in the form of execute software. Then the positioning control are controlled by an on-board DSP, which runs its own task to generate the suitable control signal and send the signal to drive circuit and rotary positioner respectively.

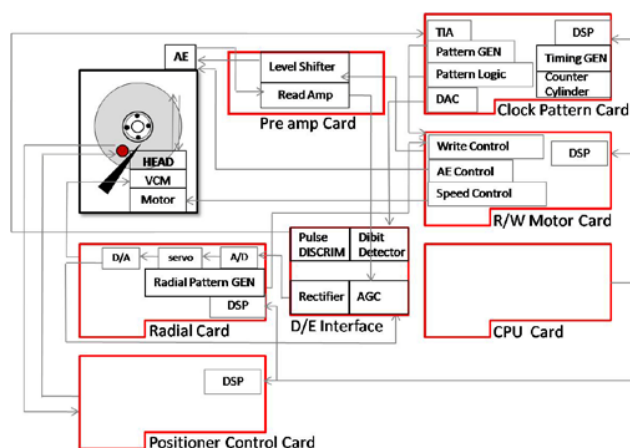

Fig. 1. Block Diagram of One Cell Tester

B. Parameters of Rotary Positioner Control System

This section describes the parameters which are used in this rotary positioner system. The rotary positioner system can be

configured to suit various specifications by setting parameters. The parameters are sent to the rotary positioner from the host computer via the interface.



Fig. 2. STW One Cell Test Bench

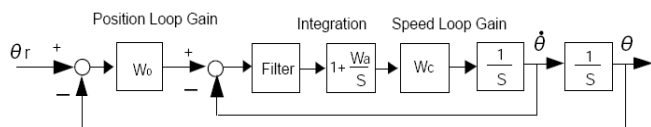

Fig. 3 Schematic of PI Positioning Control System

Control system's block diagram is showed in Fig. 3. Because the servo system consists of digital sub-systems, it is a discrete system. However, so the servo system can be regarded as a continuous system.

The functions of parameters from the viewpoint of the servo system as a continuous system are individually described in the following

W_o : Position Loop Gain [rad/second]

This parameter is used to determine the response of the position control loop. Generally, the position loop gain W_o is set to a value less than one-fourth of the Speed Loop Gain.

W_c : Speed Loop Gain [rad/sec]

This parameter, which determines the response of the speed control loop, is normally set to a value at least four times the Position Loop Gain. The higher the speed loop gain, the greater the servo stiffness. It is thus desirable to set as high a speed loop gain value as possible, but setting it too high will affect the resonant frequency point of the mechanical system and cause hunting to occur in the servo system. Therefore, set the Speed Loop Gain to the maximum value at which no hunting occurs.

W_a : Integration Constant [rad/sec]

Similar to speed loop gain, this parameter also greatly affects the servo stiffness. The higher the integration constant, the greater the servo stiffness, setting this value too high, however, will adversely affect the stability of the servo system and cause hunting to occur. The Integration Constant is normally set to a value about one-third of the Speed Loop Gain.

W_f : Filter Constant [rad/sec]

This parameter fixes cut off frequency of low pass filter. A typical value for this parameter is four times as large as the speed loop gain. The lower the cut-off frequency W_f is, the smaller the noise in the system becomes. Setting W_f too low, however, affects the system stability and requires longer setting time.

C. Problems with parameter tuning of Rotary Positioner Controller

Problem that occurred with the parameters adjustment in PI Positioning Control System of Rotary Positioner is estimating them from the related ratio that recommended by user manual cannot meet the desired position response.

Due to the relation of parameters in control system, tuning them formlessly cannot meet the required specification of response and causes time wasting.

This paper proposes optimization the parameters of PI Rotary Positioner Control System using Coefficient Diagram Method which is satisfied specification of performance of control system. Furthermore, it is very convenient as a fast adjustment damping ratio as well as a high speed response.

III. COEFFICIENT DIAGRAM METHOD

The CDM [2], [3] is used for design the controller so that the step response of the controlled system satisfies both transient and steady state response specifications, and also satisfies the requirements of stability, faster response and robustness.

Coefficient Diagram is used for investigating the stability, time response and robustness characteristics of systems in a single diagram, which is important for systems with large characteristic polynomial degree.

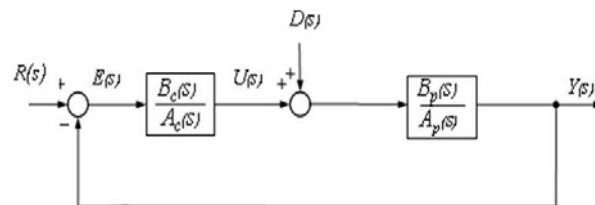

Fig. 4 A block diagram of CDM control system.

The block diagram of CDM design for a single input-single output (SISO) system is shown in Fig 4. Here $Y(s)$ is the output signal, $R(s)$ is the reference input, $D(s)$ is the disturbance. $B_p(s)$ and $A_p(s)$ are numerator and denominator of transfer function of the plant, respectively. $B_c(s)$ and $A_c(s)$ are numerator and denominator of transfer function of the controller transfer function.

The polynomials form of the controller and the plant are generally be written respectively in the form [4].

$$A_c(s) = l_\lambda s^\lambda + l_{\lambda-1} s^{\lambda-1} + \dots + l_0 \quad (1)$$

$$B_c(s) = k_\lambda s^\lambda + k_{\lambda-1} s^{\lambda-1} + \dots + k_0 \quad (2)$$

and

$$A_p(s) = P_k s^k + P_{k-1} s^{k-1} + \dots + P_0 \quad (3)$$

$$B_p(s) = q_m s^m + q_{m-1} s^{m-1} + \dots + q_0 \quad (4)$$

where $\lambda < k$ and $m < k$

When we neglect the effect by disturbance $D(s)$, closed loop transfer function become $G_{cl}(s)$ in eq. (5).

$$G_{cl}(s) = \frac{Y(s)}{R(s)} = \frac{B_p(s)}{A_c(s)A_p(s) + B_c(s)B_p(s)} \quad (5)$$

the characteristic polynomial and given by

$$P(s) = a_n s^n + a_{n-1} s^{n-1} + \dots + a_1 s + a_0 \quad (6)$$

$$= \sum_{i=0}^n a_i s^i$$

where a_0, a_1, \dots, a_n are the real coefficients.

The stability index γ_i the equivalent time constant τ and the stability limit γ_i^* are defined as follows:

$$\gamma_i = \frac{a_i^2}{a_{i+1} a_{i-1}}, i = 1, \dots, n-1, \gamma_0 = \gamma_n = \infty \quad (7)$$

$$\tau = \frac{a_1}{a_0} \quad (8)$$

$$\gamma_i^* = \frac{1}{\gamma_{i+1}} + \frac{1}{\gamma_{i-1}} \quad (9)$$

From Eq. (6) - (8), the coefficients a_i and the characteristic equation $P(s)$ are

$$a_i = a_0 \tau^i \frac{1}{\gamma_{i-1} \dots \gamma_2 \gamma_1^{i-1}} = a_0 \tau^i \prod_{j=1}^{i-1} \frac{1}{(\gamma_{i-j})^j} \quad (10)$$

$$P(s) = a_0 \left\{ \sum_{i=2}^n \left(\prod_{j=1}^{i-1} \frac{1}{\gamma_{i-j}^j} \right) (\tau s)^i + \tau s + 1 \right\}, \quad (11)$$

The coefficients in Eq. (5) came from the chosen stability index γ_i and equivalent time constant τ by equating the $P(s)$ of Eq. (5) with the characteristic equation of Rotary Positioner control system, such that the parameters of PI controller are obtained.

IV. CONTROLLER DESIGN FOR THE ROTARY POSITIONER SYSTEM

In this section, the design procedures of PI Controller via CDM.

where PI Controller transfer function is Eq. (12)

$$G_c(s) = \frac{W_c s + W_o W_a}{s} \quad (12)$$

Rotary Positioner closed loop system transfer function is expressed as below.

$$G_{cl}(s) = \frac{W_o \cdot s + W_o \cdot W_a \cdot W_c}{T_f s^4 + s^3 + W_c s^2 + (W_a \cdot W_c + W_o \cdot W_c) s + W_o \cdot W_a \cdot W_c} \quad (13)$$

The equivalent time constant τ is chosen as $\tau = t_s / 2.58$ where t_s is the specified settling time.

Stability indices for Rotary Positioner system came from the best value that gave best simulation results. It is different from standard form [4] but still achieve the desired characteristics for the controller

Stability index $\gamma_1 = 4, \gamma_2 = 1.4286, \gamma_3 = 5$

The stability limits are computed from Eq.9 to be

$$\gamma_i^* = [0.699 \quad 0.45 \quad 0.699]; i = 1 \sim 3, \gamma_0, \gamma_4 = \infty$$

the $P(s)$ can be expressed as

$$P(s) = a_4 s^4 + a_3 s^3 + a_2 s^2 + a_1 s + a_0, \quad (14)$$

where

$$a_i = \frac{a_0 \tau^i}{(\gamma_{i-1} \gamma_{i-2} \dots \gamma_2^{i-2} \gamma_1^{i-1})},$$

and characteristic equation of closed loop transfer function is

$$P_{cl}(s) = T_f s^4 + s^3 + W_c s^2 + (W_a \cdot W_c + W_o \cdot W_c) s + W_o \cdot W_a \cdot W_c \quad (15)$$

Equated the above $P(s)$ to the $P_{cl}(s)$ of the plant in Eq. (15), the parameters of PI controller are obtained as Eq. (16)~(17).

$$W_c = \frac{\gamma_1 \cdot \gamma_2}{\tau} \quad (16)$$

$$W_a = \frac{\gamma_1 - W_o \tau}{\tau} \quad (17)$$

V. SIMULATION & RESULTS

In this paper, the simulation results of rotary positioner positioning control is given by MATLAB Simulink program. The simulation in Fig. 4 illustrates optimization of PI controller's parameters using Coefficient Diagram Method which is satisfied specification of performance of control system and explain about adjustment of response speed and its overshoot by CDM technique.

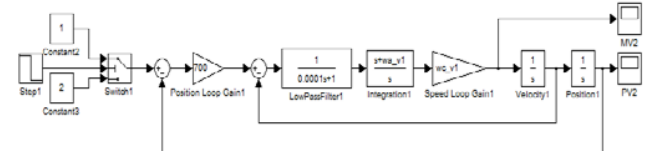

Fig. 4 Simulation System

Plant Parameters was shown in Table I.

TABLE I
Rotary Positioner Plant Parameters

Symbol	Description	Quantity
T_f	1/Cut off frequency	0.0001 [sec/rad]
W_o	Position Loop Gain	700 [rad/sec]
W_a	Speed Loop Gain	$(\gamma_1 - W_o \tau) / \tau$
W_c	Integration Constant	$\gamma_1 \cdot \gamma_2 / \tau$

From this data formed by Eq. (15) then it is obtained the characteristic equation of closed loop transfer function as

$$P_{cl}(s) = 1e - 3s^4 + s^3 + W_c s^2 + (W_a \cdot W_c + 700 \cdot W_c) s + 700 \cdot W_a \cdot W_c \quad (18)$$

According to Eq. (14), design of PI controller based on CDM, is assigned parameter follow as time constant $\tau = 0.0029$. The stability index $\gamma_1 = 4, \gamma_2 = 1.4286, \gamma_3 = 5$ then the characteristic equation is,

$$P(s) = (1e - 3) s^4 + (9.99e - 1) s^3 + (1.97e + 3) s^2 + (2.71e + 6) s + 9.36e + 8 \quad (19)$$

Equated the above $P_{cl}(s)$ in Eq. (18) to the $P(s)$ of the plant with the PI controller in Eq. (19), the parameters of PI controller are

$$W_c = 1970.50, W_a = 679.31$$

The step response in Fig.5, showed the response's overshoot which is over 0 percent and settling time is at 0.0065 msec.

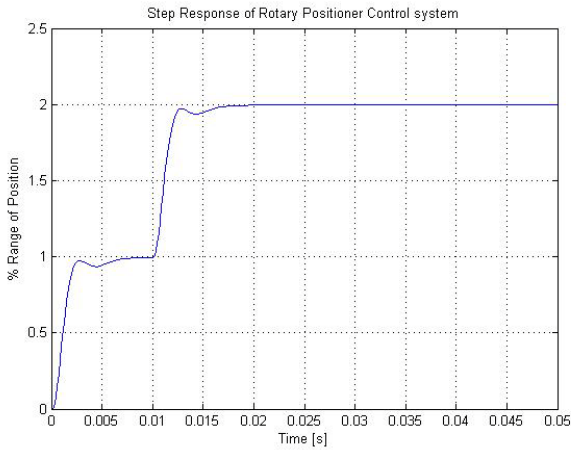

Fig. 5. Step Response of Rotary Positioner Control System

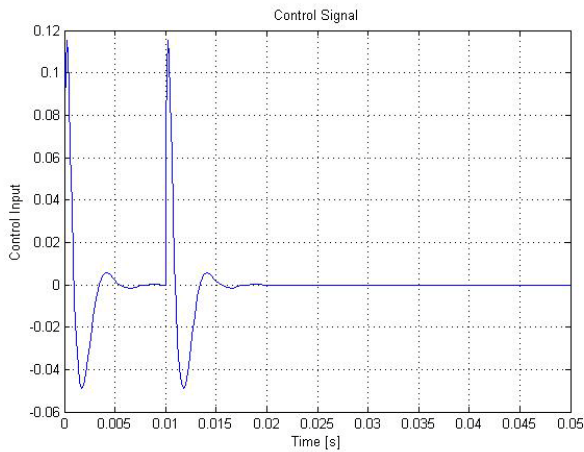

Fig. 6. Control Signal of Controller

Adjustment speed response by using CDM method for optimization of PI controller's parameters are described as follow details

The characteristic equation is,

$$P(s) = (1e-3)s^4 + (9.99e-1)ks^3 + (1.97e+3)k^2s^2 + (2.71e+6)k^3s + (9.36e+8)k^4 \quad (20)$$

where k are 0.7, 1, 3 respectively.

Assign parameter follow as time constant $\tau=0.0029$,.The stability index $\gamma_1 = 4, \gamma_2 = 1.4286, \gamma_3 = 5$.

Equated the above $P_{cl}(s)$ in Eq. (18) to the $P(s)$ of the plant with the PI controller in Eq. (20), and the parameter of PI controller are given as shown in table II.

Fig 7 shows that, when k is adjusted, setting time is decreased from 0.0085 sec. to 0.0065 sec. to 0.0057 sec. therefore; the system response is faster.

TABLE II
 Controller Parameters

k	W_c	W_a
0.7	1379.30	265.51
1	1970.50	679.31
3	5911.40	3437.90

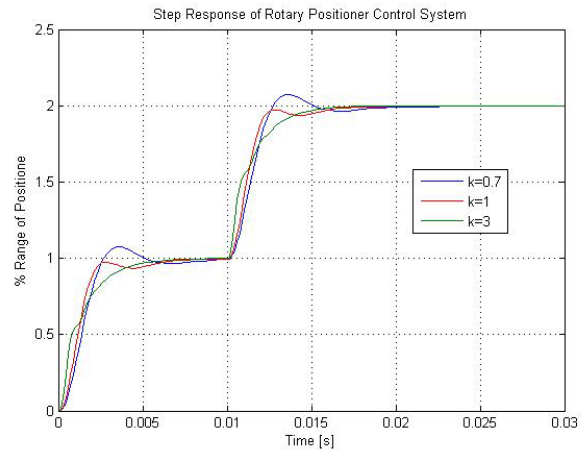

Fig. 7. Speed Adjustment of Step Response of Rotary Positioner Control System

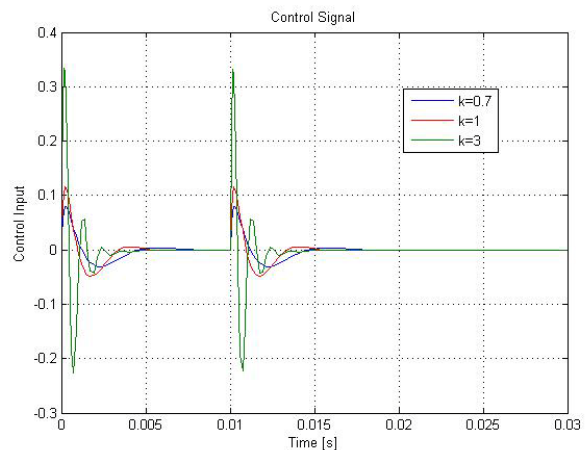

Fig. 8. Control Signal of Controller

Adjustment overshoot of response by using CDM method for optimization of PI controller's parameters are described as follow details

The characteristic equation is,

$$P(s) = (1e-3)s^4 + (9.99e-1)k^3s^3 + (1.97e+3)k^5s^2 + (2.71e+6)k^6s + (9.36e+8)k^6 \quad (21)$$

where k are 0.85, 1, 1.5 respectively.

Equated the above $P_{cl}(s)$ in Eq. (18) to the $P(s)$ of the plant with the PI controller in Eq. (21), then the parameter of PI controller are given as shown in table III.

TABLE III
 Controller Parameters

k	W_c	W_a
0.85	1423.70	472.41
1	1970.50	679.31
1.5	4433.60	1369.00

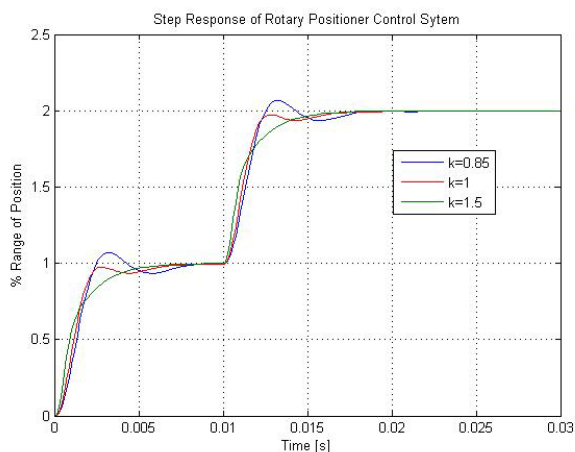

Fig. 9. Overshoot Adjustment of Step Response of Rotary Positioner Control System

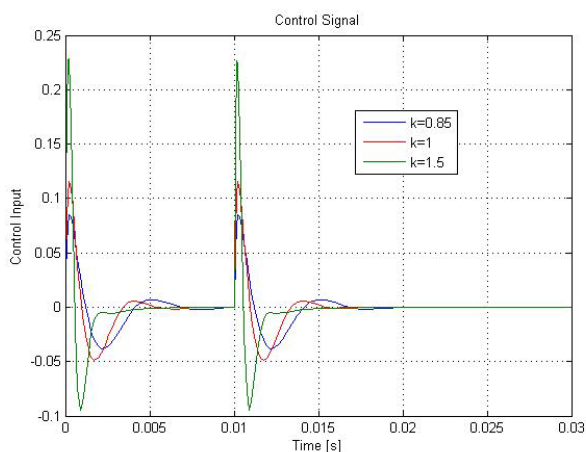

Fig. 10. Control Signal of Controller

Fig 9 shows the step response, when k is changed 0.85 to 1 and 1.5 respectively then the damping ratio is also increased but the overshoot is decreased from 3.24 percent to 0%.

As shown simulation results, we can conclude that Coefficient Diagram Method can be used for optimization the parameters of PI Rotary Positioner Control System and satisfy specification of performance of control system. Furthermore, it is very convenient as a fast adjustment damping ratio as well as a high speed response.

VI. CONCLUSION

In this paper, optimization the parameters of PI Rotary Positioner Control System using Coefficient Diagram Method is presented. The simulation results from MATLAB are able to

illustrate that CDM Techniques can be applied to Positioning Control System of Rotary Positioner for solving the problem in tuning controller parameters. Its advantage which only one parameter is to be adjusted, speed and overshoot response is changed and satisfied the required response specification.

ACKNOWLEDGMENT

The author would like to acknowledge his sincere thank to the Industry/University Cooperative Research Center in Data Storage Technology and Application, King Mongkut's Institute of Technology Ladkrabang and National Electronics and Computer Technology Center, National Science and Technology Development Agency.

REFERENCES

- [1] Canon Rotary Positioning System Operation Manual, Software Version: pms1.5
- [2] K. Saito, K. Muta and S. Manabe, "A solution of the Benchmark problem by coefficient diagram method", ACC95-AIAA-20,1995.
- [3] S. Manabe and Y.C. Kim, "Recent development of Coefficient Diagram Method", ASSC'2000 3rd Asian Control conference, Shanghai, 2000.
- [4] S. Manabe, "Coefficient Diagram Method", 14th IFAC Symposium on Automatic Control in Aerospace, Seoul Aug 1998.
- [5] Y. C. Kim, L. H. Keel and S. P. Bhattacharyya, "Transient Response Control via Characteristic Ratio Assignment", *IEEE Transactions On Automatic Control*, Vol.48, No.12, pp.2238-2244, 2003
- [6] Yamaguchi, T., "HDD servo control development - Present and future", SICE-ICASE, 2006. International Joint Conference Volume , Issue , 18-21 Oct. 2006 Page(s):2756 – 2759
- [7] Ben M. Chen, Tong H. Lee, Kemao Peng and Venkatakrishnan Venkataramanan, "Hard Disk Drive Servo Systems", 2nd Edition, Springer