

Generalized Predictive Control of Batch Polymerization Reactor

R. Khaniki, M.B. Menhaj, H. Eliasi

Abstract—This paper describes the application of a model predictive controller to the problem of batch reactor temperature control. Although a great deal of work has been done to improve reactor throughput using batch sequence control, the control of the actual reactor temperature remains a difficult problem for many operators of these processes. Temperature control is important as many chemical reactions are sensitive to temperature for formation of desired products. This controller consist of two part (1) a nonlinear control method GLC (Global Linearizing Control) to create a linear model of system and (2) a Model predictive controller used to obtain optimal input control sequence. The temperature of reactor is tuned to track a predetermined temperature trajectory that applied to the batch reactor. To do so two input signals, electrical powers and the flow of coolant in the coil are used. Simulation results show that the proposed controller has a remarkable performance for tracking reference trajectory while at the same time it is robust against noise imposed to system output.

Keywords—Generalized Predictive Control (GPC), Temperature Control, Global Linearizing Control (GLC), Batch Reactor.

I. INTRODUCTION

POLYMERIZATION reactors play a key role in polymer engineering and the importance of their effective control is well-recognized in the polymerization literature [1, 2, and 3]. A major characteristic of polymerization reactors is their complex nonlinear behavior [2, 4].

During the eighties, significant advances were made in the area of nonlinear control, primarily within the differential geometric framework. Not only the system theoretic properties of nonlinear system are now well-understood [5, 6], but also controller design technique are available, like the Globally Linearizing Control (GLC) method [7, 8]. The GLC method with a PI linear controller has been used by M.Soroush and C.Kravaris in [13] for nonlinear control of a batch polymerization reactor.

In this paper we use GLC and MPC methods to control the temperature of a batch polymerization reactor in which solution of poly-methyl-methacrylate (PMMA) polymerization takes place. The rest of this paper is as follows: The description of Mathematical model, after a brief review of the GLC design method, followed by a brief review of MPC method and finally application control method to batch reactor system.

R. Khaniki is with the Department of Electrical Eng and Robotics, Shahrood university of Technology, Shahrood, Iran. e-mail: ro_hmm@yahoo.com

M.B. Menhaj and H. Eliasi is with the Department of Electrical Engineering, Amirkabir university of Technology, Tehran, Iran

II. MATHEMATICAL MODEL

The GLC is a model-based control method; therefore, a mathematical description of the process (in state-space form) is needed to synthesize the control law. Figure 1 shows the schematic diagram of batch reactor.

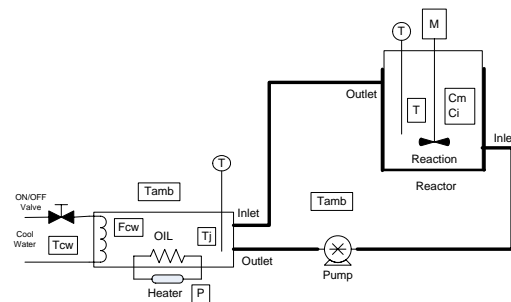

Fig. 1 Schematic Diagram of the Batch Polymerization Reactor

A. Reactor and Jacket Dynamics

Species balances for the monomer, initiator, solvent and dead polymer for the reactor and energy balances for the reactor and jacket, under standard assumptions, the reactor and jacket dynamics [9] are given as follow:

$$\begin{cases} \frac{dC_m}{dt} = f_1(C_m, C_i, T) \\ \frac{dC_i}{dt} = f_2(C_m, C_i, T) \\ \frac{dT}{dt} = f_3(C_m, C_i, T, T_j) \\ \frac{dT_j}{dt} = f_4(C_m, T, T_j) + \alpha_4 u \end{cases} \quad (1)$$

where:

$$u = P - \frac{\alpha_5 (F_{cw})}{\alpha_4} (T_j - T_{cw}) \quad (2)$$

u is the net heat input to the jacket by the heater and inlet cooling water. f_1, f_2, f_3, f_4 are scalar functions (see [9] for details); for brevity, these are not gives here. α_4 is a constant parameter.

B. Control Problem

The control problem is to force the reactor to follow the optimal temperature profile $T^*(t)$ (shown in Fig. 2) by using the nonlinear control method and model predictive controller.

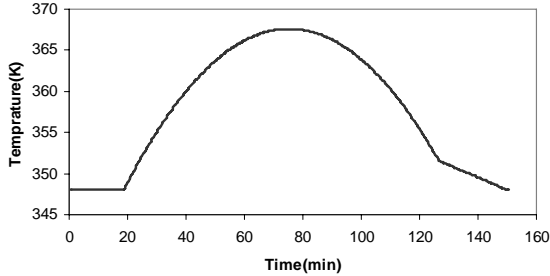

Fig. 2 Temperature Profile

III. THE GLC METHOD

A. A Brief Review

The GLC structure [7, 8] (depicted in Fig.3) consists of (a) a static state feedback (in inner loop), under which the closed-loop input/output system is exactly linear, and (b) an external linear controller (in outer loop) to ensure offset-less tracking of set point in the presence of modeling errors and process disturbances.

In the case the state variables are not measured on-line, they should be reconstructed by using state observers (Fig. 4) [10]. In what follows, a brief review of the GLC synthesis approach will be provided.

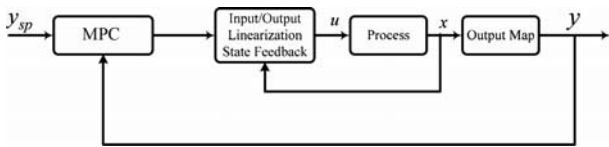

Fig.3: The GLC structure

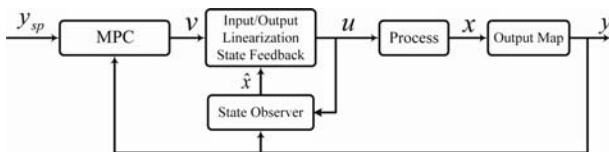

Fig.4: The GLC-output feedback structure

Consider SISO processes which are described by a model of the form:

$$\begin{cases} \dot{x} = f(x) + g(x)u \\ y = h(x) \end{cases} \quad (3)$$

With a finite relative order r (the relative order r is smallest integer for which $L_g L_f^{r-1} h(X) \neq 0$). Here $x \in \mathfrak{R}^n$ is the vector of state variables, $u \in \mathfrak{R}$ and $y \in \mathfrak{R}$ are the manipulated input and the controlled output, respectively.

$f(x)$ and $g(x)$ are analytic vector functions, and $h(x)$ is an analytic scalar function.

For the system of the form of Eq.3, the state feedback of the GLC has the form:

$$u = \frac{v - h(x) - \sum_{l=1}^r \beta_l L_f^l h(x)}{\beta_r L_g L_f^{r-1} h(x)} \quad (4)$$

where β_l s are tunable parameters. And v is the output of the external controller. Under the state feedback of Eq.4, the input/output behavior of the closed-loop ($v - y$) system is linear without zeros:

$$y + \sum_{l=1}^r \beta_l \frac{d^l y}{dt^l} = v \quad (5)$$

For control problems that involve constant set points, the bias of the external controller is normally taken to be constant. In batch processes, however, where the objective is to track an a priori known smooth time-varying set-point profile $y_{sp}(t)$, controller performance is greatly improved by using a time-varying bias for the external controller. The bias will naturally arise, if Eq.5 is recast in deviation variable form:

$$y' + \sum_{l=1}^r \beta_l \frac{d^l y'}{dt^l} = v' \quad (6)$$

where:

$$y' = y - y_{sp}$$

$$v' = v - \left(y_{sp} + \sum_{l=1}^r \beta_l \frac{d^l y_{sp}}{dt^l} \right)$$

and then an external bias-free error feedback controller (e.g. with transfer function $G_e(s)$ such that $1/G_e(0) = 0$) is used:

$$v'(t) = \int_0^t G_e(t - \tau) e(\tau) d\tau$$

or equivalently:

$$v(t) = v_b(t) + \int_0^t G_e(t - \tau) e(\tau) d\tau \quad (7)$$

where:

$$v_b(t) = y_{sp}(t) + \sum_{l=1}^r \beta_l \cdot \frac{d^l y_{sp}}{dt^l} \quad (8)$$

is the external controller bias.

B. Synthesis Of The Control Law

The nonlinear control law is synthesized by following the steps of the GLC method, i.e.:

- 1) Recasting the model described by Eq.1 in the standard state-space form of Eq.3:

$$\begin{cases} \frac{d}{dt} \begin{bmatrix} C_m \\ C_i \\ T \\ T_j \end{bmatrix} = \begin{bmatrix} f_1(C_m, C_i, T) \\ f_2(C_m, C_i, T) \\ f_3(C_m, C_i, T, T_j) \\ f_4(C_m, T, T_j) \end{bmatrix} + \begin{bmatrix} 0 \\ 0 \\ 0 \\ \alpha_4 \end{bmatrix} u \\ y = T \end{cases}$$

Here $x = [C_m \ C_i \ T \ T_j]^T \in \mathbb{R}^4$.

- 2) Calculating the relative order :
 $r = 2 (L_g L_f h = \alpha_1 \cdot \alpha_4 \neq 0, L_g h = 0)$
- 3) Calculating the state feedback:

$$u = \frac{v - \beta_2 \sum_{i=1}^4 \frac{\partial f_3(x)}{\partial X_i} f_i(x) - \beta_1 \cdot f_3(x) - T}{\beta_2 \cdot \alpha_1 \cdot \alpha_4} \quad (9)$$

where β_1 and β_2 are tunable parameter.

- 4) As an external linear controller, using GPC controller.

Once the value of u calculated by the control law the corresponding values of the two actual manipulated inputs (P, F_{cw}), are calculated according to the same coordination rules.

$$P = \begin{cases} u & 0 < u < P_{\max} \\ P_{\max} & u > P_{\max} \\ u + \frac{\alpha_5}{\alpha_4} (T_j - T_{cw}) & -\frac{\alpha_5}{\alpha_4} (T_j - T_{cw}) < u < 0 \\ 0 & u < -\frac{\alpha_5}{\alpha_4} (T_j - T_{cw}) \end{cases}$$

$$\alpha_5(F_{cw}) = \begin{cases} \alpha_5 & u < 0 \\ 0 & u > 0 \end{cases}$$

C. Reduced Order State Observer

In the state feedback (Eq.9), u is a function of the four states C_m, C_i, T and T_j . From these four states, C_m, C_i are not measured on-line, therefore, they should be estimated. A reduced-order observer is used to estimate the concentrations of the monomer and initiator. For the model of Eq.1 this involves on-line integration of the first two differential equation of the model, i.e.:

$$\begin{cases} \frac{d\hat{C}_m}{dt} = f_1(\hat{C}_m, \hat{C}_i, T), & \hat{C}_m(0) = C_m \\ \frac{d\hat{C}_i}{dt} = f_2(\hat{C}_m, \hat{C}_i, T), & \hat{C}_i(0) = C_i \end{cases}$$

where the \hat{C}_m and \hat{C}_i denotes the estimates of the concentrations C_m and C_i , using the measured reactor temperature as input.

IV. MODEL PREDICTIVE CONTROL

Model Predictive Control (MPC) originated in the late seventies and has developed considerably since then.

MPC is an optimization-based multivariable control strategy that uses a mathematical model, incorporated into a control system, to predict in real-time the control action to be taken on the process. The predictive model represents the relationship between the process inputs and the process outputs. The MPC has the ability to predict process behavior and proactively take measures to optimize control.

Predictive control determines future values of the manipulated variable by optimizing a cost function, which expresses the control objectives and constraints.

As it were, at the present time t , the present and future control inputs on the control horizon $N_u, u(t), u(t+1), \dots, u(t+M-1)$ and predicted outputs over the prediction horizon $N, \hat{y}(t), \hat{y}(t+1), \dots, \hat{y}(t+N)$ are obtained by solving an optimization problem represented by a specified objective function. Among these solutions, only the first input $u_d(t)$ is implemented for time $(t, t+1)$. At the next time step, new values of the measured output are acquired, the control and prediction horizons are shifted forward by one step and the same calculations are repeated.

To compensate the modeling error, new measurements have to be done at each time step.

A general objective function is the following quadratic form, mostly referred to as generalized predictive control (GPC) [11]:

$$J(N_1, N_2, N_u) = \sum_{j=N_1}^{N_2} \delta(j) [\hat{y}(t+j) - \dots - w(t+j)]^2 + \sum_{j=1}^{N_u} \lambda(j) [\Delta u(t+j-1)]^2 \quad (10)$$

where $\hat{y}(t + j/t)$ is an optimum j step ahead prediction of the system output on data up to time t , N_1 and N_2 are the minimum and maximum costing horizons, N_u is the control horizon, $\delta(j)$ and $\lambda(j)$ are weighting sequences and $w(t + j)$ is the future reference trajectory. For simplicity we can assume that $\lambda(j) = \lambda$, $\delta(j) = 1$.

The objective of predictive control is to compute the future control sequence $u(t), u(t+1), \dots, u(t+N_u)$ in such a way that the future plant output $y(t+j)$ is driven closed to $w(t+j)$. This is accomplished by minimizing $J(N_1, N_2, N_u)$.

The process to be controlled is described by following model:

$$A(q^{-1})y(t) = B(q^{-1})u(t-1) + e(t) \quad (11)$$

This model is CARIMA model. In this model $y(t)$ is reactor temperature, $u(t)$ is the net heat input to the jacket, $e(t)$ a random noise sequence that models the error between output plant and output model and q^{-1} is the backward shift operator. $A(q^{-1})$ and $B(q^{-1})$ are polynomials as a function of the backward shift operator, q^{-1} . Their order are n_a and n_b , respectively.

We use this model to predict output over prediction horizon. To derive j -step-ahead predictor of $\hat{y}(t+j)$ based on the (Eq.11), consider the Diophantine equation. Then a set of N_2 j -step-ahead outputs prediction over prediction horizon expressed as:

$$\hat{Y} = G\Delta U + F \quad (12)$$

Where:

$$\hat{Y} = [\hat{y}(t+1/t)\hat{y}(t+2/t)\dots\hat{y}(t+N/t)]^T$$

$$\Delta U = [\Delta u(t)\Delta u(t+1)\dots\Delta u(t+N-1)]^T$$

$F = [f_1 f_2 \dots f_N]^T$ is free response of system.

$$G = \begin{bmatrix} g_0 & 0 & \dots & 0 \\ g_1 & g_0 & \dots & 0 \\ \vdots & \vdots & \ddots & \vdots \\ g_{N-1} & g_{N-2} & \dots & g_0 \end{bmatrix}$$

The first column of the matrix G is step response coefficient of system [12].

If control horizon is less than prediction horizon ($N_u < N$), in other words the control signal is kept constant after control horizon, ($\Delta u(t+j-1) = 0$ for $j > N_u$), the set of predictions which effect the objective function can be expressed as:

$$\hat{Y} = G_s \Delta U_s + F \quad (13)$$

Where:

$$G_s = \begin{bmatrix} g_0 & 0 & \dots & 0 \\ g_1 & g_0 & \dots & 0 \\ \vdots & \vdots & \ddots & \vdots \\ g_{N-1} & g_{N-2} & \dots & g_{N-N_u} \end{bmatrix}$$

$$\Delta U_s = [\Delta u_s(t)\Delta u_s(t+1)\dots\Delta u_s(t+N_u-1)]^T$$

Now, the objective function of (12) can be rewritten as the following form:

$$J = (G\Delta U + F - W)^T (G\Delta U + F - W) + \dots + \lambda U^T U \quad (14)$$

Where:

$W = [w(t+1), w(t+2), \dots, w(t+N)]^T$ is the reference trajectory.

(Eq.14) can be written as:

$$J = \frac{1}{2} \Delta U^T H \Delta U + b^T \Delta U + F_0 \quad (15)$$

Where:

$$H = 2(G^T G + \lambda I)$$

$$b^T = 2(F - W)^T G \quad (16)$$

$$F_0 = (F - W)^T (F - W)$$

The minimum of J , assuming there are no constraints on the control signals, can be found by making the gradient of J equal to zero, which leads to:

$$\Delta U = -H^{-1}b = (G^T G + \lambda I)^{-1} G^T (W - F) \quad (17)$$

Note that the control signal that is actually sent to the process is the first element of vector ΔU , given by:

$$\Delta u(t) = K(W - F) \quad (18)$$

Where K is the first row of matrix $(G^T G + \lambda I)^{-1} G^T$. This has a clear meaning that can easily be derived from Fig 5. If there are no future predicted errors, that is, if $(W - F) = 0$, then there is no control move, since the objective will be fulfilled with the free evolution of the process. However in the other case, there will be an increment in the control action proportional (with a factor K) to that future error. Notice that the action is taken with respect to future errors, not past errors, as is the case in conventional feedback controllers. Notice that only the first element of ΔU is applied and the procedure is repeated at next sampling time.

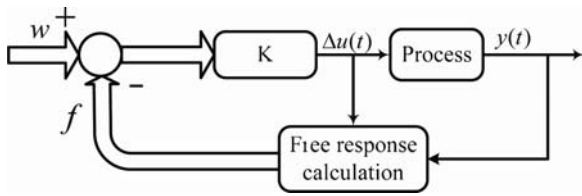

Fig. 5 The GPC Control law

V. APPLICATION TO BATCH REACTOR TEMPERATURE CONTROL

In this section the proposal algorithm is applied to batch polymerization reactor.

Assume that the tuning parameter is: $\beta_1 = 550, \beta_2 = 2.5 \times 10^4$.

Since the batch polymerization reactor is a slow system, the sampling time was chosen to be 20 s. The time is needed for calculation by a 2.5Ghz cpu is 16ms that is suitable for computations.

The temperature profile has been shown in Fig.2. Since GLC method create a linear model for system we can applied set point to linear model and show that the system need to a linear controller to have good performance.

Fig.6 shows output of system when we don't use linear controller. It shows that the GLC method can't track set point and system hasn't good performance.

In Fig.7 we applied MPC controller to system. It shows the ability of MPC controller to output track set point and system has good performance.

The optimum values of parameter are as follows: $N_2 = 8, N_u = 6, \lambda = 0.6$. The performance of proposed controller has been shown in Fig. 8.

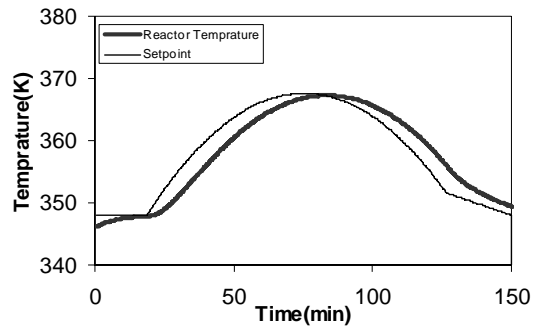

Fig. 6 The GLC Linear model output

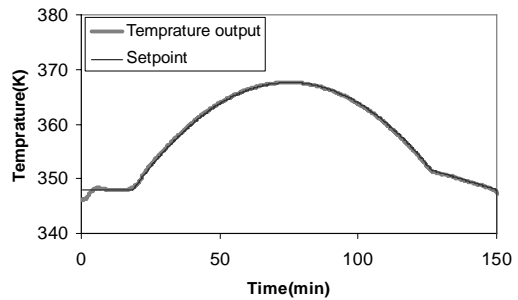

Fig. 7 The MPC controller Response

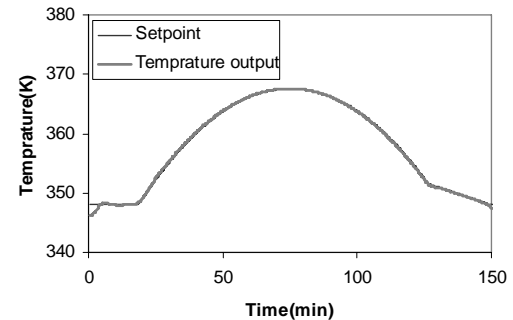

Fig. 8 Performance of the Proposed Controller

Now, we assume that there is a uniform distribute noise in output (Fig.9) then, by $N_2 = 10, N_u = 8, \lambda = 5$ the response of system is shown in Fig.10. it shows that MPC controller has good performance when system effected by noise.

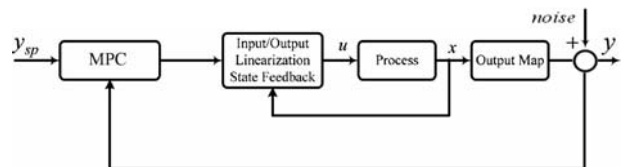

Fig. 9 The overall System with Noise

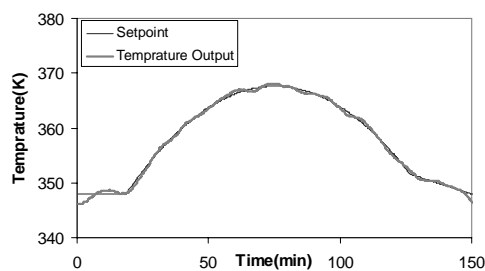

Fig. 10 Robust Performance of the Proposed Controller

VI. CONCLUSION

In this work, a GLC method with MPC controller was developed to control the temperature of batch polymerization reactor. In this method, a feedback linearization method applied to batch reactor to create a linear model and a MPC controller uses this model to control the temperature of reactor. Computer simulations approved that the proposed controller has good performance for tracking reference trajectory. It has been also shown that the proposed controller is robust against output measurement noise.

REFERENCES

- [1] J.F. Macgregor, "Control of Polymerization Reactors," in Proc. Of IFAC, pp.31-35, 1986.W.-K.
- [2] W. H. Ray, 'Polymerization Reactor Control,' in IEEE Cont.Systs.Mag., Vol. 6(4), pp.3-8, 1986.
- [3] M.Tirrell, R. Galvan, and R.L. Laurance, " Polymerization Reactors," in Chemical Reaction and Reactor Engineering, J. J. Carberry and A. Varma, eds., Marcel Dekker,Basel-New York, pp.735-770,1987.
- [4] P. E. Baillagou and D. S. Soong,'Major Factors Contributing to the Nonlinear Kinetics of Free-Radical Polymerization,' in Chem. Eng. Sci., Vol.40, pp.75-87, 1985
- [5] A.Isidori, "Nonlinear Control Systems: An Introduction," 2nd Ed., Springer-Verlag, pp.156-281, 1989. S.
- [6] H.Nijimeijer and A. J. van der Schaft , "Nonlinear Dynamical Control Systems," 1st Ed., Springer-Verlag, pp.176-433,1990.
- [7] C.Karvaris and C.B. Chung, "Nonlinear State Feedback Synthesis by Global Input/output Linearization," in AIChE J., Vol.33, pp.592-603, 1987.
- [8] C.Karvaris and M. Soroush, "Synthesis of Multivariable Nonlinear Controllers by Input/output Linearization," in AIChE J., J.36, pp.249-264, 1990.
- [9] M.soroush and C. Kravaris, "Nonlinear Control of Batch Polymerization Reactors," in Proc.ACC,Boston, pp.2879-2885,1991.
- [10] P. Daoutidis and C. Kravaris, "Dynamic Output Feedback Control of Minimum-Phase Nonlinear Processes," in Chem.Eng.Sci. Vol.47, pp.837-849, 1992.
- [11] Clarke, D.W., Scattolini, R., 1991. Constrained receding horizon predictive control. IEE Proc.-D 138 (July (4)).
- [12] Clarke, D.W., Mohtadi, C., Tuffs, P.S., 1987a. Generalized predictive control—Part I. Basic algorithm. Automatica 23 (2), 137–148.
- [13] M.soroush and C. Kravaris, "Nonlinear Control of a Batch Polymerization Reactor: An Exprimental Study " ,AIChE , vol.38 , No.9, pp.1429-1447, 1992.