

# Mass Transfer of Palm Kernel Oil under Supercritical Conditions

I. Norhuda, and A. K. Mohd Omar

**Abstract**—The purpose of the study was to determine the amount of Palm Kernel Oil (PKO) extracted from a packed bed of palm kernels in a supercritical fluid extractor using supercritical carbon dioxide (SC-CO<sub>2</sub>) as an environmental friendly solvent. Further, the study sought to ascertain the values of the overall mass transfer coefficient (K) of PKO evaluation through a mass transfer model, at constant temperature of 50 °C, 60 °C, and 70 °C and pressures range from 27.6 MPa, 34.5 MPa, 41.4 MPa and 48.3 MPa respectively. Finally, the study also seeks to demonstrate the application of the overall mass transfer coefficient values in relation to temperature and pressure. The overall mass transfer coefficient was found to be dependent pressure at each constant temperature of 50 °C, 60 °C and 70 °C. The overall mass transfer coefficient for PKO in a packed bed of palm kernels was found to be in the range of  $1.21 \times 10^{-4} \text{ m min}^{-1}$  to  $1.72 \times 10^{-4} \text{ m min}^{-1}$  for a constant temperature of 50 °C and in the range of  $2.02 \times 10^{-4} \text{ m min}^{-1}$  to  $2.43 \times 10^{-4} \text{ m min}^{-1}$  for a constant temperature of 60 °C. Similar increasing trend of the overall mass transfer coefficient from  $1.77 \times 10^{-4} \text{ m min}^{-1}$  to  $3.64 \times 10^{-4} \text{ m min}^{-1}$  was also observed at constant temperature of 70 °C within the same pressure range from 27.6 MPa to 48.3 MPa.

**Keywords**—Overall Mass Transfer Coefficient (D), Supercritical Carbon Dioxide (SC-CO<sub>2</sub>), Palm Kernel Oil (PKO).

## I. INTRODUCTION

OIL palm kernels, the by product of the oil palm industry has a great potential for a source of oil and dietary protein [1]. By chemical modification of palm kernel oil (PKO) can alter texture and nutritional requirements for the manufacturing of margarines, cocoa butter, shortenings and other plastic fats [2].

A single palm kernel consists of 49 percent to 52 percent of oil, 26 percent carbohydrates, 8 percent protein and crude fiber and the remaining being moisture [3]. Further understanding on the amount of palm kernel oil (PKO) extracted from a packed bed of palm kernels using SC-CO<sub>2</sub> techniques would contribute to the industrial scale processing of PKO. Thus the role of mass transfer coefficient, temperature and pressure are essential to enhance the extraction rate of PKO using SC-CO<sub>2</sub> techniques. The value of mass transfer coefficient of PKO is vital for design or sizing of SC-CO<sub>2</sub> extractor since the value regulates the rate of mass

transfer during the extraction process. The mass transfer coefficient also regulates the time for oil separation from the palm kernels [4]. In addition, the effects of mass transfer coefficient are also influenced by the temperature and pressure. Studies on the mass transfer phenomena for example, were conducted by Udaya Sankar and Manohar [5] and Brunner [6]. Both studies demonstrated that the extraction process can be described by a coupled of a set of differential equations that take into account first, the time dependent concentration, consequently a time dependent driving force and mean transport coefficient. Secondly, the influences of gas flow.

## II. EXPERIMENTAL APPARATUS

The apparatus used for contacting the palm kernels with supercritical carbon dioxide is shown in Fig. 1. The various components of SC-CO<sub>2</sub> extraction equipment consists of a carbon dioxide cylinder (MOX, Penang) with 99.99 % purity of CO<sub>2</sub>, a chiller (Yih Der BI -730) to liquefy the CO<sub>2</sub> gas, high pressure 100 DX syringe pump with maximum operating pressure of 68.9 MPa (Isco, Inc., Lincoln, NE. U.S.A.), an SFX 220 extractor with size 22.7 cm by 21.2 cm by 24.4 cm (Isco, Inc., Lincoln, NE. U.S.A.), equipped with a 2.5 ml extraction vessels, a heated capillary restrictor 50 μm with maximum operating temperature of 150 °C use to minimize analyte deposition, and a 30 ml vial to collect the analyte.

## III. EXPERIMENTAL PROCEDURE

Samples of palm kernels were obtained from a local palm oil mill. Usually, for commercial purpose, the palm kernels of size 12.5 mm to 13.5 mm outside diameter (o.d) were used. However, due to the limitation of the equipment used, therefore only palm kernels of size of 6 mm o.d., which is around 0.2 g to 0.25 g (wet basis), was chosen in all experiments. The kernels were cleaned and sealed in a plastic bag 708 mm by 762 mm before they were stored in the refrigerator at -20 °C. The air was first removed by squeezing the bags and immediately sealing the open end. All samples were allowed to reach room temperature (27 °C) prior to opening, to prevent condensation and oxidation onto the palm kernels and also to maintain the amount of oil in the palm kernel. Palm kernels of 3 % to 4 % moisture content were used throughout the experimental work.

Palm kernels were placed inside the extractor. Two cartridges with a 3/8 inch stainless steel diameter filter

I. Norhuda is with the Faculty of Chemical Engineering, University Technology MARA, 40450, Shah Alam, Selangor (e-mail: norhuda475@salam.uitm.edu.my).

A. K. Mohd Omar is with School of Industrial Technology, Universiti Sains Malaysia, 11800, Minden, Penang (e-mail: akmomar@usm.my)

element, porosity of 0.5  $\mu\text{m}$ , were placed vertically (top and bottom) in the extractor to prevent small seed fragments from plugging pipes and valves. The extractor was then introduced into the temperature controlled chamber, where the desired temperature for extraction is reached.

Clean empty vessel was installed prior to extraction, and a blank extraction was conducted to purge the SFE system components of oil remaining from the prior extractions. Liquid  $\text{CO}_2$  at predetermined temperature was pumped up to the extraction pressure and directed into the bottom of the extractor.

Dissolved oil and  $\text{CO}_2$  in the supercritical phase were left from the extractor and channeled to the analyte outlet valve, at reduced pressure equivalent to the atmospheric conditions. The  $\text{CO}_2$  leaving the separator was vented out into the atmosphere. Due to the complication potential problems of plugging or non quantitative recovery of PKO, to the solvent density which normally dropped as the solvent and solute traveled down the restrictor, therefore the weight loss method (i.e. sample before and sample after extraction) was used to quantify the amount of PKO extracted. The analytical balance (Mettler accuracy  $\pm 0.0001$ ) was used for this purpose at a specified period of time. For every 10, 20, 30 and 40 minute's extraction, the samples were removed and weighed.

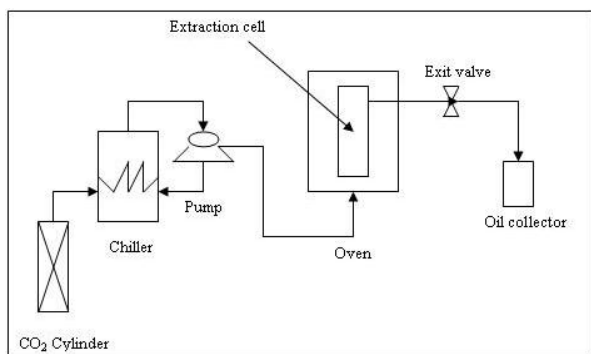

Fig. 1 Supercritical Fluid Extraction Apparatus

#### IV. RESULTS AND DISCUSSION

Results of percentage of palm kernel oil (PKO) extracted from a single palm kernel was plotted against time of extraction at constant temperature of 50 °C, 60 °C and 70 °C with pressures range from 27.6 MPa to 48.3 MPa, and is presented in Fig. 2, Fig. 3 and Fig. 4 respectively. It can be seen that for all conditions studied, the amount of PKO extracted increases almost linearly initially with time. These behavior was similar to the trend observed in other related studies on oil [7], [8] and [9] using supercritical  $\text{CO}_2$ . In addition, pressure is observed to have strong effect on the rate of PKO extraction.

The increased in the amount of PKO extracted at constant temperature of 50 °C, 60 °C and 70 °C is due to the increased in  $\text{CO}_2$  density as pressure increases. Consequently, at higher densities, solubility of PKO in  $\text{SC-CO}_2$  increases due to a higher intermolecular interaction between  $\text{SC-CO}_2$  and oil molecules which enhanced the extraction rate thus resulted in higher amount of PKO extracted. Furthermore, at high

densities the  $\text{SC-CO}_2$  can easily penetrate into the PKO to be extracted, dissolve in it, and carry away the soluble components [10]. This phenomena is also attributed to the solvent ( $\text{SC-CO}_2$ ) selectivity which decreases as the density increased, as a result the solvent tends to select only the oil/solute to be extracted [11].

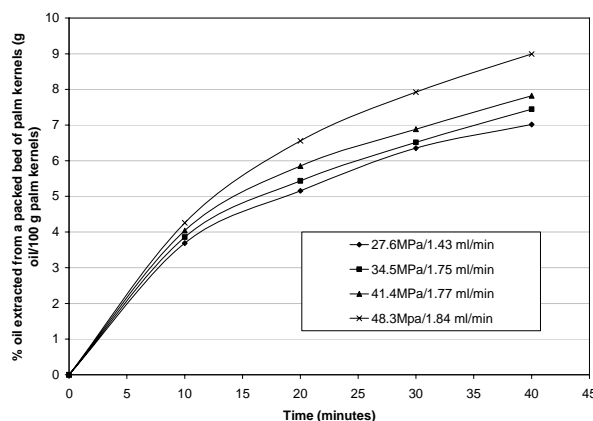

Fig. 2 Percent oil extracted from a single palm kernel versus time at constant temperature of 50 °C and different pressures

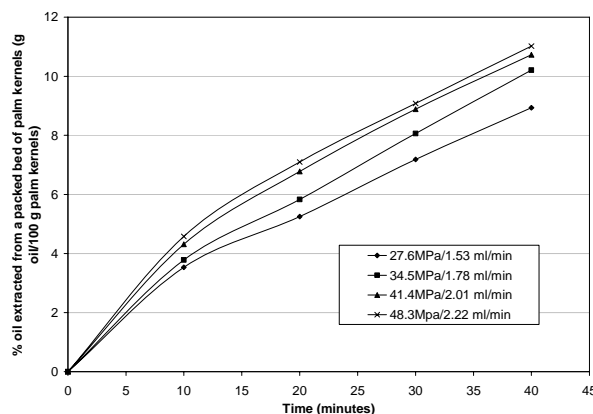

Fig. 3. Percent oil extracted from a single palm kernel versus time at constant temperature of 60 °C and different pressures

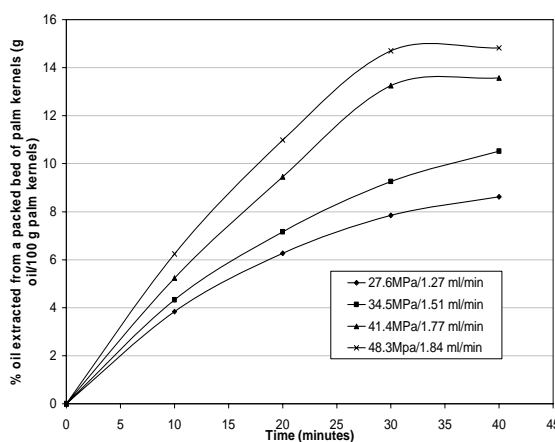

Fig. 4 Percent oil extracted from a single palm kernel versus time at constant temperature of 70 °C and different pressures

### V. MASS TRANSFER MODEL

The overall mass transfer of PKO in a packed bed of palm kernels in an extractor was determined by using Equation of Lee, et. al. [12] as given below:

$$\frac{dC}{dt} = KA(C^* - C) \quad (1)$$

where

- C = concentration of PKO in the SC-CO<sub>2</sub> phase (kg/kg).
- C\* = equilibrium value of C (kg/kg).
- A = specific surface area (cross sectional area /volume of bed) (m<sup>2</sup>).
- K = overall mass transfer coefficient of PKO through the SC-CO<sub>2</sub> phase (m min<sup>-1</sup>).
- t = time of extraction (min).

The determination of the overall mass transfer coefficient of PKO is based on the following assumptions:

- (1) The overall palm kernels are considered spherical in shape with uniform size.
- (2) The equilibrium phase between the PKO in fluid carbon dioxide (CO<sub>2</sub>) and the solid matrix in the extractor had not yet reached because CO<sub>2</sub> was fed continuously so that the palm kernels, always fixed at its place until the extraction process completed. This condition was essential to ensure PKO continuously absorbed into the fluid phase until the driving force (C\*-C) approached zero.
- (3) The solubility of PKO in the fluid phase is not influence by the flow rates of the carbon dioxide.

The driving force was the difference between the initial PKO content in the palm kernels to the PKO extracted (C\*-C). It should be noted that the equilibrium concentration C\* was actually the initial PKO content in the palm kernels and was determined by using soxhlet extraction method [13] Initial PKO content is considered in the assumption because the equilibrium between PKO in the solid matrix and in the SC-CO<sub>2</sub> phase could not be reached during the extraction process.

Based on the experimental data obtained as illustrated in Fig. 2, Fig. 3 and Fig. 4, by plotting -ln(1- C/ C\*) versus time (t), a linear graph could be observed as shown in Fig. 5, Fig. 6 and Fig. 7.

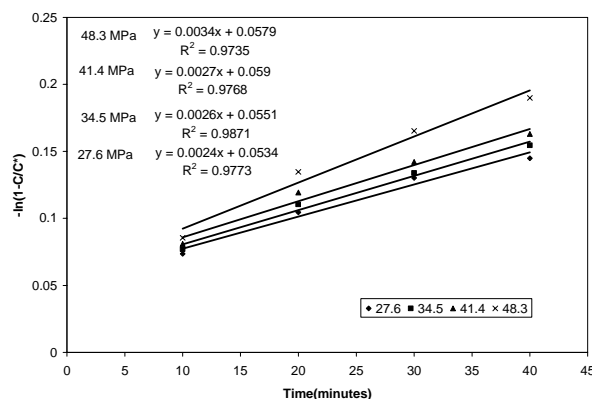

Fig. 5 Graph – ln (1-C/C\*) as a function of time at constant temperature of 50 °C and different pressures

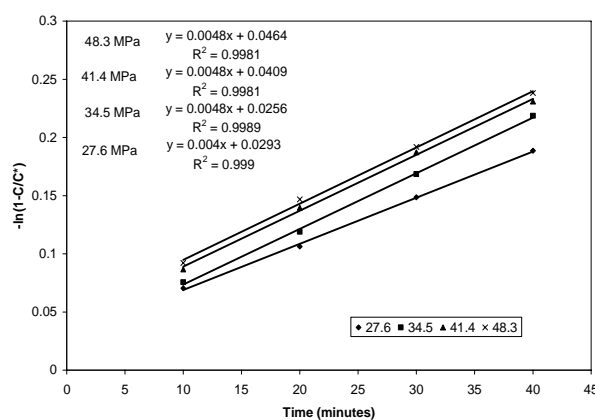

Fig. 6 Graph – ln (1-C/C\*) as a function of time at constant temperature of 60 °C and different pressures

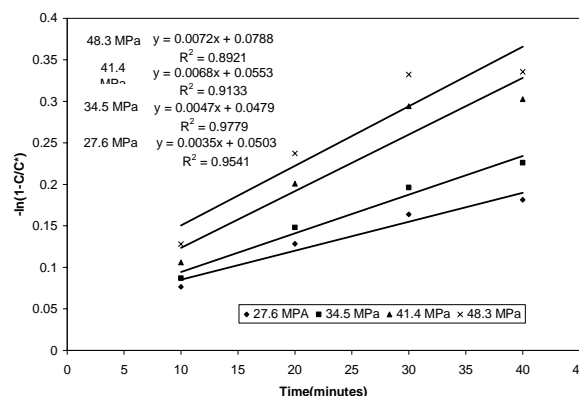

Fig. 7 Graph – ln (1-C/C\*) as a function of time at constant temperature of 70 °C and different pressures

Based on the slopes obtained from Fig. 5, Fig. 6 and Fig. 7, the values of overall mass transfer coefficient of PKO could be determined, and is tabulated in Table I. As can be seen in Table I, all results show that, at a constant temperature of 50 °C, 60 °C and 70 °C, the overall mass transfer coefficient of PKO increases with increasing pressure from 27.6 MPa to 48.3 MPa. The increased of the overall mass transfer

coefficient with pressure were due to the high penetration of SC-CO<sub>2</sub> fluid in the palm kernels (solid matrix), since much of the palm kernel oil (PKO) or the solute were accumulated on the surface of the palm kernels. With the effect of solubility, the SC-CO<sub>2</sub> could easily mix with the PKO and finally diffused out of the solid matrix to the bulk fluid with higher mass transfer rate as pressures increases.

## VI. CONCLUSION

Within the system studied, the overall mass transfer coefficient of PKO obtained at supercritical conditions were found to increase with pressure. The overall mass transfer coefficient was found to be in the range of  $(1.21 \times 10^{-4}$  to  $1.72 \times 10^{-4})$  m min<sup>-1</sup> at constant temperature of 50 °C, in the range of  $(2.02 \times 10^{-4}$  to  $2.43 \times 10^{-4})$  m min<sup>-1</sup> at constant temperature of 60 °C and in the range of  $(1.77 \times 10^{-4}$  to  $3.64 \times 10^{-4})$  m min<sup>-1</sup> at constant temperature of 70 °C within pressure range from 27.6 MPa to 48.3 MPa.

TABLE I  
OVERALL MASS TRANSFER COEFFICIENT OF PKO AT CONSTANT TEMPERATURE AND VARIATION IN PRESSURES

Operating Parameters		Overall Mass Transfer Coefficient of PKO in a Packed Bed of Palm Kernels in an Extractor 10 <sup>-4</sup> (m min <sup>-1</sup> )
Temperature (°C)	Pressure (MPa)	
50	27.6	1.214
	34.5	1.316
	48.3	1.720
60	27.6	2.024
	34.5	2.429
	48.3	2.429
70	27.6	1.771
	34.5	2.378
	48.3	3.643

## REFERENCES

- [1] Sreedhara, N., C.Arumughan and C.S.Narayanan, Dehulling of Palm Kernel of Oil Palm to Obtain Superior - Grade Palm Kernel Flour and Oil, Chem Soc. (1992), 69, 10, 1015-1018.
- [2] Zaida Zainal and Mohd Suria Affandi Yusoff, Enzymatic Esterification of Palm Stearin and Palm Kernel Olein, J.Am.Oil.Soc. (1999), 76, 9, 1003-1008.
- [3] Tang, T.S., and Teoh, P.K., Palm Kernel Oil Extraction-The Malaysian Experience. JAOCS (1985), 62 (2), 254-258.
- [4] Treybal R.E., Mass Transfer Operations, third ed. (Mc.Graw Hill, 1981).
- [5] Udaya Sankar, K., and Manohar, B., Supercritical Fluid Carbon Dioxide Technology for Extraction of Spices and other High Value Bio-active Compounds, Supercritical Fluids Processing and Biomaterials (1994), 155-166.
- [6] Brunner, G., Mass Transfer from Solid Material in Gas Extraction. Phys. Chem. (1994), 88, 887.
- [7] Lee, H., Chung, B.H., and Park, Y.H., Concentration of Tocopherols from Soybean Sludge by Supercritical Carbon Dioxide. JAOCS (1991), 8, (8), 571-573.
- [8] List, G.R., King J.W., Johnson, J.H., Warner, K., Mounts, T.L., Supercritical CO<sub>2</sub> Degumming and Physical Refining of Soybean Oil," J.Am.Oil.Chem.Soc. (1993), 70, 473.

- [9] Goncalves, M., Vasconcelos, M.P., GomesdeAzevedo, E.J.S., Chaves H.J., das Neves, Nunes M., da Ponte, Application of Supercritical Fluid Extraction to the Acidification of Olive Oils, J.Am.Oil Chem. Soc.(1991), 68, 474.
- [10] Friedrich, J.P., Supercritical CO<sub>2</sub> Extraction of Lipids from Lipids-containing Materials. U.S. Patent 4 (1984), 466,923.
- [11] Majewski, W., P.Mengal, M.Perrut, J.P.Ecalard, Supercritical Fluid Fractionation of Butter Oil, Proceedings: Supercritical Fluid Processing of Biomaterials: Basics of Process Design and Applications Symposium, Toronto, 123 (1991).
- [12] Lee B-C, Kim, J.D., Hwang, K-H and Lee, Y.Y., Extraction of oil from Evening Primrose seed with Supercritical Carbon Dioxide, Supercritical Fluid Processing of Food and Biomaterials, Glasgow, N.Z. (1994), 168-180.
- [13] PORIM Test Methods, (1995). Palm Oil Research Institute of Malaysia



**Norhuda Ismail** is a senior lecturer at the Faculty of Chemical Engineering, Universiti Teknologi MARA, Malaysia. She obtained her B. (Eng.) in Chemical at Universiti Teknologi Malaysia in 1990, and her M.Sc. in Environment at Universiti Putra, Malaysia and her PhD in Chemical Engineering at the Universiti Sains, Malaysia. Her research interests are in mass transfer, environmental engineering, and separation processes particularly in the field of supercritical fluids. I.Norhuda was employed as a Quality Assurance Executive in the process industries for several years. She has research collaborated with several oil and gas industries such as AMOCO, Petroleum Nasional Malaysia (PETRONAS), BASF-PETRONAS, MTBE and also other industries such as Malaysia Institute of Nuclear Technology (MINT) and Malaysia Airlines System (MAS), in areas pertaining to Chemical Engineering. She is a member of Board of Engineers Malaysia since 1994.



**Mohd Omar Abdul Kadir** is currently a professor in the School of Industrial Technology, Universiti Sains Malaysia (USM). He obtained his Bachelor and Master Degree in Chemical Engineering at Mississippi State University, USA, and his PhD at MTU, USA. He joined USM in 1989 and is a professional Chemical Engineer active both in engineering research of Supercritical Fluid Technology as

well as in the area of industrial wastewater treatment plant design and built, environmental audit and hazardous waste handling. He has a patent in supercritical fluid technology in palm kernel oil extraction and is also an active member of the Japanese Supercritical Research Group of Tohoku University. He is widely recognized in the area of industrial wastewater treatment. He is a consultant to many local and international companies in the same area. He has over 150 papers in refereed journals, proceedings, presented at international and local conferences. He is a committee member of the National Air Quality Committee, member of American Institute of Chemical Engineers (AIChE), U.S.A. since 1993, member of Specialist Group on Small Wastewater Treatment Plants (IAWQ), United Kingdom and others.