

Fuzzy Logic Speed Control of Three Phase Induction Motor Drive

P.Tripura and Y.Srinivasa Kishore Babu

Abstract—This paper presents an intelligent speed control system based on fuzzy logic for a voltage source PWM inverter-fed indirect vector controlled induction motor drive. Traditional indirect vector control system of induction motor introduces conventional PI regulator in outer speed loop; it is proved that the low precision of the speed regulator debases the performance of the whole system. To overcome this problem, replacement of PI controller by an intelligent controller based on fuzzy set theory is proposed. The performance of the intelligent controller has been investigated through digital simulation using MATLAB-SIMULINK package for different operating conditions such as sudden change in reference speed and load torque. The simulation results demonstrate that the performance of the proposed controller is better than that of the conventional PI controller.

Keywords—Fuzzy Logic, Intelligent controllers, Conventional PI controller, Induction motor drives, indirect vector control, Speed control

I. INTRODUCTION

FOR electrical drives good dynamic performance is mandatory so as to respond to the changes in command speed and torques. These requirements of AC drives can be fulfilled by the vector control system. With the advent of the vector control method, an induction motor has been controlled like a separately excited DC motor for high performance applications. This method enables the control of field and torque of induction motor independently (decoupling) by manipulating corresponding field oriented quantities [1], [2].

The traditional indirect vector control system uses conventional PI controller in the outer speed loop because of the simplicity and stability. However, unexpected change in load conditions or environmental factors would produce overshoot, oscillation of motor speed, oscillation of the torque, long settling time and thus causes deterioration of drive performance. To overcome this, an intelligent controller based on Fuzzy Logic can be used in the place of PI regulator [4]. The fuzzy logic has certain advantages compared to classical controllers such as simplicity of control, low cost, and the possibility to design without knowing the exact mathematical model of plant [3].

In this paper application of fuzzy logic to the intelligent speed control of indirect vector controlled induction motor drive is investigated. The analysis, design and simulation of controller have been carried out based on the fuzzy set theory.

When a new control strategy of a converter or a drive system is formulated, it is often convenient to study the system performance by simulation before building the breadboard or prototype. The simulation not only validates the systems operation, but also permits optimization of the systems performance by iteration of its parameters. Besides the control

and circuit parameters, the plant parameter variation effect can be studied. Valuable time is thus saved in the development and design of the product, and the failure of components of poorly designed systems can be avoided. The simulation program also helps to generate real time controller software codes for downloading to a microprocessor or digital signal processor.

Many circuit simulators like PSPICE, EMTP, MATLAB/SIMULINK incorporated these features. The advantages of SIMULINK over the other circuit simulator are the ease in modeling the transients of electrical machines and drives and to include controls in the simulation. To solve the objective of this paper MATLAB/ SIMULINK software is used. The superior control performance of the proposed controller is demonstrated at SIMULINK platform using the fuzzy logic tool box [5] for different operating conditions.

The complete paper is organized as follows: Section II describes the indirect vector control system. The design and description of intelligent controller is provided in section III. The simulation results, comparison and discussion are presented in Section IV. Section V concludes the work.

II. INDIRECT VECTOR CONTROL SYSTEM

For the high performance drives, the indirect method of vector control is preferred choice [1], [2]. The indirect vector control method is essentially same as the direct vector control, except that the rotor angle θ_e is generated in an indirect manner (estimation) using the measured speed ω_r and the slip speed ω_{sl} . To implement the indirect vector control strategy, it is necessary to take the following dynamic equations into consideration.

$$\theta_e = \int \omega_e dt = \int (\omega_r + \omega_{sl}) dt = \theta_r + \theta_{sl} \quad (1)$$

For decoupling control, the stator flux component of current i_{ds} should be aligned on the d^e axis, and the torque component of current i_{qs} should be on q^e axis, that leads to $\psi_{qr} = 0$ and $\psi_{dr} = \psi_r$ then:

$$\frac{L_r}{R_r} \frac{d\psi_r}{dt} + \psi_r = L_m i_{ds} \quad (2)$$

As well, the slip frequency can be calculated as:

$$\omega_{sl} = \frac{L_m R_r}{\psi_r L_r} i_{qs} = \frac{R_r i_{qs}}{L_r i_{ds}} \quad (3)$$

It is found that the ideal decoupling can be achieved if the above slip angular speed command is used for making field-orientation. The constant rotor flux ψ_r and $\frac{d\psi_r}{dt} = 0$ can be substituted in equation (2), so that the rotor flux sets as

$$\psi_r = L_m i_{ds} \quad (4)$$

P.Tripura is with the Vignan's Nirula Institute of Science & Technology for Women, Guntur, A.P., INDIA (e-mail: tripura.pidikiti@gmail.com).

Y.Srinivasa Kishore Babu is with Vignan University, Vadlamudi, Guntur, A.P., India (e-mail: yskbabu@gmail.com).

The Simulink model for such an indirect vector control system is shown in the Fig. 3. This control technique operates the induction motor as separately excited DC motor so as to achieve high dynamic performance [1], [2].

III. DESIGN AND DESCRIPTION OF INTELLIGENT CONTROLLER

Since the implementation of off-line tuning of PI controller is difficult in dealing with continuous parametric variation in the induction motor as well as the non-linearity present in the entire system, it becomes of interest to go for intelligent controller. It is known that the stator and rotor resistances of induction motor may change with the temperature up to 50% and motor inductance varies with the magnetic operating point. Furthermore, the load torque may change due to mechanical disturbances.

The problem can be solved by several adaptive control techniques such as model reference adaptive control, sliding-mode control, variable structure control, and self-tuning PI controllers, etc. The theory and survey on model reference adaptive system has been reported by H. Sugimoto et.al [6]. Secondary resistance identification of an IM applied with MRAS and its characteristics has been presented in their study. The improved version of sliding mode control for an IM has been proposed by C. Y. Won et.al [7]. The design of integral variable structure control system for servo systems has been proposed by T. L. Chern et.al [8]. The self tuning controllers are described by J. C. Hung [9]. However, in all these works, exact mathematical model of the system is mandatory to design the adaptive control algorithm. Thus they increase the complexity of design and implementation.

When fuzzy logic based intelligent controller is used instead of the PI controller, excellent control performance can be achieved even in the presence of parameter variation and drive non-linearity [1], [3].

In addition, the fuzzy logic posses the following advantages: (1) The linguistic, not numerical, variables make the process similar to the human think process. (2) It relates output to input, without understanding all the variables, permitting the design of system more accurate and stable than the conventional control system. (3) Simplicity allows the solution of previously unsolved problems. (4) Rapid prototyping is possible because, a system designer doesn't have to know everything about the system before starting work. (5) It has increased robustness. (6) A few rules encompass great complexity.

The vector control of IM with fuzzy PI controller has been proposed by I. Miki et.al [10] and W. P. Hew et.al [11]. As they reported, the FLC automatically updates the proportional and integral gains on-line and thus help in achieving fast dynamic response. However, this technique does not fully utilize the capabilities of the fuzzy logic. Moreover, the inherent disadvantages associated with the PI controller cannot be avoided. The fuzzy PI controllers are less useful in industrial applications.

The performances of the fuzzy logic based indirect vector control for induction motor drive has been proposed by M. N. Uddin et.al [12], E. Cerruto et.al [13], B. Heber et.al [14], and G. C. D. Sousa et.al [15]. The novel speed control for current regulated VSI-fed IM has been discussed by them. The fuzzy

logic based controller for IM drives has been proposed by Minh Ta-Cao et.al [16]. The performance of the proposed system is compared with the conventional vector control on the basis of Integral of time by Absolute Time Error (IATE).

The Simulink implementation of current regulated VSI-fed IM is proposed by Norman Mariun et.al [17] and Vinod Kumar et.al [18]. They proposed a fuzzy logic controller in place of PI controller in the vector control system. However, the power system block set used by them makes use of S-functions and it is not as easy to work with as the rest of the Simulink blocks.

The work presented in [12]-[18] uses a fuzzy logic controller to set the torque component of reference current based on speed error and change of speed error. The inverter is then switched to follow the reference current within hysteresis band. However, the constant hysteresis band of the current regulated PWM inverter of the fuzzy logic based indirect vector control system possesses problem in achieving superior dynamic performance, even the drive control system includes the efficient fuzzy logic controller. This paper discusses the fuzzy logic speed control for VSI fed indirect vector controlled induction motor drives.

Fig. 1 shows the block diagram of fuzzy logic based speed control system. Such a fuzzy logic controller consists of four basic blocks viz., Fuzzification, Fuzzy Inference Engine, Knowledge base and defuzzification.

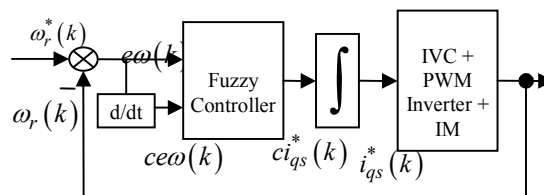

Fig. 1 Block diagram of Fuzzy logic speed control system for indirect vector controlled induction motor drive

A. Input/ Output variables

The design of the fuzzy logic controller starts with assigning the input and output variables. The most significant variables entering the fuzzy logic speed controller has been selected as the speed error and its time variation. Two input variables $e\omega(k)$ and $ce\omega(k)$, are calculated at every sampling instant as:

$$e\omega(k) = \omega_r^*(k) - \omega_r(k) \quad (5)$$

$$ce\omega(k) = e\omega(k) - e\omega(k-1) \quad (6)$$

where $\omega_r^*(k)$ is the reference speed, $\omega_r(k)$ is the actual rotor speed and $e\omega(k-1)$ is the value of error at previous sampling time.

The output variable of the fuzzy logic speed controller is the variation of command current, $ci_{qs}^*(k)$ which is integrated to get the reference command current, $i_{qs}^*(k)$ as shown in the following equation.

$$i_{qs}^*(k) = i_{qs}^*(k-1) + ci_{qs}^*(k) \quad (7)$$

B. Fuzzification

The success of this work, and the like, depends on how good this stage is conducted. In this stage, the crisp variables $e\omega(k)$ and $ce\omega(k)$ are converted in to fuzzy variables $e\omega$ and $ce\omega$ respectively. The membership functions associated to the control variables have been chosen with triangular shapes as shown in Fig. 2.

The universe of discourse of all the input and output variables are established as $(-0.8, 0.8)$. The suitable scaling factors are chosen to brought the input and output variables to this universe of discourse. Each universe of discourse is divided into seven overlapping fuzzy sets: NL (Negative Large), NM (Negative Medium), NS (Negative Small), ZE (Zero), PS (Positive Small), PM (positive Medium), and PL (Positive Large). Each fuzzy variable is a member of the subsets with a degree of membership μ varying between 0 (non-member) and 1 (full-member). All the membership functions have asymmetrical shape with more crowding near the origin (steady state). This permits higher precision at steady state [3].

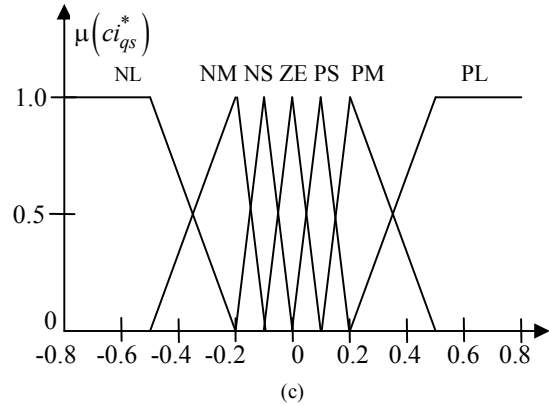
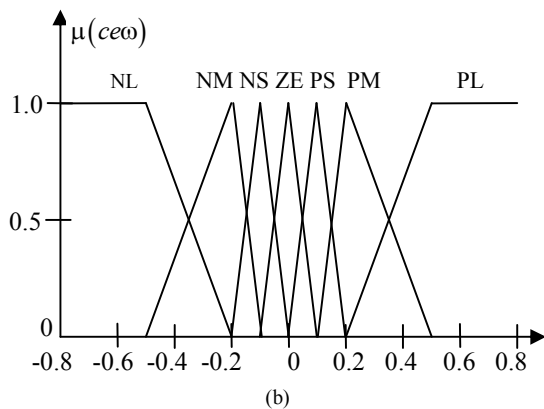
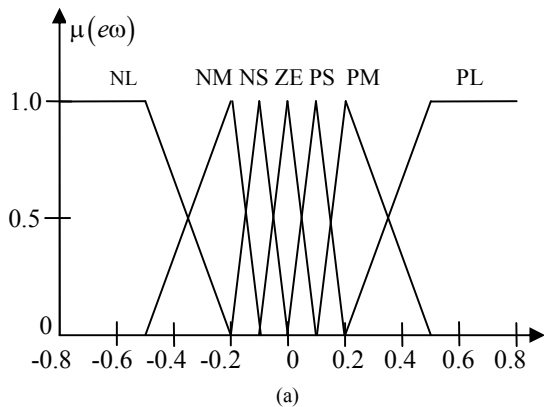

Fig. 2 Membership functions for (a) speed error (b) change of speed error (c) Change of command current

C. Knowledge base and Inference Stage

Knowledge base involves defining the rules represented as IF-THEN statements governing the relationship between input and output variables in terms of membership functions. In this stage, the variables $e\omega$ and $ce\omega$ are processed by an inference engine that executes 49 rules (7x7) as shown in Table I. These rules are established using the knowledge of the system behavior and the experience of the control engineers. Each rule is expressed in the form as in the following example: IF ($e\omega$ is Negative Large) AND ($ce\omega$ is Positive Large) THEN (ci_{qs}^* is Zero). Different inference engines can be used to produce the fuzzy set values for the output fuzzy variable ci_{qs}^* . In this paper, the Max-product inference method [3] is used.

TABLE I
FUZZY CONTROL RULES

e	NL	NM	NS	ZE	PS	PM	PL
ce	NL	NL	NL	NL	NM	NS	ZE
NL	NL	NL	NL	NM	NS	ZE	PS
NM	NL	NL	NM	NS	ZE	PS	PM
NS	NL	NM	NS	ZE	PS	PM	PL
ZE	NM	NS	ZE	PS	PM	PL	PL
PS	NS	ZE	PS	PM	PL	PL	PL
PM	NS	ZE	PS	PM	PL	PL	PL
PL	ZE	PS	PM	PL	PL	PL	PL

D. Defuzzification

In this stage a crisp value of the output variable $ci_{qs}^*(k)$ is obtained by using height defuzzification method, in which the centroid of each output membership function for each rule is first evaluated. The final output is then calculated as the average of the individual centroid, weighted by their heights (degree of membership) as follows:

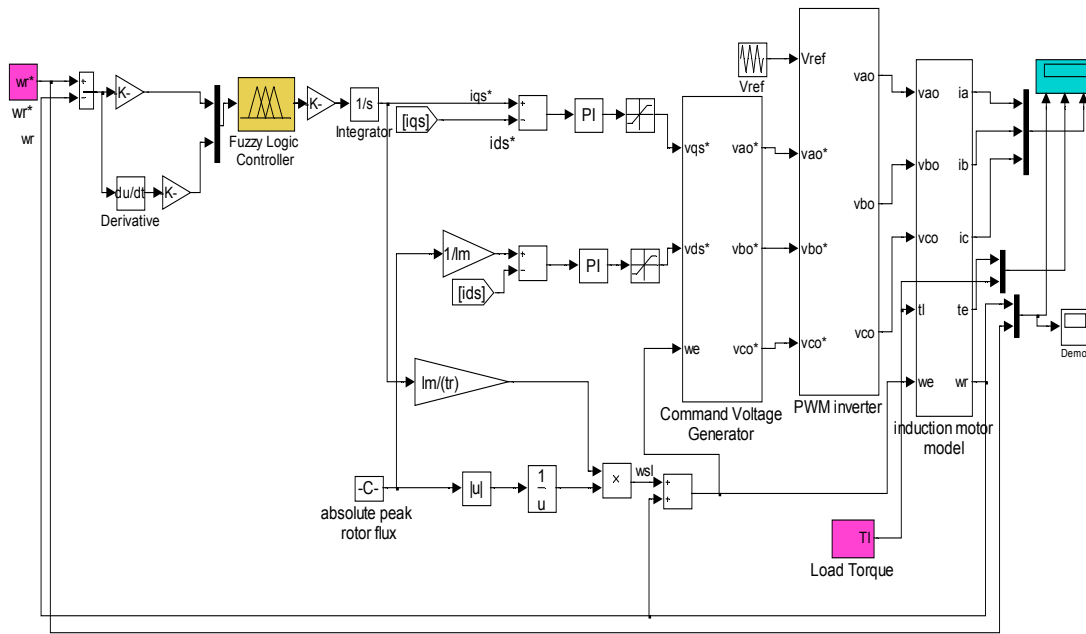

Fig. 3 Indirect vector controlled induction motor block diagram with the Fuzzy Logic Controller

$$ci_{qs}^*(k) = \frac{\sum_{i=1}^n \mu [(ci_{qs}^*)_i] (ci_{qs}^*)_i}{\sum_{i=1}^n \mu [(ci_{qs}^*)_i]} \quad (8)$$

The reference value of command current $i_{qs}^*(k)$ that is applied to vector control system is computed by the equation (7).

The overall model for fuzzy logic based speed control system for indirect vector controlled induction motor drive is shown in Fig. 3. The parameters of the motor are given in appendix.

IV. SIMULATION RESULTS AND DISCUSSION

A series of simulation tests were carried out on indirect vector controlled induction motor drive using both the PI controller and fuzzy logic based intelligent controller for various operating conditions. The time response and steady state errors were analyzed and compared.

Figures 4 and 5 shows speed response with both the PI and FL based controller. The FL controller performed better performance with respect to rise time and steady state error.

Figure 6 shows the load disturbance rejection capabilities of each controller when using a step load from 0 to 20 N-m at 0.8 seconds. The FL controller at that moment returns quickly to command speed, where as the PI controller maintains a steady state error.

Figure 7 shows the speed tracking performance test, when sudden change in speed reference is applied in the form of

look-up table. The intelligent controller exhibited better speed tracking compared to PI controller.

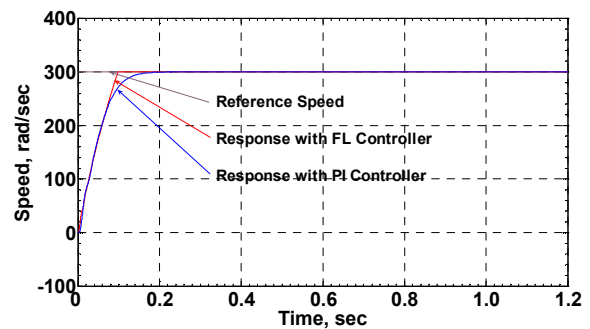

Fig. 4 Speed response comparison at no-load

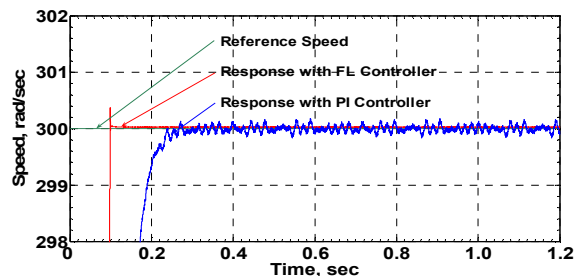

Fig. 5 Enlarged speed response comparison at no-load

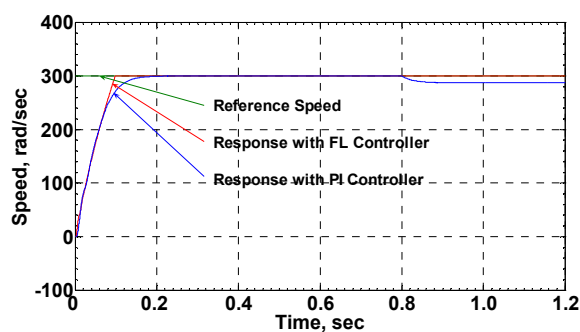

Fig. 6 Speed response comparison during sudden load change

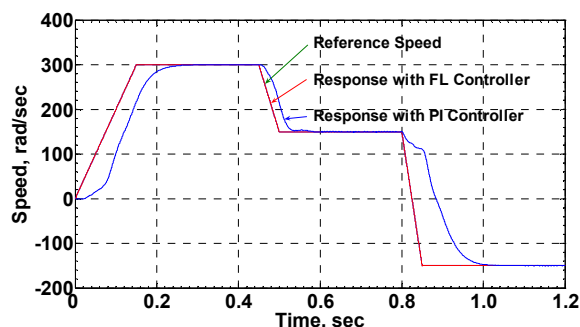

Fig. 7 Speed tracking response comparison

V. CONCLUSION

The performance of fuzzy logic based intelligent controller for the speed control of indirect vector controlled, PWM voltage source inverter fed induction motor drive has been verified and compared with that of conventional PI controller performance. The simulation results obtained have confirmed the very good dynamic performance and robustness of the fuzzy logic controller during the transient period and during the sudden loads. It is concluded that the proposed intelligent controller has shown superior performance than that of the parameter fixed PI controller and earlier proposed system [4].

APPENDIX

3-Phase Induction Motor Parameters

Rotor type: Squirrel cage,

Reference frame: Synchronous

10 hp, 314 rad/sec, 4 Poles, $R_s = 0.19 \Omega$, $R_r = 0.39 \Omega$, $L_{ls} = 0.21e-3$ H, $L_{lr} = 0.6e-3$ H, $L_m = 4e-3$ H, $J = 0.0226$ Kg-m².

REFERENCES

- [1] Bimal K. Bose, *Modern Power Electronics and AC Drives*, Third impression, INDIA: Pearson Education, Inc., 2007.
- [2] Blaschke F, "The Principle of Field-Oriented Control as applied to the New Transvector Closed-Loop Control System for Rotating-Field Machines," *Siemens Review*, Vol. 34, pp. 217-220, May 1972.
- [3] C. C. Lee, "Fuzzy Logic in Control Systems: Fuzzy Logic Control – Part 1," *IEEE Transactions on Systems, Man and Cybernetics*, Vol. 20, No. 2, pp. 404-418, March/April, 1990.
- [4] M. N. Uddin, T. S. Radwan and M. A. Rahman "Performances of Fuzzy-Logic-Based Indirect Vector Control for Induction Motor Drive,"

IEEE Transactions on Industry Applications, Vol. 38, No. 5, pp. 1219-1225, September/October, 2002.

- [5] <http://www.mathworks.com/> (The official site for MATLAB&SIMULINK as well as Fuzzy Logic Toolbox).
- [6] H. Sugimoto and S. Tamai, "Secondary resistance identification of an Induction Motor Applied Model reference Adaptive Systems and its Characteristics", *IEEE Trans. on Ind. Appl.*, Vol IA-23, No.1, pp.296-303, Mar/Apr, 1987.
- [7] C. Y. Won and B. K. Bose, "An induction Motor servo Systems with Improved Sliding Mode Control", in *Proc. IEEE IECON'92*, pp. 60-66.
- [8] T. L. Chern and Y. C. Wu, "Design of Integral Variable Structure Controller and Applications to Electro Hydraulic Velocity Servo Systems", *Proc. In Elec. Eng.*, Vol. 138, no. 5, pp. 439-444, Sept. 1991.
- [9] J. C. Hung, "Practical Industrial Control techniques", in *Proc. IEEE IECON'94*, pp. 7-14.
- [10] Miki, N. Nagai, S. Nishigama, and T. Yamada, "Vector control of induction motor with fuzzy PI controller", *IEEE IAS Annu. Meet. Conf. Rec.*, pp. 342-346, 1991.
- [11] W. P. Hew, M. R. Tamjis, and S. M. Saddique, "Application of Fuzzy Logic in Speed Control of Induction Motor Vector Control", *Proc. Of the international conference on Robotics, vision and Parallel Processing for Industrial Automation*, pp. 767-772, Ipoh, Malasiya, Nov. 28-30, 1996
- [12] M. N. Uddin, T. S. Radwan and M. A. Rahman "Performances of Fuzzy-Logic-Based Indirect Vector Control for Induction Motor Drive," *IEEE Transactions on Industry Applications*, Vol. 38, No. 5, pp. 1219-1225, September/October, 2002.
- [13] E. Cerruto, A. Consoli, A. Raciti and A. Testa, "Fuzzy Adaptive Vector Control of Induction Motor Drives", *IEEE Trans. on Power Electronics*, Vol.12, No. 6, pp. 1028-1039, Nov. 1997.
- [14] B. Hebetler, L. Xu, and Y. Tang, "Fuzzy Logic Enhanced Speed Control of Indirect Field Oriented Induction Machine Drive", *IEEE Trans. On Power Electronics*, Vol.12, No.5. pp. 772-778, Sept.1997.
- [15] G. C.D. Sousa, B.K. Bose and J.G. Cleland, "Fuzzy Logic based On-Line Efficiency Optimization Control of an Indirect Vector Controlled Induction Motor Drive", *IEEE Trans. On Industrial Electronics*, Vol. 42, No. 2, pp.192-198, April 1995.
- [16] Minh Ta-Cao, J. L. Silva Neto and H. Le-Huy, "Fuzzy Logic based Controller for Induction Motor Drives", *Canadian Conference on Electrical and Computer Engineering*, Volume 2, Issue, 26-29 May 1996 Page(s):631 - 634 vol.2.
- [17] Norman Mariun, Samsul bahari Mohd Noor, J. Jasni and O. S. Bennanes, "A Fuzzy Logic based Controller for an Indirect Vector Controlled Three-Phase Induction Motor", *IEEE Region 10 Conference, TENCON 2004*, Volume D, Issue. 21-24 Nov. 2004 Page(s): 1-4 Vol. 4
- [18] Vinod Kumar, R. R. Joshi, "Hybrid Controller based Intelligent Speed Control of Induction Motor", *Journal of Theoretical and Applied Information Technology*, December 2006, Vol. 3 No. 1, pp. 71- 75.