

Multi-Line Flexible Alternating Current Transmission System (FACTS) Controller for Transient Stability Analysis of a Multi-Machine Power System Network

A.V.Naresh Babu and S.Sivanagaraju

Abstract—A considerable progress has been achieved in transient stability analysis (TSA) with various FACTS controllers. But, all these controllers are associated with single transmission line. This paper is intended to discuss a new approach i.e. a multi-line FACTS controller which is interline power flow controller (IPFC) for TSA of a multi-machine power system network. A mathematical model of IPFC, termed as power injection model (PIM) presented and this model is incorporated in Newton-Raphson (NR) power flow algorithm. Then, the reduced admittance matrix of a multi-machine power system network for a three phase fault without and with IPFC is obtained which is required to draw the machine swing curves. A general approach based on L-index has also been discussed to find the best location of IPFC to reduce the proximity to instability of a power system. Numerical results are carried out on two test systems namely, 6-bus and 11-bus systems. A program in MATLAB has been written to plot the variation of generator rotor angle and speed difference curves without and with IPFC for TSA and also a simple approach has been presented to evaluate critical clearing time for test systems. The results obtained without and with IPFC are compared and discussed.

Keywords—Flexible alternating current transmission system (FACTS), first swing stability, interline power flow controller (IPFC), power injection model (PIM).

I. INTRODUCTION

THE recently developed converter based FACTS controllers are static synchronous compensator (STATCOM), static synchronous series compensator (SSSC), unified power flow controller (UPFC) and interline power flow controller (IPFC). All these FACTS controllers employ the voltage sourced converter as basic building block and plays vital role in power system stability analysis, especially in transient stability analysis because of fast and reliable control over the basic transmission system parameters, such as voltage magnitude, phase angle and line impedance [1]. Transient stability analysis is an important analysis in the operation and planning of power system network [2]. The use of various FACTS controllers for transient stability analysis has been addressed [3]-[7]. The co-ordinated excitation and

UPFC control to improve power system transient stability and voltage stability has been reported [8]. [9] presents a new control strategy, which has superior performance compared to the conventional control strategy for transient stability improvement in the presence of advanced static VAR compensators (ASVC). [10] Proposes a new control strategy of shunt FACTS devices to improve the first swing stability limit of simple power system which provide significantly higher stability limit than that of bang-bang control (BBC). [11] Depicts the advantage of the use of thyristor controlled series compensator (TCSC) with suitable controller over fixed capacitor operation for transient stability improvement of a multi-machine power system using trajectory sensitivity analysis. [12] Investigates the impact of different static synchronous series compensator (SSSC) control modes on small-signal and transient stability of power system and it is concluded that the use of SSSC in the constant impedance emulation mode is the most beneficial strategy to improve both the small-signal and transient stability.

The optimal location of shunt FACTS controllers for transient stability improvement employing genetic algorithm has been presented [13]. The transient stability constrained optimal power flow (TSOPF) is a big challenge in the field of power system operation because of its computational complexity. The different methods to find the solution for TSOPF problem has been discussed [14]-[18]. Careful study of the former literature reveals that the FACTS controllers used for transient stability analysis is associated with single transmission line. But, in this paper a multi-line FACTS controller which is interline power flow controller (IPFC) has been used for transient stability analysis of multi-machine power system network. Determination of suitable location for the FACTS controllers is a typical problem. In this paper, the best location for the test system is obtained based on L-index. Generator rotor angle, rotor speed and fault clearing time have been used to assess transient stability margin of power system network. The system loads are converted to constant admittances. The numerical results on the two test systems have demonstrated the feasibility and effectiveness of the IPFC model for transient stability analysis.

The rest of the paper is organized as follows: Section II derives power injection model of IPFC. Section III describes the suitable location of IPFC. Section IV gives overall solution procedure. Section V demonstrates the effectiveness of IPFC

A.V.Naresh babu is with DVR & Dr. HS MIC College of Technology, Kanchikacherla - 521180, Andhra Pradesh, India (corresponding author ; e-mail: avnareshbabu@gmail.com).

S.Sivanagaraju is with Jawaharlal Nehru Technological University, Kakinada, Andhra Pradesh, India. (e-mail: sirigiri70@yahoo.co.in).

model for transient stability analysis through numerical examples and finally, conclusions are given in section VI.

II. MATHEMATICAL MODEL OF IPFC

A. Operating Principle of IPFC

In its general form the inter line power flow controller employs a number of dc-to-ac converters each providing series compensation for a different line. In other words, the IPFC comprises a number of Static Synchronous Series Compensators (SSSC). The simplest IPFC consist of two back-to-back dc-to-ac converters, which are connected in series with two transmission lines through series coupling transformers and the dc terminals of the converters are connected together via a common dc link as shown in Fig.1. With this IPFC, in addition to providing series reactive compensation, any converter can be controlled to supply real power to the common dc link from its own transmission line.

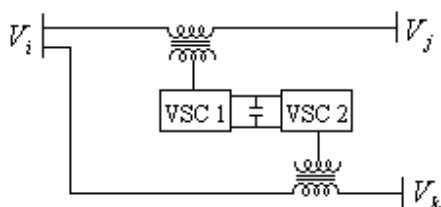

Fig. 1 Schematic diagram of two converter IPFC

B. Mathematical Model of IPFC

In this section, a mathematical model for IPFC which will be referred to as power injection model is derived. This model is helpful in understanding the impact of the IPFC on the power system in the steady state. Furthermore, the IPFC model can easily be incorporated in the power flow model. Usually, in the steady state analysis of power systems, the VSC may be represented as a synchronous voltage source injecting an almost sinusoidal voltage with controllable magnitude and angle. Based on this, the equivalent circuit of IPFC is shown in Fig. 2 [19]-[20].

In Fig.2, V_i, V_j and V_k are the complex bus voltages at the buses i, j and k respectively, defined as $V_m = V_m \angle \theta_m$ ($m=i, j$ and k). Vse_{in} is the complex controllable series injected voltage source, defined as $Vse_{in} = Vse_{in} \angle \theta_{se_{in}}$ ($n=j, k$) and Zse_{in} ($n=j, k$) is the series coupling transformer impedance. The injection model is obtained by replacing the voltage source (Vse_{in}) as current source (Ise_{in}) in parallel with the transmission line. For the sake of simplicity, the resistance of the transmission lines and the series coupling transformers are neglected. Therefore, the current source can be expressed as

$$Ise_{in} = -jbse_{in} Vse_{in} \quad (1)$$

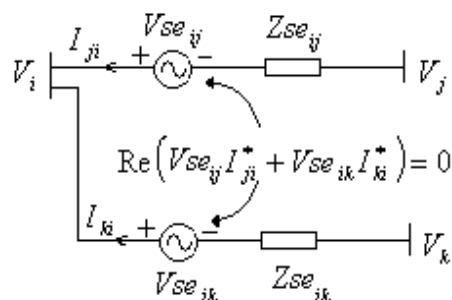

Fig. 2 Equivalent circuit of two converter IPFC

Now, the current source (Ise_{in}) can be modeled as injection powers at the buses i, j and k . The complex power injected at i^{th} bus is

$$S_{inj,i} = \sum_{n=j,k} V_i (-Ise_{in})^* \quad (2)$$

Substitute (1) in (2)

$$S_{inj,i} = \sum_{n=j,k} V_i (jbse_{in} Vse_{in})^* \quad (3)$$

After simplification, the active power and reactive power injections at i^{th} bus are

$$P_{inj,i} = \text{Re}(S_{inj,i}) = \sum_{n=j,k} (V_i Vse_{in} bse_{in} \sin(\theta_i - \theta_{se_{in}})) \quad (4)$$

$$Q_{inj,i} = \text{Im}(S_{inj,i}) = - \sum_{n=j,k} (V_i Vse_{in} bse_{in} \cos(\theta_i - \theta_{se_{in}})) \quad (5)$$

The complex power injected at n^{th} bus ($n=j, k$) is

$$S_{inj,n} = V_n (Ise_{in})^* \quad (6)$$

Substitute (1) in (6)

$$S_{inj,n} = V_n (-jbse_{in} Vse_{in})^* \quad (7)$$

After simplification, the active power and reactive power injections at n^{th} bus are

$$P_{inj,n} = \text{Re}(S_{inj,n}) = -V_n Vse_{in} bse_{in} \sin(\theta_n - \theta_{se_{in}}) \quad (8)$$

$$Q_{inj,n} = \text{Im}(S_{inj,n}) = V_n Vse_{in} bse_{in} \cos(\theta_n - \theta_{se_{in}}) \quad (9)$$

Based on (4), (5), (8), and (9), power injection model of IPFC can be seen as three dependent power injections at buses i, j and k as shown in Fig.3.

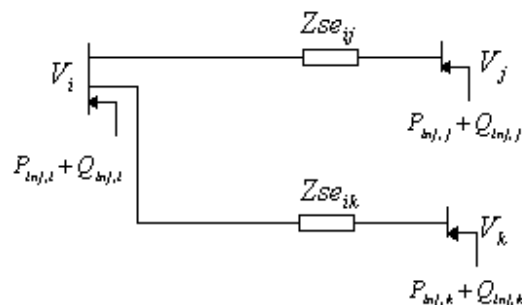

Fig. 3 Power injection model of two converter IPFC

As IPFC neither absorbs nor injects active power with respect to the ac system, the active power exchange between the converters via the dc link is zero, i.e.

$$\operatorname{Re}(V_{se_{ij}} I_{ji}^* + V_{se_{ik}} I_{ki}^*) = 0 \quad (10)$$

Where the superscript * denotes the conjugate of a complex number. If the resistances of series transformers are neglected, (10) can be written as

$$\sum_{m=i,j,k} P_{inj,m} = 0 \quad (11)$$

III. LOCATION OF IPFC

The transient and voltage stability analysis plays an important role for system security and reliability. One of the major recent research areas is the use of FACTS controllers for the co-ordination between transient and voltage stability analysis. So, in this paper, the voltage stability index (L-index) has been used as the basis for selection of suitable locations of IPFC. If n is the total number of buses, g is the number of generator buses and $j=g+1$ to n are the load buses then the L-indices for given load conditions are computed using the load flow results for all the load buses with the following equation

$$L_j = \left| 1 - \sum_{i=1}^g F_{ji} \frac{V_i}{V_j} \right| \quad (12)$$

All the terms with in the sigma on the right-hand side of (12) are the complex quantities. The values of F_{ji} are obtained from the network Y-bus matrix. For the given operating condition,

$$\begin{bmatrix} I_G \\ I_L \end{bmatrix} = \begin{bmatrix} Y_{GG} & Y_{GL} \\ Y_{LG} & Y_{LL} \end{bmatrix} \begin{bmatrix} V_G \\ V_L \end{bmatrix} \quad (13)$$

where I_G, I_L and V_G, V_L represent complex current and voltage vectors for generator and load buses. $[Y_{GG}], [Y_{GL}], [Y_{LL}]$ and $[Y_{LG}]$ are corresponding portions of the network Y-bus matrix. Eq. (13) can be rewritten as

$$\begin{bmatrix} V_L \\ I_G \end{bmatrix} = \begin{bmatrix} Z_{LL} & F_{LG} \\ K_{GL} & Y_{GG} \end{bmatrix} \begin{bmatrix} I_L \\ V_G \end{bmatrix} \quad (14)$$

where $[F_{LG}] = -[Y_{LL}]^{-1}[Y_{LG}]$ and F_{ji} are the complex elements of $[F_{LG}]$ matrix.

Among the various indices for voltage stability and voltage collapse prediction, the L-index gives a scalar number to each load bus and fairly consistent results. The advantage of this method is the simplicity of the numerical calculation and expressiveness of the results. The L-indices for given load conditions are computed for all load buses and the maximum of the L- indices gives the proximity of the system to voltage collapse. If the L-indices for load buses are close to 0(zero), indicating that the system has maximum stability margin and close to 1(unity), indicating that the system approaches to voltage collapse.

IV. SOLUTION METHODOLOGY

For clear reference, the overall solution procedure for transient stability analysis of multi-machine power system network with IPFC is summarized as follows.

Step 1: Input bus data, line data, generator data (transient reactance & inertia constant) and IPFC data (IPFC parameters and its location).

Step 2: Form the bus admittance matrix by inspection method.

Step 3: Obtain power flow solution by Newton-Raphson method.

Step 4: Using power flow solution obtained in step 3, compute the internal machine voltages and also replace all loads by constant shunt admittances.

Step 5: Form the pre-fault, fault-on and post-fault reduced bus admittance matrices.

Step 6: Evaluate the electrical power output of each machine under fault and post-fault conditions.

Step 7: Express multi machine equations in state variable form and also find its solution during fault and post fault conditions.

Step 8: Plot the rotor angle difference and speed difference of each machine with respect to slack bus for different fault clearing times.

Step 9: Repeat steps 2 to 8 with IPFC.

Step 10: Analyze whether system is stable or unstable based on the rotor angle difference curves with out and with IPFC.

The rotor angle difference does not increase indefinitely, and then the system is found to be stable. Otherwise, it is unstable.

Step 11: Repeat the evaluation process for different fault clearing times and predict critical fault clearing time with out and with IPFC.

V. RESULTS AND DISCUSSIONS

In this section, numerical results are carried out on two standard test systems, 6-bus and 11-bus systems [23] to demonstrate the effectiveness and performance of IPFC for transient stability analysis of multi-machine power system network. In 6-bus test system, bus 1 is considered as slack bus, while bus 2 and 3 as generator buses and other buses are load buses. Similarly, in 11-bus system, bus 1 is considered as slack bus, while bus 10 and 11 as generator buses and other buses are load buses. For the test systems, the convergence tolerance is $1e-5$ p.u. System base MVA is 100. At first, the pre-fault power flow solution for the two test systems obtained using standard NR method. The obtained results are compared with the solution given in example 11.7 [23] and observed that the results are exactly matched. Next, the pre-fault power flow solution for the two test systems obtained with IPFC. The pre-fault power flow solutions for two test systems without and with IPFC are given in Table 1 and Table 2 respectively. The pre-fault power flow results are required for transient stability analysis. Further, from Table 1 and Table 2, it is clear that the voltages at slack bus and generator buses are same but there is a significant change in load bus voltages with IPFC. Especially, the voltage at bus-6 of 6-bus system and the voltage at bus-9 of 11-bus system increased to which IPFC converters are connected. The suitable location of IPFC is obtained based on L-index criterion. In this, the L-indices are

computed for all load buses of test system and ranking is given. The maximum of L-index gives the proximity of the system to voltage collapse and ranked as 1(one). So, IPFC placed near to first ranked bus to avoid voltage collapse. The L-indices for the two test systems are given in Table 3 and Table 4 respectively. For 6-bus system, the L-index is more for bus 6. Therefore, one converter of IPFC is embedded in a line between the buses 1-6 which is considered as 1st line and the other converter of IPFC is placed in a line between the buses 4-6 which is considered as 2nd line and bus 6 is selected as common bus for two converters. Similarly, for 11-bus system, the L-index is more for bus 9. Therefore, one converter of IPFC is embedded in a line between the buses 4-9 which is considered as 1st line and the other converter of IPFC is placed in a line between the buses 8-9 which is considered as 2nd line and bus 9 is selected as common bus for two converters. The IPFC location and its parameters for the two test systems are given in Table 5. Finally, the system is examined stable or unstable from the swing curves.

A solid three-phase fault is assumed at a bus in the power system network. A fault in a power system can be either of self-clearing type or it is cleared by line isolation. In this manuscript, it is considered that the fault is cleared by line isolation. Usually, the slack bus is selected as the reference and the phase angle difference of all other generators with respect to the reference machine are plotted. Generally, the solution is carried out for two swings to show that the second swing is not greater than the first one. If the angle differences do not increase, the system is stable and if any of the angle differences increase indefinitely, the system is unstable. Typically, the fault should be cleared as early as possible so that damage on the system can be avoided to a large extent. In this paper, the fault clearing time is increased gradually to find critical clearing time.

The swing curves and rotor speed difference curves of the two test systems for different fault clearing times are shown in Fig.4 to Fig.11. For 6-bus system, it is assumed that a three-phase fault occurs on line 5-6 near bus 6. The variation of generator-2 rotor angle difference without and with IPFC for different fault clearing times is shown in Fig.4. From Fig. 4(a), it is observed that the variation of generator-2 rotor angle difference do not increase indefinitely without and with IPFC for fault clearing time (t_c) =0.4 sec, therefore the system is found to be stable. From Fig. 4(b), it is seen that the variation of generator-2 rotor angle difference increases indefinitely without IPFC, therefore the system is found to be unstable when the fault is cleared in 0.5 sec. But, the variation of generator-2 rotor angle difference do not increase indefinitely with IPFC, therefore the system is found to be stable for the same fault clearing time. Therefore, it can be concluded that the fault clearing time is increased because of IPFC in the system, which indicates the improvement of transient stability margin of the system. From Fig. 4(c), it is also observed that the variation of generator-2 rotor angle difference do not increase indefinitely without IPFC, therefore the system is found to be critically stable when the fault is cleared in 0.45 sec which is near to unstable point. Further, it can be

concluded that the critical clearing time (t_{cc}) for 6-bus system without IPFC is between 0.45 to 0.5 sec. But the t_{cc} is increased with IPFC which is greater than 0.5 sec. The variation of generator-2 rotor speed difference without and with IPFC for different fault clearing times is shown in Fig.5 and it is within the limits for $t_c=0.4$ & $t_c=0.45$ sec without and with IPFC as shown in Fig.5 (a) and 5(c) respectively. But, rotor speed difference increases indefinitely without IPFC and it is within the limits with IPFC when the fault is cleared at $t_c=0.5$ as shown in Fig.5 (b). For the sake of completeness, the variation of generator-3 rotor angle difference and speed difference without and with IPFC for the same fault clearing times are shown in Fig.6 and Fig.7 respectively.

In addition, the same analysis has been carried out for 11-bus system and it is assumed that a three-phase fault occurs on line 3-4 near bus 4. The variation of generator-10 rotor angle difference and speed difference without and with IPFC for different fault clearing times is shown in Fig.8 and Fig.9 respectively. For 11-bus system also, Fig.8 (b) shows that the IPFC improves the system stability, which was otherwise unstable when the fault is cleared in 0.75 sec. For the sake of completeness, the variation of generator-11 rotor angle difference and speed difference without and with IPFC for same fault clearing times is shown in Fig.10 and Fig.11 respectively. Table 6 summarizes the graphical results of 11-bus system along with 6-bus system.

TABLE I
THE PRE FAULT POWER FLOW RESULTS OF 6-BUS SYSTEM WITH OUT AND WITH IPFC

Bus No.	Magnitude of Voltages (p.u)		Angle of Voltages (deg.)		Active Power Generation (MW)		Reactive Power Generation (MVAR)	
	Without IPFC	With IPFC	Without IPFC	With IPFC	Without IPFC	With IPFC	Without IPFC	With IPFC
1	1.060	1.060	0.000	0.000	105.287	103.584	107.335	107.387
2	1.040	1.040	1.470	1.399	150.000	150.000	99.771	102.135
3	1.030	1.030	0.800	0.986	100.000	100.000	35.670	29.290
4	1.008	1.007	-1.401	-1.475	0.000	0.000	0.000	0.000
5	1.016	1.019	-1.499	-1.308	0.000	0.000	0.000	0.000
6	0.941	0.958	-5.607	-5.068	0.000	0.000	0.000	0.000

TABLE II
THE PRE FAULT POWER FLOW RESULTS OF 11-BUS SYSTEM WITH OUT AND WITH IPFC

Bus No.	Magnitude of Voltages (p.u)		Angle of Voltages (deg.)		Active Power Generation (MW)		Reactive Power Generation (MVAR)	
	Without IPFC	With IPFC	Without IPFC	With IPFC	Without IPFC	With IPFC	Without IPFC	With IPFC
1	1.040	1.040	0.000	0.000	246.646	244.903	206.451	206.510
2	1.028	1.028	-0.793	-0.787	0.000	0.000	0.000	0.000
3	0.997	0.997	-1.970	-1.938	0.000	0.000	0.000	0.000
4	1.024	1.024	-0.608	-0.530	0.000	0.000	0.000	0.000
5	1.017	1.017	-1.318	-1.317	0.000	0.000	0.000	0.000
6	0.993	0.993	-2.277	-2.254	0.000	0.000	0.000	0.000
7	1.021	1.021	-0.348	-0.358	0.000	0.000	0.000	0.000
8	0.985	0.984	-2.414	-2.434	0.000	0.000	0.000	0.000
9	0.981	1.014	-2.798	-1.738	0.000	0.000	0.000	0.000
10	1.035	1.035	0.257	0.335	200.000	200.000	141.499	138.056
11	1.030	1.030	0.524	0.514	160.000	160.000	95.095	95.293

TABLE III
L-INDICES OF 6-BUS SYSTEM

Bus No.	L-Index	Rank
6	0.164	1
4	0.059	2
5	0.046	3

TABLE IV
L-INDICES OF 11-BUS SYSTEM

Bus No.	L-Index	Rank
9	0.079	1
8	0.071	2
6	0.063	3
3	0.056	4
5	0.033	5
4	0.019	6
2	0.018	7
7	0.017	8

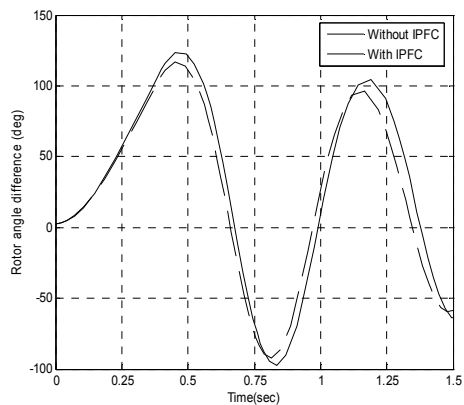

(a)

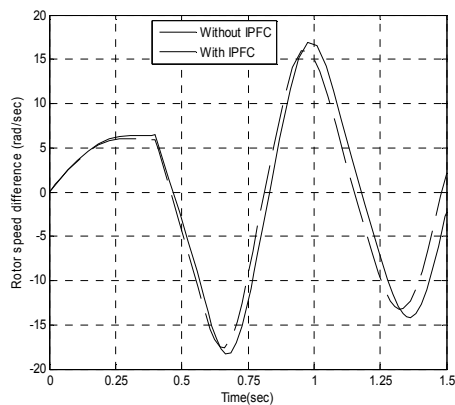

(a)

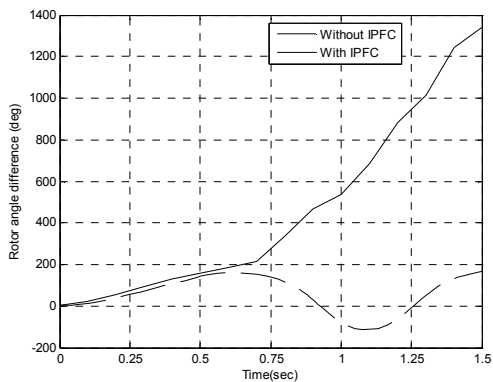

(b)

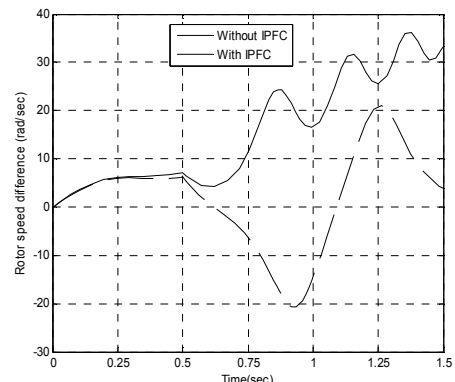

(b)

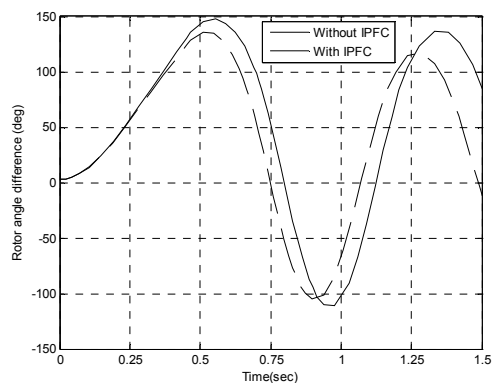

(c)

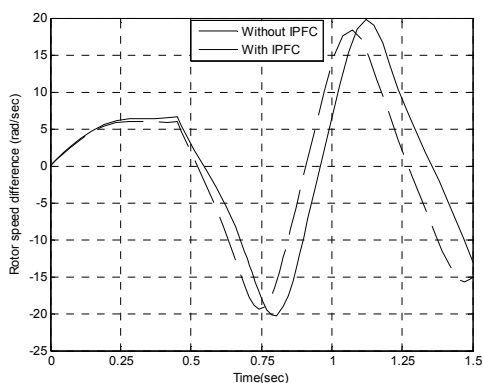

(c)

Fig. 4 Variation of generator – 2(6 bus system) rotor angle difference without and with IPFC for different fault clearing times(t_c), (a) $t_c = 0.4$ (b) $t_c = 0.5$ (c) $t_c = 0.45$

Fig. 5 Variation of generator – 2(6 bus system) rotor speed difference without and with IPFC for different fault clearing times(t_c), (a) $t_c = 0.4$ (b) $t_c = 0.5$ (c) $t_c = 0.45$

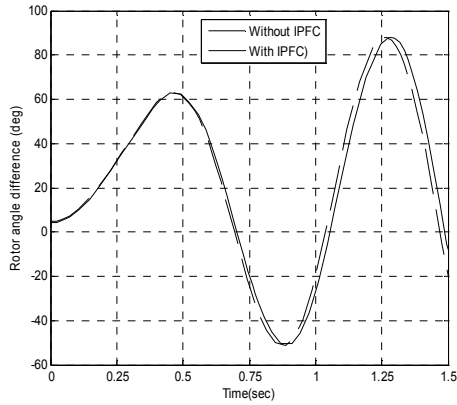

(a)

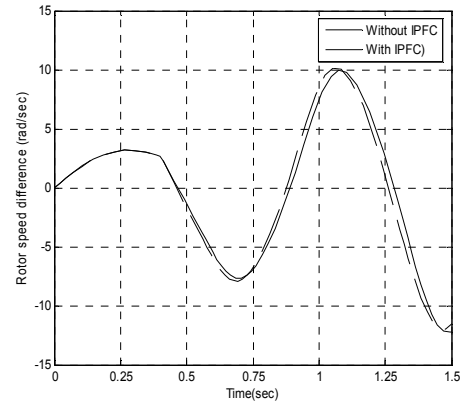

(a)

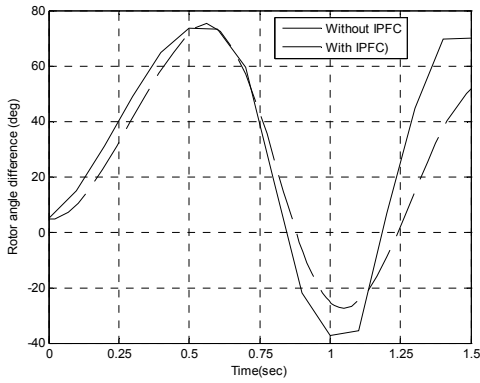

(b)

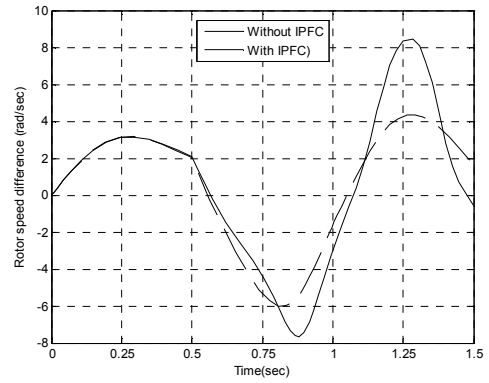

(b)

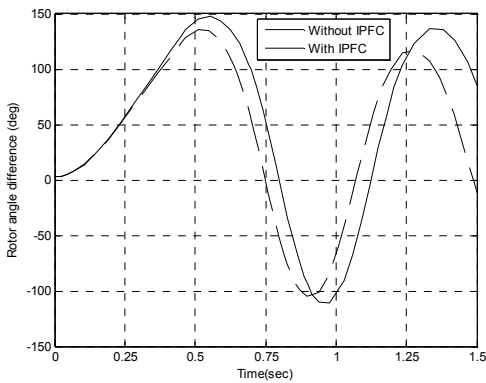

(c)

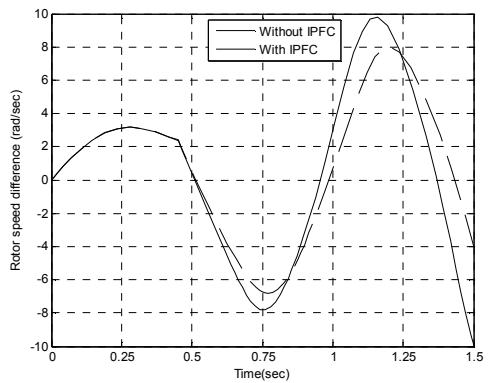

(c)

Fig. 6 Variation of generator – 3(6 bus system) rotor angle difference without and with IPFC for different fault clearing times(t_c), (a) $t_c = 0.4$ (b) $t_c = 0.5$ (c) $t_c = 0.45$

Fig. 7 Variation of generator – 3(6 bus system) rotor speed difference without and with IPFC for different fault clearing times(t_c), (a) $t_c = 0.4$ (b) $t_c = 0.5$ (c) $t_c = 0.45$

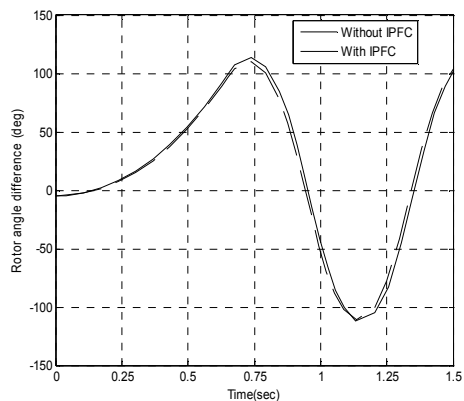

(a)

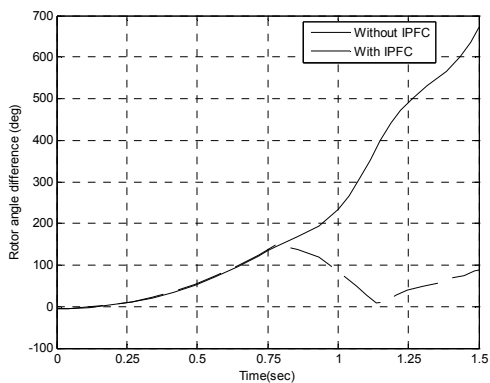

(b)

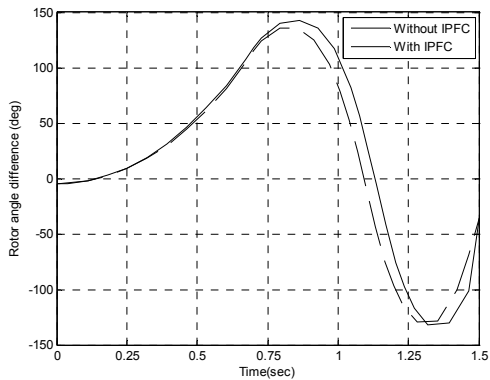

(c)

Fig. 8 Variation of generator – 10(11 bus system) rotor angle difference without and with IPFC for different fault clearing times(t_c), (a) $t_c=0.65$ (b) $t_c=0.75$ (c) $t_c=0.7$

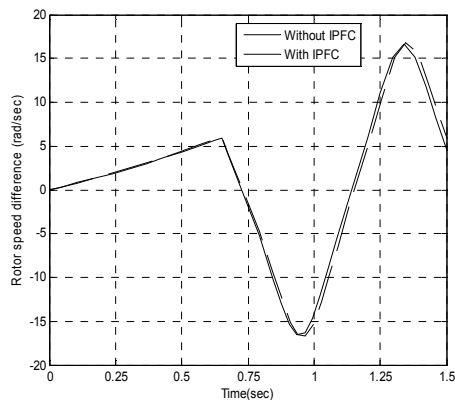

(a)

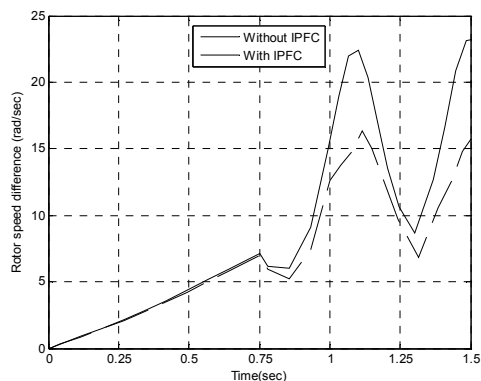

(b)

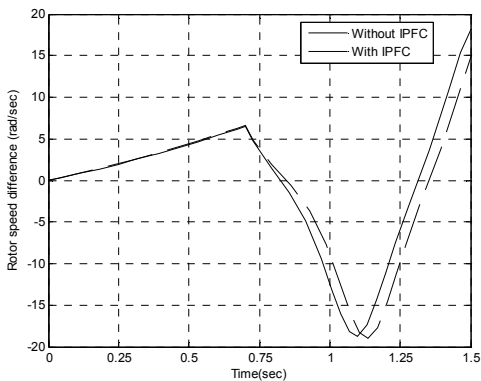

(c)

Fig. 9 Variation of generator – 10(11 bus system) rotor speed difference without and with IPFC for different fault clearing times(t_c), (a) $t_c=0.65$ (b) $t_c=0.75$ (c) $t_c=0.7$

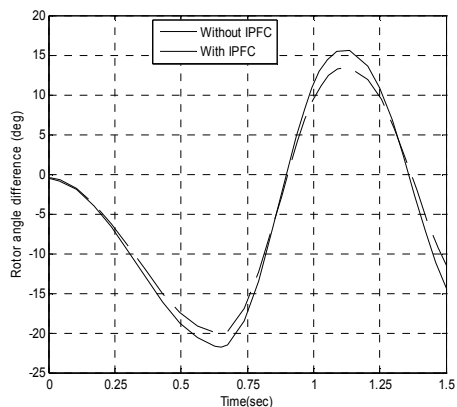

(a)

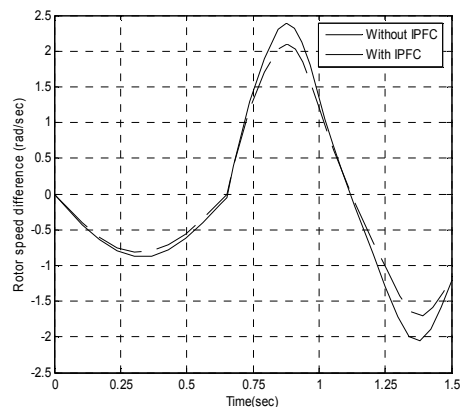

(a)

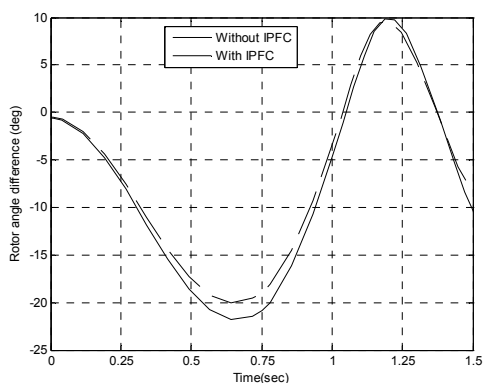

(b)

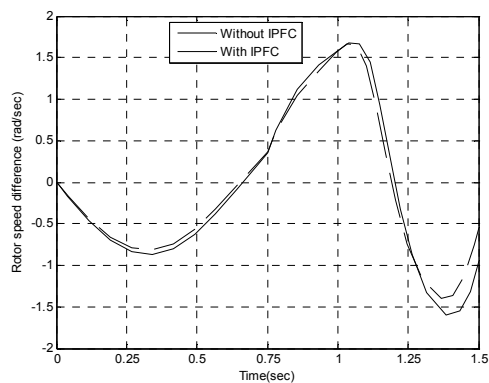

(b)

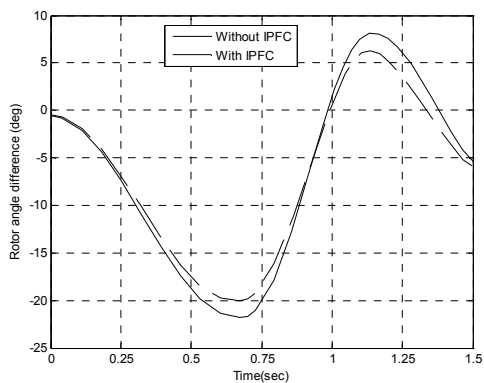

(c)

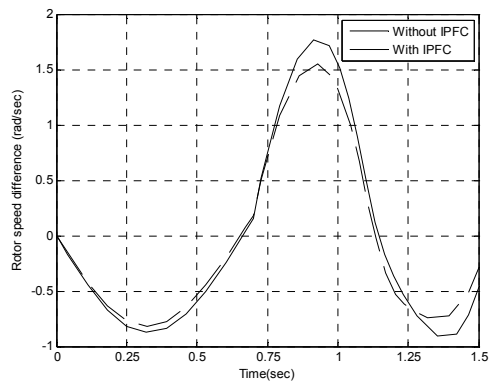

(c)

Fig. 10 Variation of generator – 11(11 bus system) rotor angle difference without and with IPFC for different fault clearing times(t_c), (a) $t_c=0.65$ (b) $t_c=0.75$ (c) $t_c=0.7$

Fig. 11 Variation of generator – 11(11 bus system) rotor speed difference without and with IPFC for different fault clearing times(t_c), (a) $t_c=0.65$ (b) $t_c=0.75$ (c) $t_c=0.7$

TABLE V
IPFC LOCATION AND PARAMETERS

Test system	IPFC Location		IPFC Parameters	
	Bus No.	Lines	Vse (p.u)	θ_{se} (deg)
6 - bus	6	1-6 & 4-6	0.03	-150
11- bus	9	4-9 & 8-9	0.04	-150

TABLE VI
STATUS OF TEST SYSTEMS WITH OUT AND WITH IPFC FOR DIFFERENT FAULT CLEARING TIMES

Test system	Faulted bus	Line removed to clear fault	Fault clearing time, t_c (sec.)	Status of system		Critical clearing time, t_{cc} (sec.)	
				without IPFC	with IPFC	without IPFC	with IPFC
6- bus	6	5 - 6	0.4	stable	stable		
			0.45	critically stable	stable	$0.45 \leq t_{cc} < 0.5$	≥ 0.5
			0.5	unstable	stable		
11- bus	4	3 - 4	0.65	stable	stable		
			0.7	critically stable	stable	$0.7 \leq t_{cc} < 0.75$	≥ 0.75
			0.75	unstable	stable		

VI. CONCLUSION

In this paper, a multi-line flexible alternating current transmission system (FACTS) controller which is interline power flow controller (IPFC) has been addressed. The power injection model of IPFC along with Newton-Raphson (NR) power flow solution method has been used to plot swing curves for transient stability analysis of a multi-machine power system network. Numerical results on the test systems have demonstrated the feasibility and effectiveness of the IPFC model. The placement of the IPFC, based on L-index is found to be beneficial for system stability. It is shown that, there is an increase in load bus voltages to which IPFC converters are connected and the peak of first swing of the swing curve can be reduced significantly with IPFC for both the test systems. Further, a system without IPFC becomes unstable when the fault duration exceeds the critical clearing time. However, the IPFC in suitable location with chosen parameters may help the system to remain stable even under those conditions i.e. the fault clearing time is increased with IPFC which indicates the improvement of transient stability margin of the system. The strong multi-line control capability of IPFC plays an important role in power systems and is also a useful tool for planning, operation and control of power systems.

REFERENCES

- [1] N.G.Hingorani and L.Gyugyi, "Understanding FACTS-Concepts and Technology of Flexible AC Transmission Systems," IEEE press, First Indian Edition, 2001.
- [2] P.Kundur, "Power System Stability and Control," McGraw Hill, 1994.
- [3] R.Mihalic,P.Zunko and D.Povh, "Improvement of transient stability using unified power flow controller," IEEE Trans. Power Del., vol.11, no.1, pp.485-492, Jan.1996.
- [4] U.Gabrijel and R.Mihalic, "Direct methods for transient stability assessment in power systems comprising controllable series devices," IEEE Trans. Power Syst., vol.17, no.4, pp.1116-1122, Nov.2002.
- [5] R.Mihalic and U.Gabrijel, "A structure-preserving energy function for a static series synchronous compensator," IEEE Trans. Power Syst., vol.19, no.3, pp.1501-1507, Aug.2004.
- [6] V.Azbe,U.Gabrijel, D.Povh and R.Mihalic,"The energy function of a general multimachine system with a unified power flow controller," IEEE Trans. Power Syst., vol.20, no.3, pp.1478-1485, Aug.2005.
- [7] Haque M.H., "Effects of exact line model and shunt FACTS devices on first swing stability limit," Int. J. Power Energy Syst., vol.25, no.2, pp. 121- 127, 2005.
- [8] H.Chen,Y.Wang and R.Zhou, "Transient and voltage stability enhancement via co-ordinated excitation and UPFC control," IEE Proc.-Gener.Transm.Distrib., vol.148, no.3, pp.201-208, May 2001.
- [9] S.Abazari, J.Mahdavi ,H.Mokhtari and A.Emadi, "Transient stability improvement by using advanced static VAR compensators," Electric Power Components and Syatems,vol.31,pp.321-334,2003.
- [10] M.H.Haque, " Improvement of first swing stability limit by utilizing full benefit of shunt FACTS devices," IEEE Trans. Power Syst., vol.19, no.4, pp.1894-1902, Nov. 2004.
- [11] Dheeman Chatterjee and Arindam Ghosh, "TCSC control design for transient stability improvement of a multi-machine power system using trajectory sensitivity," Electrical. Power Systems Research, vol. 77 , pp. 470-483, 2007.

- [12] M.S.Castro,H.M.Ayres,V.F.da Costa and L.C.P.da silva, "Impacts of the SSSC control mode on small-signal and transient stability of a power system," *Electric Power Systems Research*, vol. 77 , pp. 1-9, 2007.
- [13] S.Panda and R.N.Patel, " Optimal location of shunt FACTS controllers for transient stability improvement employing genetic algorithm," *Electric Power Components and Systems*, vol.35, no.2,pp.189– 203, 2007.
- [14] N.Mo,Z.Y.Zou,K.W Chan and T.Y.G.Pong," Transient stability constrained optimal power flow using particle swarm optimisation," *IET Gener.Transm.Distrib.*, vol.1, no.3,pp.476-483, May 2007.
- [15] H.R.Cai,C.Y.chung and K.P Wong, "Application of differential evolution algorithm for transient stability constrained optimal power flow," *IEEE Trans. Power Systems*, vol.23, no.2, pp.719–728, May 2008.
- [16] Lei Chen,Yong Min,Fei Xu and Kai-Peng Wang, "A Continuation – based method to compute the relevant unstable equilibrium points for power system transient stability analysis," *IEEE Trans. Power Systems*, vol.24, no.1, pp.165–172, Feb. 2009.
- [17] Quanyuan Jiang and Guangchao Geng, "A Reduced –space interior point method for transient stability constrained optimal power flow," *IEEE Trans. Power Systems*, vol.25, no.3, pp.1232–1240, Aug. 2010.
- [18] Quanyuan Jiang and Zhiguang Huang, "An enhanced numerical discretization method for transient stability constrained optimal power flow," *IEEE Trans. Power Systems*, vol.25, no.4, pp.1790–1797, Nov. 2010 .
- [19] A.V.Naresh Babu, S.Sivanagaraju, Ch.Padmanabharaju and T.Ramana" Power flow analysis of a power system in the presence of interline power flow controller(IPFC)," *ARPN Journal of Engineering and Applied Sciences*, vol.5, no.10,pp.1-4, Oct. 2010.
- [20] A.V.Naresh Babu and S.Sivanagaraju,"Mathematical modelling,analysis and effects of interline power flow controller(IPFC) parameters in power flow studies," 4th IEEE- India Int. Conf. on Power Electronics, New Delhi, India, Jan. 2011.
- [21] D.Thukaram and A.Lomi, "Selection of static VAR compensator location and size for system voltage stability improvement," *Electric Power Systems Research*, vol. 54 , pp. 139-150, 2000.
- [22] D.Thukaram, L.Jenkins and K.Visakha," Improvement of system security with unified power flow controller at suitable locations under network contingencies of interconnected systems," *IEE Proc.-Gener.Transm.Distrib.*, vol.152, no.5, pp.682-690, Sep.2005.
- [23] H.Saadat," *Power System Analysis*," Tata McGraw-Hill Edition, 2002.

A.V.Naresh Babu received his B.Tech in electrical and electronics engineering from RVR&JC CE, Andhra Pradesh, India, in 2003 and M.Tech in power systems from Jawaharlal Nehru Technological University-Kakinada, Andhra Pradesh, India, in 2007.He is currently pursuing Ph.D from the department of electrical & electronics engineering, Jawaharlal Nehru Technological University-Kakinada. He is presently Associate Professor in the department of electrical and electronics engineering at DVR &Dr. HS MIC College of Technology. His research interests include FACTS technology, power electronics applications to power systems and Optimization Techniques.

S.Sivanagaraju received his B.Tech in electrical and electronics engineering from Andhra University, Andhra Pradesh, India in 1998, M.Tech in electrical power systems from Indian Institute of Technology (IIT), Khargpur, West Bengal, India in 2000 and Ph.D in Electrical and Electronics Engineering from Jawaharlal Nehru Technological University-Hyderabad, AndhraPradesh, India in 2004. Dr.S.Sivanagaraju is currently Associate Professor in the department of electrical engineering at Jawaharlal Nehru Technological University-Kakinada. He received two National awards (Pandit Madan Mohan Malaviya memorial prize award and best paper prize award) from the Institute of Engineers(India) for the year 2003-2004.His research interests include FACTS technology, Distribution Systems automation and genetic algorithm applications to Power Systems .