

VoIP Source Model based on the Hyperexponential Distribution

Arkadiusz Biernacki

Abstract—In this paper we present a statistical analysis of Voice over IP (VoIP) packet streams produced by the G.711 voice coder with voice activity detection (VAD). During telephone conversation, depending whether the interlocutor speaks (ON) or remains silent (OFF), packets are produced or not by a voice coder. As index of dispersion for both ON and OFF times distribution was greater than one, we used hyperexponential distribution for approximation of streams duration. For each stage of the hyperexponential distribution, we tested goodness of our fits using graphical methods, we calculated estimation errors, and performed Kolmogorov-Smirnov test. Obtained results showed that the precise VoIP source model can be based on the five-state Markov process.

Keywords—VoIP source modelling, distribution approximation, hyperexponential distribution.

I. INTRODUCTION

SPEECH is a basic medium of communication between humans. The traditional telephony based on analogue technologies is rapidly losing a market share as the telephony based on packet networks is gaining strength. The latter is expected to continue its growth both in corporate networks as well as in public ones. Consequently, voice packets produced during telephone conversations are to have considerable share in all voice packets sent through networks. Proper quality of service assurance for IP based network transporting packetized voice (VoIP) requires knowledge of data characteristics, which are sent through this network. A VoIP conversation, like traditional telephony conversation, can be considered as an alternate process during which one of interlocutors is speaking and the other one is listening. Moreover, the speaking interlocutor often makes small gaps between spoken phrases, words and syllables. Aforementioned characteristics of a conversation and the human voice are used by a voice coder with voice activity detector (VAD), which detects frames containing silence and suspends them from further emission through packet network, Fig. 1. Besides, voice in a coder is also compressed. The above mentioned operations allow for bandwidth consumption reduction in packet network transporting VoIP packets.

In order to guarantee quality of service for a user and simultaneously take full advantage of available network

Arkadiusz Biernacki is with the Institute of Computer Science, Silesian University of Technology, Akademicka 16, 44-100 Gliwice, Poland (e-mail: arkadiusz.biernacki@polsl.pl).

bandwidth, it is necessary to determine its utilization distribution during conversation. Researches, which try to determine this distribution, need a proper VoIP source model, whose key elements are: distribution of time when interlocutor speaks (ON) and distribution of time when interlocutor remains silent (OFF).

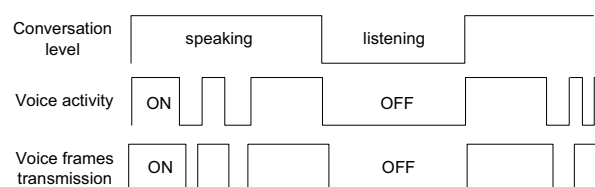

Fig. 1 Correspondence between conversation levels and packet generation by a voice coder

To facilitate construction of analytically tractable VoIP source model, for approximation of the ON/OFF times we chose family of matrix exponential distribution, which is very powerful and has useful properties that allow it to be used in the construction of general analytic models [1].

The rest of this paper is organized as follows: in section II we described the previous researches in the field of determining telephone conversation statistics. In section III we presented an experiment we conducted and in section IV we gave basic statistics of measured data. In section V we gave theoretical basis of hyperexponential distribution and fitting process. Goodness of fit is graphically analysed in section VI and mathematical analysis is presented in section VII. In VIII we proposed a VoIP source model based on Markov process. Section IX is a conclusion of our work.

II. PREVIOUS WORKS

First experiments concerning the voice ON/OFF times distribution were conducted in Bell laboratories in the sixties of the previous century, and the voice source was assumed to be a simple two-state Markov model [2, 3]. Further research showed that this model is inadequate and OFF times are not exponentially distributed [4]. Thorough investigation conducted in [5] proved ON/OFF times to be exponentially distributed only in rough approximation whose quality heavily depends on silence detection delay which was a parameter of a voice coder. F. Barcelo found OFF periods to be distributed hyperexponentially with two stages [6]. In [7] the influence of NeVoT Silence Detector [8] and the silence detector

implemented in G.729 coder on ON/OFF times distribution was analysed. Researches confirmed that these distribution deviate from the exponential one. In [9] authors showed that the ON/OFF distribution is logarithmic-normal and independent from a voice coder used when the analyzed streams were produced by a coder with 0.1 s silence detection delay. Authors of the researches conducted in [10] stated, that the ON/OFF times are suitably modelled by the gamma and Weibull distributions respectively, whereas in [11] it was proved that both these times are Pareto distributed. Pareto and Weibull distribution for the ON/OFF times were proposed in [12].

Despite its inadequacy, the model based on two-state Markov process is often used for performance estimation of the packetized voice, for example [13, 14]. It is mainly the result of its computational simplicity.

III. EXPERIMENT

With the use of Windows Sound Recorder, we recorded one side of several real phone conversations, which were held by using popular VoIP software, and their cumulative duration exceeded ten hours. Then, we connected two computers equipped with OpenH323 library [15] with Ethernet cable. Previously recorded conversations were played and, encoded by voice coders, were sent through the network to the second computer, where we recorded the timestamps of the voice packets using *Ethereal* software [16]. On the base of the recorded timestamps we calculated the ON/OFF time periods, and afterwards, we analysed them in Matlab.

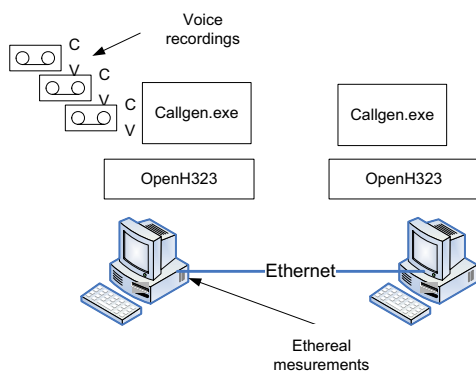

Fig. 2 The facility designed for VoIP streams measurements

IV. BASIC STATISTICS

Basic statistics of measured ON/OFF times are presented in Table I. Index of dispersion, $C_X^2 = \text{Var}[X]/E[X]^2$, where $E[X]$ and $\text{Var}[X]$ denote the mean and variance of the data, is significantly higher than for the ON periods and indicates high variability of the distribution. Analyzing quintiles for the OFF distribution, we stated that about half of all gaps in a VoIP stream are very short and their duration is shorter than 0.3 s. Histograms for the ON and OFF times are presented on Fig. 3 and Fig. 4 respectively.

TABLE I
 ON/OFF TIME STATISTICS

Statistics	E[X]	Var[X]	C_X^2	Quantiles		
				25%	50%	75%
Time [s]						
ON	1.65	3.70	1.36	0.47	1.03	2.12
OFF	1.10	5.65	4.67	0.07	0.30	0.92

E[X] – mean Var[X] – variation C_X^2 – index of dispersion

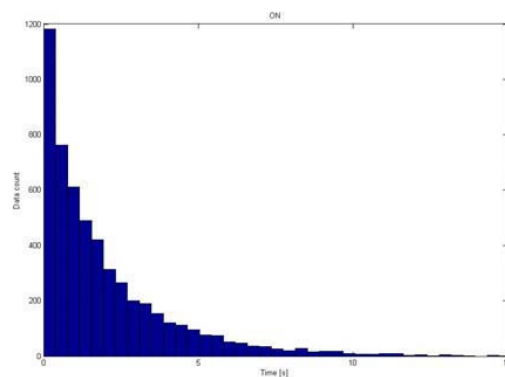

Fig. 3 Histogram of ON times

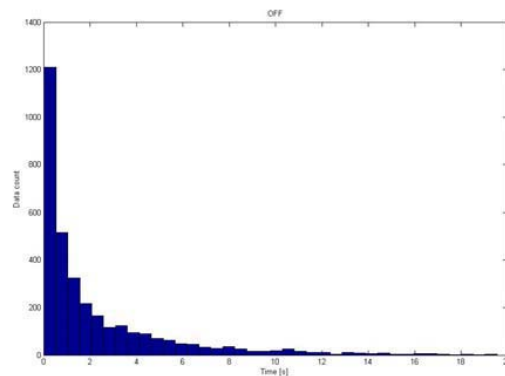

Fig. 4 Histogram of OFF times

V. DISTRIBUTION FITTING

As it was presented in Table I, the index of dispersion C_X^2 for both the ON and OFF periods is higher than one. In this case, from the families of matrix exponential distribution, the hyperexponential one is suitable for the data approximation.

A. Hyperexponential Distribution

The hyperexponential (HP- m) distribution is characterized by the number of the exponential phases m , and associated with each phase mean μ_i and probability p_i . The HP distribution $H_m(x)$ has $2n-1$ parameters, and its density function is given by the formula:

$$H_m(x) = \sum_{j=1}^m p_j \mu_j \exp(-\mu_j x) \quad (1)$$

It has the following interpretation: a job enters a service facility and chooses a service station with probability p_i . The service time on each station is exponentially distributed with the mean μ_i . Example of this interpretation for H_2 distribution is given on Fig. 5.

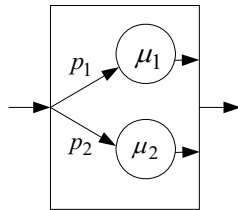

Fig. 5 H_2 service facility

B. Fitting Procedure

Parameters for the HP distribution were computed by the maximum likelihood estimation method, which begins with writing a mathematical expression known as the likelihood function of sample data. The likelihood of data set is the probability of obtaining particular set of data, given the chosen probability distribution model. This expression contains the unknown model parameters. The values of these parameters that maximize the sample likelihood are known as the Maximum Likelihood Estimator (MLE). However, the MLE estimates for a phase-type distribution are difficult to derive, so we used an iterative technique, the expectation-maximization (EM) algorithm [17]. Each iteration of the algorithm has alternate stages. The first stage is the computation of the expected value of the likelihood function conditioned by the observed data as a function of an unknown parameter (E-step). The second stage is the maximization of the likelihood function over some parametric space (M-step). Computations were conducted with EMpht program [18], which is a universal tool for fitting matrix exponential distributions. Obtained parameters were presented in Appendix in Table III.

VI. GRAPHICAL ANALYSIS

We used two graphical techniques for distribution goodness of fit estimation: quantile-quantile and probability-probability plots. The first one plots the quantiles of the empirical ON/OFF data set against the quantiles of the HP distribution generated data set. By a quantile we mean the fraction (or percent) of points below a given value. The second one plots probability of the empirical ON/OFF data set against the probabilities of the HP distribution generated values in a logarithmic scale of the y-axis, and we used it for evaluation of the distribution right tail.

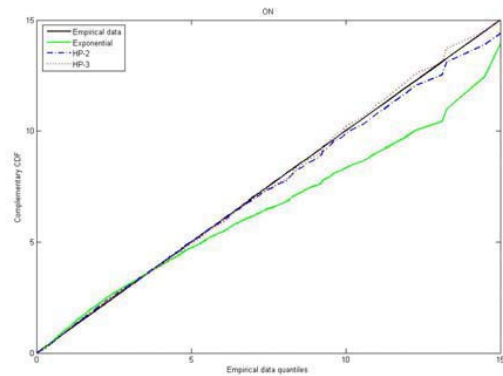

Fig. 6 Quantile-quantile plot for the distribution of the ON times adjusted to the HP distribution

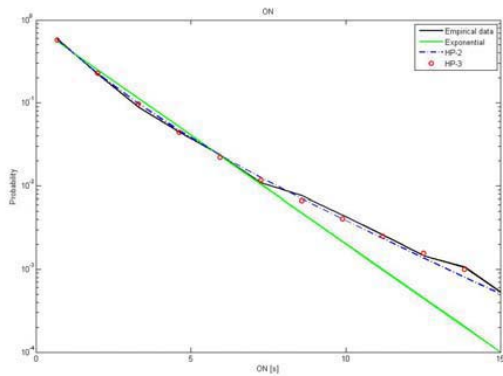

Fig. 7 Probability-probability plot for the distribution of the ON times adjusted to the HP distribution

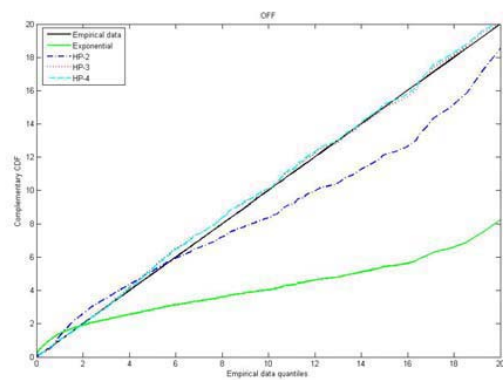

Fig. 8 Quantile-quantile plot for the distribution of the OFF times adjusted to the HP distribution

The HP-2 distribution is a good fit for the ON times, Fig. 6 and Fig. 7, while the HP-3 does not reduce the estimation error significantly. The OFF periods are optimally fitted by the HP-3, Fig. 8 and Fig. 9. The increase of the distribution stage does not improve the fit.

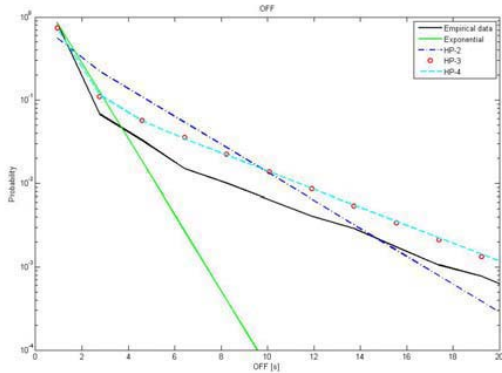

Fig. 9 Probability-probability plot for the distribution of the OFF times adjusted to the HP distribution

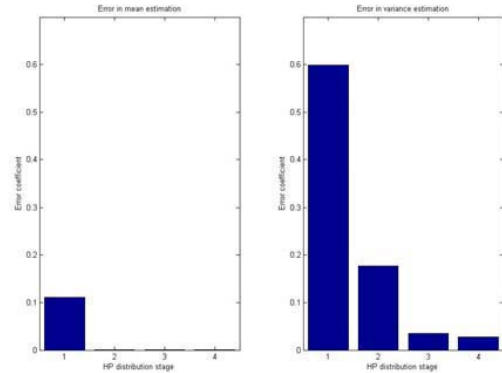

Fig. 11 Errors in the mean and variance estimation for the OFF times

VII. GOODNESS OF FIT ESTIMATION

A. Errors in Mean and Variance

We computed errors, made by the PH distribution in the mean and variance estimation, while approximating the ON/OFF times distribution. We used the following formulas:

$$Er_{\text{mean}} = \frac{|E[X] - E[\hat{X}]|}{E[X]} \quad \text{and} \quad Er_{\text{var}} = \frac{|\text{Var}[X] - \text{Var}[\hat{X}]|}{\text{Var}[X]}$$

where $E[X]$ and $\text{Var}[X]$ denote the mean and variance of the empirical data and $E[\hat{X}]$ and $\text{Var}[\hat{X}]$ denote the mean and variance of the fitted distributions. We presented the results of the above formulas on Fig. 10 and Fig. 11 for the ON and OFF times respectively. For the ON times the estimation error stabilized while using the HP-2 or higher stage, for the OFF times the stabilization was reached by the HP-3.

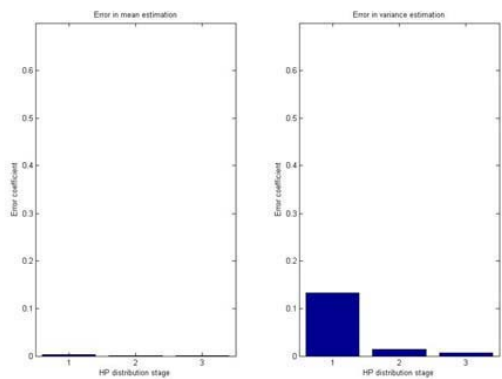

Fig. 10 Errors in the mean and variance estimation for the ON times

B. Kolmogorov-Smirnov Test

The Kolmogorov-Smirnov test (KS-test) tries to determine if two datasets differ significantly [19]. The KS-test is non-parametric and distribution free. It compares an empirical distribution function with a cumulative distribution function specified by a null hypothesis. P-values report if these distributions differ significantly. The higher the p-values are, the greater the probability for the examined datasets coming from the same distribution is. P-values for the ON/OFF times approximation by different stages of the HP distribution were presented in Table II.

TABLE II
P-VALUES FOR KOLMOGOROV-SMIRNOV TEST

Distribution	HP-1	HP-2	HP-3	HP-4
Time				
ON	0	0.26	0.31	×
OFF	0	0.09	0.52	0.51

VIII. VOIP SOURCE MODEL

Taking into account our analysis conducted in the former sections, we proposed five-state Markov based source model for a VoIP source using a coder equipped with VAD, Fig. 12. The model has two ON and three OFF states, and alternates between both ON/OFF groups.

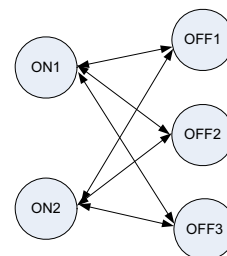

Fig. 12 Markov based VoIP source model

IX. CONCLUSIONS

We studied ON/OFF times distribution of voice streams produced by a coder equipped with a voice activity detector. We fitted the hyperexponential distributions to the ON/OFF patterns. We evaluated our fits with graphical methods and we estimated fits errors using mathematical calculations and Kolmogorov-Smirnov test. We stated that the ON times are best approximated by the two-stage HP distribution, whereas for the OFF times the best approximation is made by three-stage HP distribution. We proposed five-state Markov based VoIP source model for a voice coder equipped with voice activity detector.

APPENDIX – PARAMETER VALUES

TABLE III
 OBTAINED PARAMETERS FOR HP DISTRIBUTIONS

Distribution	HP-1	HP-2	HP-3	HP-4	
Time					
ON	p_j	1	0.63	0.10	
			0.37	0.21	
			0.69	×	
	μ_j	0.60	0.85	0.77	
OFF	p_j		0.40	0.33	
				0.77	×
	μ_j	1	0.64	0.50	0.36
			0.36	0.20	0.15
		0.30	0.30		
			0.19		
OFF	p_j	1.05	5.29	1.83	2.10
			0.38	0.25	1.22
	μ_j			19.68	19.80
					0.24

REFERENCES

[1] K. Mitchell, J. Place, and A. Liefvoort, "Analytic Modeling with Matrix Exponential Distributions," A Simulation Councils Proceedings Series, vol. 28, 1996.
 [2] P. T. Brady, "A technique for investigating on-off patterns of speech," Bell System Technical Journal, vol. 44, pp. 1-22, 1965.
 [3] P. T. Brady, "A statistical analysis of on-off patterns in 16 conversations," Bell System Technical Journal, vol. 47, pp. 73-91, 1968.
 [4] P. T. Brady, "A model for generating ON-OFF speech patterns in two-way conversation," Bell System Technical Journal, vol. 48, pp. 2445-2472, 1969.
 [5] J. Gruber, "A Comparison of Measured and Calculated Speech Temporal Parameters Relevant to Speech Activity Detection," Communications, IEEE Transactions on [legacy, pre - 1988], vol. 30, pp. 728-738, 1982.
 [6] F. Barcelo, "Statistical properties of silence gap in public mobile telephony channels with application to data transmission," presented at IEEE International Conference on Communications, (ICC 2001), Helsinki, 2001.
 [7] J. Wenyu and H. Schulzrinne, "Analysis of on-off patterns in VoIP and their effect on voice traffic aggregation," 2000.
 [8] H. Schulzrinne, "Voice Communication Across The Internet: A Network Voice Terminal," Dept. of Computer Science, University of Massachusetts, Amherst TR 92-50, 1992.
 [9] E. Casilari, H. Montes, and I. F. Sandova, "Modelling of Voice Traffic Over IP Networks," presented at 3rd International Symposium on Communication Systems, Networks and Digital Signal Processing (CSNDPS 2002), Stafford 2002.
 [10] B. Bellalte, M. Oliver, and D. Rincon, "Capacity and traffic analysis of voice services over GPRS mobile networks," Technical University of Catalonia, University Pompeu Fabra 2002.

[11] T. D. Dang, B. Sonkoly, and S. Molnár, "Fractal Analysis and Modelling of VoIP Traffic," presented at NETWORKS 2004, Vienna, Austria, 2004.
 [12] A. Biernacki, "Statistical analysis of VoIP streams (available in Polish only)," presented at 7th Conference „Internet – Wrocław 2005”, Wrocław, 2005.
 [13] N. Blefari-Melazzi, J. Daigle, and N. M. Femminella, "Stateless Admission Control for QoS Provisioning for VoIP in a DiffServ Domain," presented at ITC 18th, Berlin, 2003.
 [14] M. Narbutt and L. Murphy, "VoIP Payout Buffer Adjustment using Adaptive Estimation of Network Delays," presented at 18th International Teletraffic Congress (ITC-18), 2003.
 [15] Vox-Gratia, "OpenH323," 2005.
 [16] E. S. Inc., "Ethereal, A Network Protocol Analyzer," 2005.
 [17] S. Asmussen, O. Nerman, and M. Olsson, "Fitting phase-type distributions via the EM algorithm," Scandinavian Journal of Statistics, pp. 419-441, 1996.
 [18] O. Haggstrom, S. Asmussen, and O. Nerman, "EMPHT – a program for fitting phase-type distributions," Technical report, Department of Mathematics, Chalmers University of Technology, Goteborg 1992.
 [19] R. B. D'Agostino and M. A. Stephens, Goodness-of-Fit Techniques: Marcel Dekker, 1986.