

The Influence of the Commons Structure Modification on the Active Power Losses Allocation

O. Pop, C. Barbulescu, M. Nemes, and St. Kilyeni

Abstract—The tracing methods determine the contribution the power system sources have in their supplying. These methods can be used to assess the transmission prices, but also to recover the transmission fixed cost. In this paper is presented the influence of the modification of commons structure has on the specific price of transfer and on active power losses. The authors propose a power losses allocation method, based on Kirschen's method. The system operator must make use of a few basic principles about allocation. The only necessary information is the power flows on system branches and the modifications applied to power system buses. In order to illustrate this method, the 25-bus test system is used, elaborated within the Electrical Power Engineering Department, from Timisoara, Romania.

Keywords—Power systems, P-U bus, P-Q bus, loss allocation, traceability methods.

I. INTRODUCTION

IN the latest years, the electric power systems suffered several restructuring processes, having as a goal to establish competition. The restructuring process requires a large number of difficult problems to be solved. But, the most significant problem is to establish an efficient method for transmission cost assessment. Following this direction, several questions must be clarified:

- Which is the active and reactive power path in its flow from a generator unit, through a consumer, taking into consideration a certain power system structures?
- How the generated powers are quantitatively allocated to the individual consumers?
- How the electric energy transfer costs are allocated to the system buses?
- How much are the active energy losses and who pays for them?

Manuscript received April 28, 2008.

O. Pop, is with "Politehnica" University of Timisoara, RO-300223 Romania (phone: +40-256-403430; fax: +40-256-403416; e-mail: oana.pop@et.upt.ro).

C.Barbulescu, is with "Politehnica" University of Timisoara, RO-300223 Romania (phone: +40-256-403430; fax: +40-256-403416; e-mail: constantin.barbulescu@et.upt.ro).

M. Nemes is with "Politehnica" University of Timisoara, RO-300223 Romania (phone: +40-256-403407; fax: +40-256-403416; e-mail: mircea.nemes@et.upt.ro).

St. Kilyeni, is with "Politehnica" University of Timisoara, RO-300223 Romania (phone: +40-256-403416; fax: +40-256-403416; e-mail: stefan.kilyeni@et.upt.ro).

Beginning with the apparition of the restructuring process, several allocating methods have been developed. This fact should not surprise anyone, since each method has its advantages and disadvantages and each of them may be subjected to further scientific discussions. Also, several power losses allocation methods have been proposed [1], [2], [3]. In the current paper the authors are focusing on Kirschen's method [4] – [7]. The authors propose a power losses allocation methodology and in the following they are presenting the influence of the commons structure modification on the active power losses allocation.

II. KIRSCHEN'S METHOD PRESENTATION

Kirschen method organises the network's buses and branches in homogeneous groups according to the following concepts: the domain of generator, commons and links.

The domain of a generator represents a set of buses, which are supplied by the power of that certain generator. The power produced by a generator supplies a particular bus, if there is a path through the network from the generator to that bus and if the direction of power flow is from the generator to the bus. Note that the domain of the generator from the point of view of the active power is not the same as that from the point of view of the reactive power.

The commons of a generator are defined as a set of neighbouring buses supplied by the same generators. The sets of buses that are unconnected with one another, but are supplied by the same generators are treated as separate commons. A bus belongs to only one common. The rank of a common is defined as the number of generators supplying power to the buses included in this common.

A link is made of one or more external branches connecting the same commons. It is very important to note that power flows from all branches of a link are all in the same direction. Furthermore, this flow from a link is always from a common of rank N to a common of rank M , where M is always greater than N .

The state of system can be represented by an acyclic graph. This graph is direct and acyclic.

Based on the previous information, the method allows the determination of contribution the generators have to the consumers within a certain domain. And also, the contribution the generators have to the individual consumers and to power flows.

The inflow of a common is defined as the sum of the power injected by sources located in a common and the one injected

in this common by external link. For each generator contribution determination, at each common, the following relations will be used:

$$F_{ijk} = C_{ij} * F_{jk} \quad (1)$$

$$I_k = \sum_j F_{jk} \quad (2)$$

$$C_{ik} = \frac{\sum_j F_{ijk}}{I_k} \quad (3)$$

where: C_{ij} – the contribution of the i generator to the load and the outflow of the j common; C_{ik} – the contribution of the i generator to the load and the outflow of the k common; F_{jk} – the flow on the link between the j and k commons; F_{ijk} – the flow on the link between the j and k commons due to the i generator; I_k – the inflow of the k common.

If the common where a bus belongs is known then the contributions of each generator at each common and the power quantity that every generator contributes to the supplying of each consumer can be established. Also it can be established the ratio of use for every branch.

III. ACTIVE POWER LOSSES ALLOCATION PROBLEM

The method proposes an evaluation algorithm of transport losses equivalent value. Let us consider a simple 3 buses power system, a source P_1 , a consumer P_2 and a passive bus (number 3). This last one is situated at equal distances from the other buses. There are two equivalent representations for active power losses: the first one (Fig. 1) having the whole ΔP value in bus number 3 or $\Delta P/2$ in the extremities buses 1 and 2 (Fig. 2).

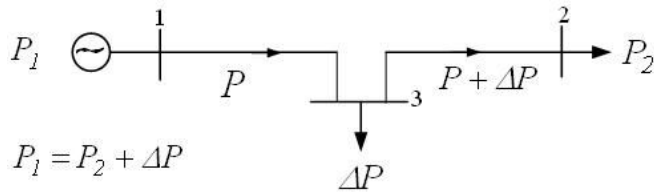

Fig. 1 Losses allocation evaluation
Representation at the middle of the branch

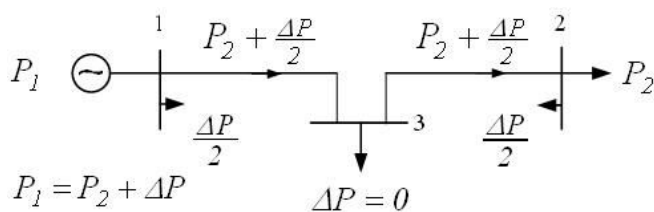

Fig. 2 Losses allocation evaluation
Representation at the extremities of the branch

IV. DESCRIPTION OF TEST POWER SYSTEM ANALYSED

The test system used for analyses has 25 buses and 29 branches. It was created on the south-west side of the National Power System. 6 P-U buses, (the slack bus is bus number 1) and 19 P-Q

buses; the voltage level for 2 buses is 400 kV, 8 buses are at 220 kV, 10 buses at 110 kV, one bus at 24 kV, 2 buses at 15 kV and 2 buses at 10 kV. In this particular state of function, 4 consumer buses and 3 P-U buses have zero consume power (these 4 P-Q buses become passive buses), and the source from bus number 6 works as a synchronous compensator (Fig. 3).

From the 29 branches, 17 are electrical overhead lines (one of 400 kV, 8 of 220 kV and 8 of 110 kV), one is under-ground line, 5 transformers and 6 autotransformers [8].

The generated and consumed active powers, for the 25 buses test system are synthesized in Table I. In Table II are presented the active power flows on the branches of Test 25 buses test power system.

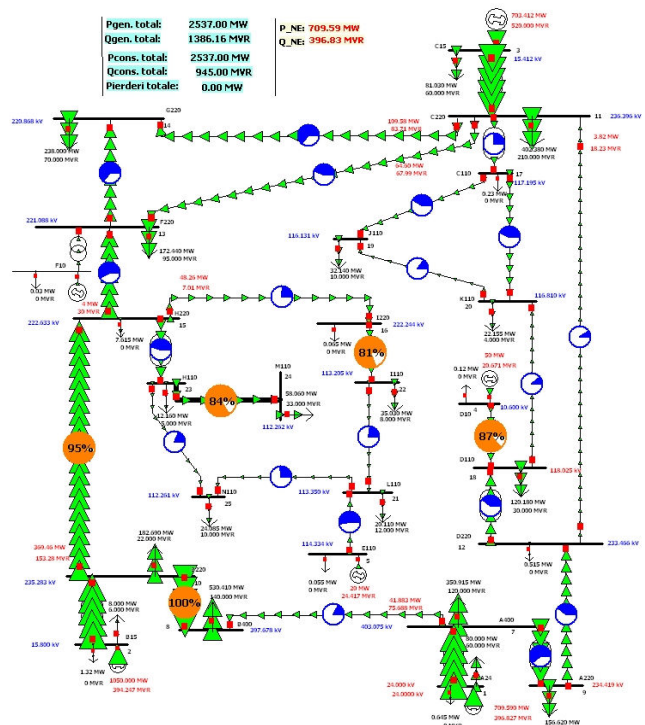

Fig. 3 Configuration of Test 25 buses test power system

TABLE I
CONFIGURATION OF THE P-U AND P-Q BUSES

Nr	Load MW	Gen MW	Nr	Load MW	Gen MW
1	80.65	709.59	14	238	0
2	9.32	1050	15	7.62	0
3	81.03	703.41	16	0.07	0
4	0.12	50	17	0.23	0
5	0.05	20	18	120.18	0
6	0.03	4	19	32.14	0
7	350.92	0	20	22.16	0
8	530.41	0	21	20.11	0
9	156.62	0	22	35.03	0
10	182.69	0	23	12.16	0
11	402.38	0	24	58.06	0
12	0.52	0	25	24.09	0
13	172.44	0			

TABLE II
 ACTIVE POWER FLOWS ON THE SYSTEM BRANCHES

From bus	To bus	From MW	From bus	To bus	From MW
1	7	628.9	6	13	4
7	9	236.1	11	14	109.6
2	10	1040.7	13	14	128.4
10	8	488.5	23	25	11.1
7	8	41.9	23	24	58.1
17	19	24	10	15	369.5
17	20	25.4	15	23	81.3
3	11	622.4	15	16	48.3
12	11	3.8	22	21	13.2
11	17	49.6	16	22	48.2
4	18	49.9	20	19	8.1
9	12	79.5	18	20	4.9
12	18	75.2	5	21	19.9
11	13	64.6	21	25	13
15	13	232.3			

V. NUMERICAL SIMULATIONS

For the test system presented in Fig. 3, four application cases of the Kirschen's method are analysed. The differences between them are made by choosing different buses to realise the commons analysed. By using these commons, the contribution of each generator in the active power can be computed. The first case is presented in detail, and for the rest, only the generators participation costs in the active power flow will be presented.

In order to calculate the transfer cost by the MW-km method, the following formula will be used:

$$TC_t = \frac{\sum_{k \in t} CL_k P_k}{P_{G_t}} [\$/MW] \quad (6)$$

where: TC_t represents the specific flow cost for the t transaction; c – the specific cost in $\$/MWkm$; L_k – the length of the k line in km; P_k – the transfer power on the k line; P_{G_t} – the power produced by the source of the t transaction. As for the specific cost, the authors used a value for $c = 2\$/MWkm$.

A. Case 1

According to the structure of the analysed test system and to the principles stated above, the commons will be defined as presented in Table III.

TABLE III
 DEFINITIONS OF ANALYSED SYSTEM COMMONS

Nr.	Component bus	Input power [MW]	Output power [MW]
1	1, 7, 9	709.59	588.71
2	2, 8, 10	1050	800.33
3	3, 11, 17, 19, 20	703.41	721.64
4	4, 18, 12	50	174.6
5	5, 15, 16, 21, 22, 23, 24,	20	79.28
5	25		
6	6, 14, 13	4	172.47

Table IV contains the definitions of the links between zones.

TABLE IV
 DEFINITIONS OF ANALYSED SYSTEM LINKS

From	To	Branch	Value [MW]
1	2	7_8	41.9
2	5	23_25, 16_22	59.3
2	6	15_13	232.3
1	4	12_18	75.2
3	4	17_19, 17_20	49.4
6	3	13_14	128.4
1	3	12_11	3.8
3	6	11_13	64.6

Fig. 4 presents the state graph, which expresses the link between the commons of the analysed system.

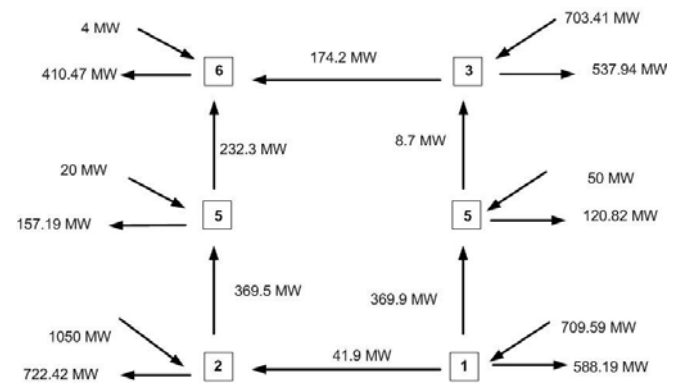

Fig. 4 State acyclic graph for case 1

B. Case 2

According to the structure of the analysed test system and to the principles stated above, the commons will be defined as presented in Table V.

TABLE V
 DEFINITIONS OF ANALYSED SYSTEM COMMONS

Nr.	Component bus	Input power [MW]	Output power [MW]
1	1, 7, 9, 12	709.59	588.19
2	2, 8, 10, 15	1050	730.04
3	3, 11, 17, 19	703.41	515.78
4	4, 18, 20	50	142.46
5	5, 16, 21, 22, 23, 24, 25	20	149.57
6	6, 14, 13	4	410.47

Table VI contains the definitions of the links between zones.

TABLE VI
 DEFINITIONS OF ANALYSED SYSTEM LINKS

From	To	Branch	Value [MW]
1	2	7_8	41.9
2	5	15_23, 15_16	129.6
2	6	15_13	232.3
1	4	12_18	75.2
4	3	20_19	8.1
3	6	11_13, 11_14	174.2
1	3	12_11	3.8
3	4	17_20	25.4

Fig. 5 presents the state graph, which expresses the link between the commons of the analysed system.

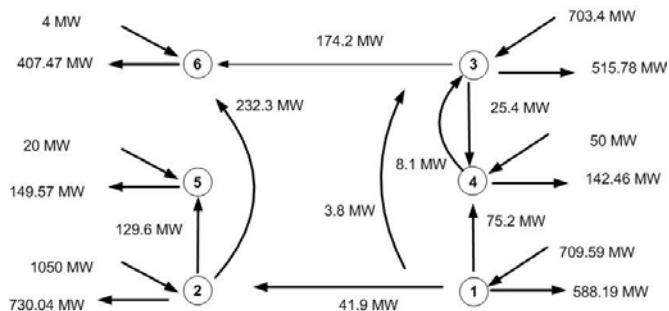

Fig. 5 State acyclic graph for case 2

C. Case 3

According to the structure of the analysed test system and to the principles stated above, the commons will be defined as presented in Table VII.

TABLE VII
DEFINITIONS OF ANALYSED SYSTEM COMMONS

Nr.	Component bus	Input power [MW]	Output power [MW]
1	1, 7, 9, 12	709.59	588.71
2	2, 8, 10, 15, 16, 23, 24	1050	800.33
3	3, 11, 17, 14	703.41	721.64
4	4, 18, 20, 19	50	174.6
5	5, 21, 22, 25	20	79.28
6	6, 13	4	172.47

Table VIII contains the definitions of the links between zones.

TABLE VIII
DEFINITIONS OF ANALYSED SYSTEM LINKS

From	To	Branch	Value [MW]
1	2	7_8	41.9
2	5	23_25, 16_22	59.3
2	6	15_13	232.3
1	4	12_18	75.2
3	4	17_19, 17_20	49.4
6	3	13_14	128.4
1	3	12_11	3.8
3	6	11_13	64.6

Fig. 6 presents the state graph, which expresses the link between the commons of the analysed system.

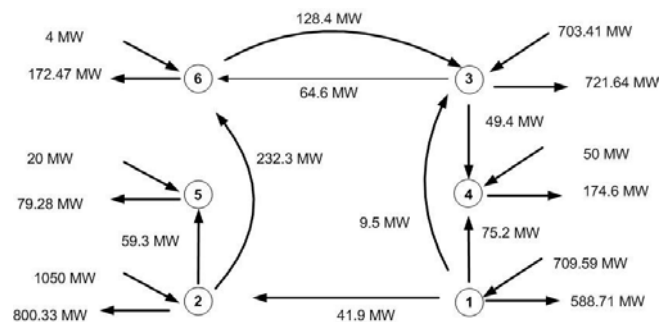

Fig. 6 State acyclic graph for case 3

D. Case 4

According to the structure of the analysed test system and to the principles stated above, the commons will be defined as presented in Table IX.

TABLE IX
DEFINITIONS OF ANALYSED SYSTEM COMMONS

Nr.	Component bus	Input power [MW]	Output power [MW]
1	1, 7, 9	709.59	588.19
2	2, 8, 10, 15, 16, 22, 23, 24	1050	835.36
3	3, 11, 17, 13, 14	703.41	894.08
4	4, 12, 18, 20, 19	50	175.12
5	5, 21, 25	20	44.25
6	6	4	0.03

Table X contains the definitions of the links between zones.

TABLE X
DEFINITIONS OF ANALYSED SYSTEM LINKS

From	To	Branch	Value [MW]
1	2	7_8	41.9
4	3	11_12	3.8
3	4	17_19, 17_20	49.4
1	4	9_12	79.5
2	5	22_21, 23_25	24.3
6	3	6_13	3.97
2	3	15_13	232.3
1	2	7_8	41.9

Fig. 7 presents the state graph, which expresses the link between the commons of the analysed system.

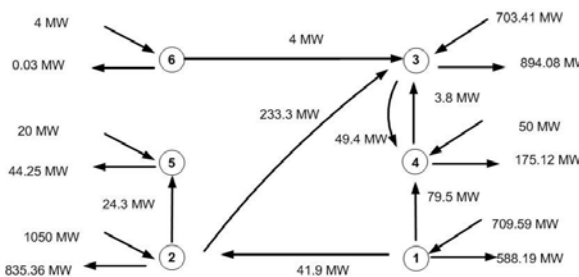

Fig. 7 State acyclic graph for case 4

Several graphic representations were plotted based on the results obtained from the previous 4 cases. The authors observed a relatively high sensitivity of costs components in correlation to the obtained cases. There are important differences between the total transfer specific costs for the G_1 , G_2 and G_3 generators, due to the high values of the active generated powers (Fig 10). The highly values are recorded for the generator G_1 case, case 3 is worth to be pointed (3100.31 \$/MW). For the G_4 , G_5 , G_6 generators cases, the obtained values in all the situations are very close.

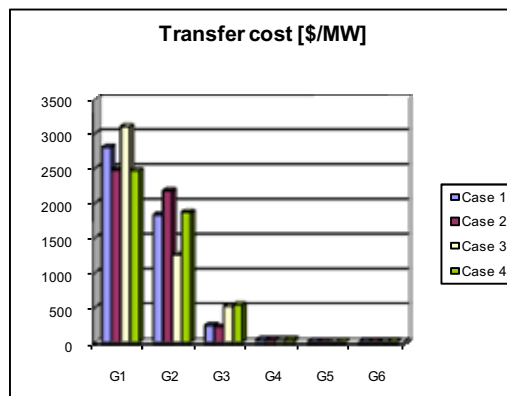

Fig. 8 Specific transfer costs

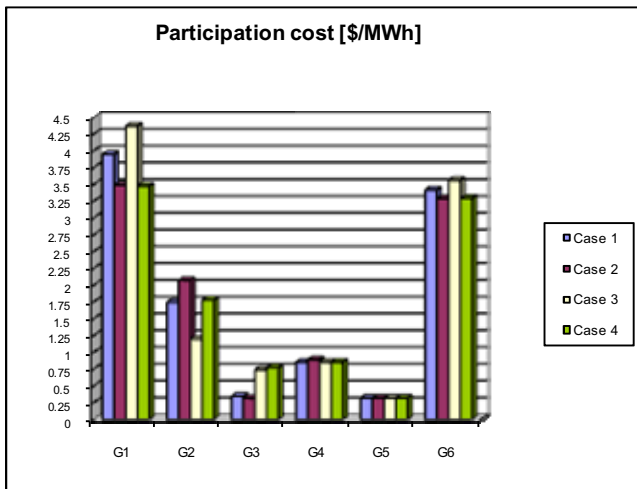

Fig. 9 Transfer participation cost

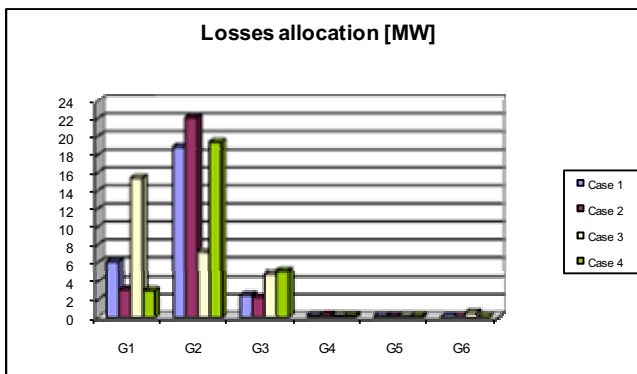

Fig. 10 Active power losses allocation

The previous observations are not suitable any more, for the participation costs case (Fig. 11). Although the case 3 of generating unit G_1 worth to be pointed, taking into consideration the highly cost of 4.36 \$/MW, it is also interesting the influence of synchronous compensator on the cost (G_6). Its value is very close to the G_1 's value: 3.56 \$/MWh.

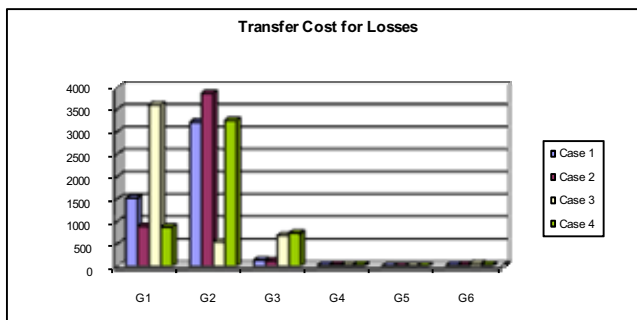

Fig. 11 Specific transfer costs of the losses

The G_2 generator, having the generating capacity of 1050 MW, will allocate the highest value for losses, 22.14 MW (case 2), followed by G_1 , with only 15.43 MW (case 3). G_4 , G_5 , G_6 generators will allocate much lower quantities and represents

insignificant differences in all the cases (Fig. 12).

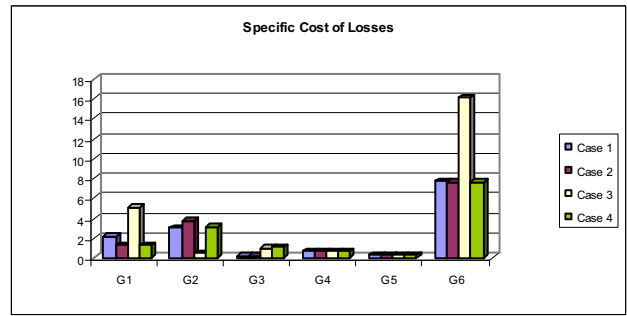

Fig. 12 Participation costs of the losses

Regarding the total specific costs problem, the obtained values in case of the losses, are higher than the values obtained in case of the transfer: 3856.5 \$/MW against 3100.31 \$/MW (Fig. 13).

It must be pointed that in this situation too, the same value of the specific cost was used. Taking into consideration the participation cost for the losses case, the synchronous compensator presents a value of 16.11 \$/MWh, 5 times higher than the participation cost in case of the transfer on the branches.

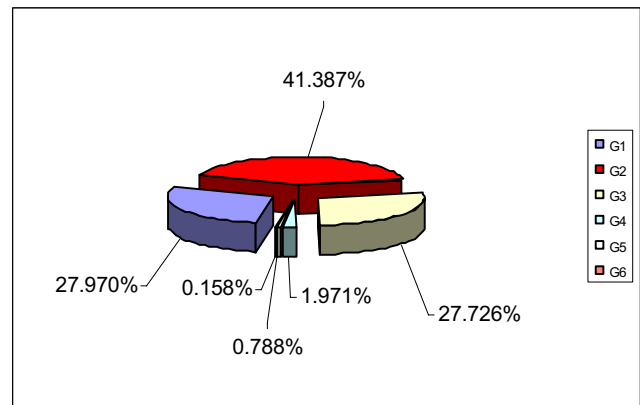

Fig. 13 Total generating capacity

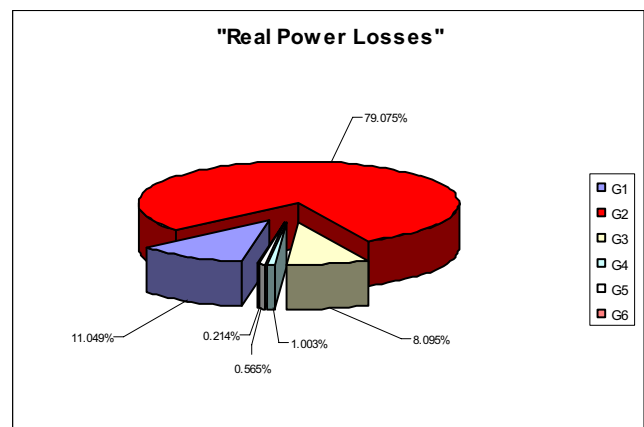

Fig. 14 The losses allocation percent on each generator

VI. CONCLUSION

The power system configuration has an important influence on the active power losses allocation. This fact is proved by the

global situation of the active generated power (Fig. 13). G_2 has the highest participation value (41.38%), followed by G_1 (only 27.97%). The smallest value is recorded for the synchronous compensator (0.15%), playing another important role within the power system. Obviously, the observation is valuable in the active power losses allocation case too, presented in Fig. 14. The G_2 generator allocates 79.07 % and G_1 allocates 11.04 %.

The G_2 generator, which produces power at low price, has no constraints regarding power ejection. If congestion would occur, the transfer cost will increase, regardless of the method used to choose the areas.

REFERENCES

- [1] Bialek J. W., Ziemianek S., Wallace R., „A Methodology for Allocating Transmission Losses due to Cross-border Trades”, IEEE Transactions on Power System, Vol. 19, No. 3, August 2004, pp. 1255-1262.
- [2] A. J. Conejo, J. M. Arroyo, N. Alguacil, A. L. Guijarro, “Transmission Loss Allocation: A Comparison of Different Practical Algorithms”, IEEE Transactions On Power Systems, Vol. 17, No. 3, August 2002, pp. 571-576.
- [3] Bialek J., „Allocation of Transmission Supplementary Charge to Real and Reactive Loads”, IEEE Transactions on Power System, Vol. 13, No. 3, August 1998, pp. 749-754.
- [4] Bialek J., „Topological Generation and Load Distribution Factors for Supplement Charge Allocation in Transmission Open Access”, IEEE Transactions on Power System, Vol. 12, No. 3, August 1997, pp. 1185-1193.
- [5] Shahidepour M., Yahim H., Li Z., „Market Operations in Electric Power Systems. Forecasting, Scheduling and Risk Management”, A John Wiley&Sons, INC, 2002.
- [6] Strbac G., Kirschen D., Almed S., „Allocating Transmission System Usage on the Basis of Traceable Contributions of Generators and Loads to Flow”, IEEE Transactions on Power System, Vol. 13, No. 2, May 1998, pp. 527-534.
- [7] Kirschen D., Strbac G., „Tracing Active and Reactive Power between Generators and Load Using Real and Imaginary Currents”, IEEE Transactions on Power System, Vol. 14, No. 4, November 1999, pp. 1212-1319.
- [8] Kischen D., Allan R., Strbac G., „Contributions of Individual Generators to Loads and Flow”, IEEE Transactions on Power System, Vol. 12, No. 1, February 1997, pp. 52-66.
- [9] Barbulescu C., Vuc Gh., Kilyeni St., “Probabilistic Load Modelling Influences on the Load Flow. Case Study TEST25 Test Power System”, Proceedings of the International Youth Conference on Energetics (IYCE) 2007, 31.V-02.VI.2007, Budapest, Hungary, ISBN: 978-963-420-908-9, pag. 175.
- [10] Oana Pop, Mircea Nemes, „Power System Allocation with Network Matrices”, Proceeding of the 7th International Power Systems Conference, November 22-23, 2007, pp. 527-534.