

Matrix-Based Linear Analysis of Switched Reluctance Generator with Optimum Pole Angles Determination

Walid A. M. Ghoneim, Hamdy A. Ashour, Asmaa E. Abdo

Abstract—In this paper, linear analysis of a Switched Reluctance Generator (SRG) model is applied on the most common configurations (4/2, 6/4 and 8/6) for both conventional short-pitched and fully-pitched designs, in order to determine the optimum stator/rotor pole angles at which the maximum output voltage is generated per unit excitation current. This study is focused on SRG analysis and design as a proposed solution for renewable energy applications, such as wind energy conversion systems. The world's potential to develop the renewable energy technologies through dedicated scientific researches was the motive behind this study due to its positive impact on economy and environment. In addition, the problem of rare earth metals (Permanent magnet) caused by mining limitations, banned export by top producers and environment restrictions leads to the unavailability of materials used for rotating machines manufacturing. This challenge gave authors the opportunity to study, analyze and determine the optimum design of the SRG that has the benefit to be free from permanent magnets, rotor windings, with flexible control system and compatible with any application that requires variable-speed operation. In addition, SRG has been proved to be very efficient and reliable in both low-speed or high-speed applications. Linear analysis was performed using MATLAB simulations based on the (Modified generalized matrix approach) of Switched Reluctance Machine (SRM). About 90 different pole angles combinations and excitation patterns were simulated through this study, and the optimum output results for each case were recorded and presented in detail. This procedure has been proved to be applicable for any SRG configuration, dimension and excitation pattern. The delivered results of this study provide evidence for using the 4-phase 8/6 fully pitched SRG as the main optimum configuration for the same machine dimensions at the same angular speed.

Keywords—Generalized matrix approach, linear analysis, renewable applications, switched reluctance generator, SRG.

I. INTRODUCTION

THIS document is a concentrated study of SRG based on the Generalized Matrix Approach theory. SRG has been found to offer intrinsic advantages over conventional AC machines in generating operations, and has proved to be the potential candidate for abundant of industrial and renewable applications. The switched reluctance machine as a motor has been known for more than 150 years; however, the generation mode of SRG has recently attracted considerable interest due to its special excitation requirements that limited earlier

investigations, researches and applications. Thanks to the development of power electronic components and the advent of affordable digital controllers, the research interest in SRG has increased [1]. On the other hand, one of the most common AC generators – the Permanent Magnet Synchronous Generator (PMSG) – has significant disadvantages such as the structure material is sensitive to temperature; thus, additional temperature monitoring and cooling systems are required, the PMSG control system may have limited flexibility, low robustness, cogging torque and high maintenance requirements. This offers an incentive to find an efficient alternative to PMSG for variable speed applications, particularly for wind energy conversion systems. Throughout this paper, a review of SRG advantages, applications, drive system, and different winding configurations were mentioned. Also, the generalized matrix theory of SRM has been utilized to analyze (4/2, 6/4, and 8/6) SRGs with various stator coil pitches. Analysis of both short-pitched and fully-pitched SRG configurations has been discussed and results comparisons have been highlighted. Finally, the conclusion has been delivered with the recommended optimum machine preliminary design for any further non-linear finite element analysis, then implementation.

A. SRG Advantages

SRG is commonly quoted for several advantages over conventional generators; Induction Generator and PMSG, such as: the absence of permanent magnets, reliability, robustness, low manufacturing costs, higher efficiency and wider operational speed range. In addition, current, voltage and torque ripples that can be controlled by power electronics are used for SRG driving [2]. The absence of windings and permanent magnets on the rotor supports both high rotational speed and high-temperature operation. Furthermore, the absence of windings on the rotor (passive rotor) reduces the overall copper losses within the stator, making the SRG relatively easy to cool. The switching nature of the SRG makes it compatible with any application that requires variable-speed operation. In wind energy applications, variable speed operation is needed to extract additional energy from the wind stream and to decrease the mechanical stresses within the system [3]. The power-to-weight and torque-to-weight ratios are higher than the

W. A. M. Ghoneim, H. A. Ashour and A. E. Abdo are with the Electrical Engineering and Automatic Control Department, Arab Academy for Science, Technology and Maritime Transport, Alexandria, Egypt (e-mail: walidghoneim1970@gmail.com, hashour@aast.edu, asmaa.el-sayed@siemens.com).

conventional synchronous generators. Since phases of SRG are independent, the generator has the advantage to be tolerant to windings open-coil and power electronics faults. In addition, the layout of SRG is so flexible that it can be designed flat as a disk or the rotor can be placed outside the stator. This flexibility combined with the simplified overall construction opens up an entirely new field of mechatronics. SRG efficiency depends on the silicon steel or alloys material quality that is utilized for stator and rotor construction [4].

B. SRG Applications

SRG is very efficient and reliable in both low-speed and high-speed applications:

- In low-speed applications: such as wind turbines and hydro turbines.
- In high-speed applications: such as gas turbines, steam turbines, expansion turbines (turbo-expanders) for industrial oil and gas processes, micro combined heat and power (micro-CHP) systems for domestic appliances, etc., due to the higher efficiency values in high-power/high-speed applications as it could reach about 98% depending on the speed and power values [4].

II. SRG DRIVE SYSTEM

A typical drive system for a SRG is shown in Fig. 1. This drive system structure consists of converter and closed loop control system, as the SRG is unstable for operation in open loop. The converter drives the SRG representing only one phase; thus, it must be duplicated for the rest of phases. It is either an asymmetrical or a symmetrical one based on the polarity of the excitation current per phase: unipolar or bipolar. SRG can provide DC power directly to the load as shown or send the generated energy to the grid using an additional DC/AC power converter [5].

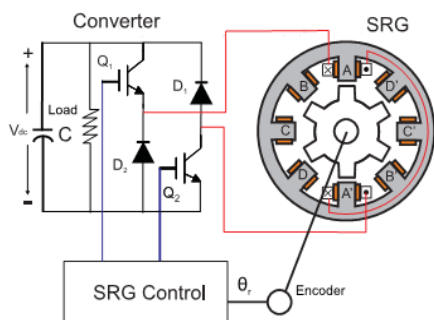

Fig. 1 Drive system of SRG [5]

III. SRG OPERATING PRINCIPLE AND BASIC EQUATIONS

The movement of the rotor with respect to the excited stator phase varies the inductance of the generator periodically from maximum to minimum; hence, voltage and power is produced. During the aligned position of the rotor and stator, inductance is maximum and minimum during the non-aligned position. For SRG, the excitation of the stator phase must be made when the rotor is moving past the stator when inductance is decreasing as shown in Figs. 2 (a) and (b) [6].

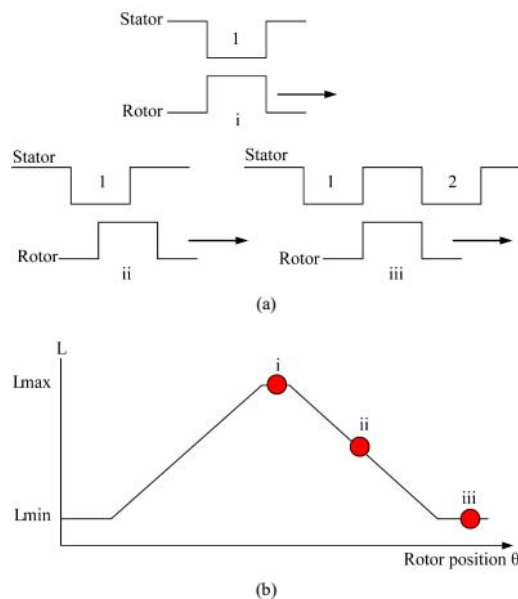

Fig. 2 Variation of inductance with respect to the movement of rotor: (a) Rotor movement with respect to stator; i) Maximum inductance, minimum reluctance (full alignment); ii) Inductance decreasing linearly; iii) Minimum inductance (misalignment); (b) Complete inductance profile with respect to rotor position [6]

The electromagnetic torque (T_e) is produced by the tendency of the rotor moving to the excited stator phase winding where minimum reluctance occurs independent of the direction of current flow (i) as shown by (1):

$$T = \frac{\partial W}{\partial \theta} = \frac{1}{2} i^2 \frac{\partial L}{\partial \theta} \begin{cases} \frac{\partial L}{\partial \theta} < 0 \rightarrow T < 0 \text{ Generator mode} \\ \frac{\partial L}{\partial \theta} > 0 \rightarrow T > 0 \text{ Motor mode} \end{cases} \quad (1)$$

where, L is the phase inductance, W shows the mechanical work done by machine and θ is the rotor angular position [3]. The real value of inductance in general can be obtained by (2):

$$L = \frac{N^2}{Re} = \frac{\mu \cdot A \cdot N^2}{l} \quad (2)$$

where, A is the mean area of the cross section of flux path, l is the length of this path in each different part, Re is the magnetic reluctance, μ is magnetic permeability and N is number of turns per pole. The magnetic reluctance value of SRG is variable for each angle because of the corresponding change in flux path. Thus, core reluctance is calculated according to its non-linear behavior, as per (3):

$$R = \frac{l}{\mu \cdot A} = \frac{l}{\left(\frac{B}{H}\right) \cdot A} = \frac{H \cdot l}{B \cdot A} = \frac{H \cdot l}{\phi} \quad (3)$$

where, B is the magnetic flux density, H is magnetic field intensity and ϕ is magnetic flux.

With $\lambda(\theta, i) = L(\theta, i) \cdot i$ [7]; the voltage equation of SRG for one phase winding takes into account the following assumptions; mutual coupling between phases is almost zero, no fringing effect of flux around pole corners and all flux

between poles crosses the air gap in the radial direction is as [5]:

$$V = Ri + \frac{\partial \lambda(\theta, i)}{\partial t} \quad (4)$$

where i is generator phase current and λ is the flux linkage which is the function of both phase current and rotor position; therefore, (4) can be rewritten as:

$$V = Ri + \frac{\partial \lambda}{\partial i} \frac{di}{dt} + \frac{\partial \lambda}{\partial \theta} \frac{d\theta}{dt} \quad (5)$$

For a given current, L is a function of rotor position and is a linear quantity. Since $\omega = d\theta/dt$, hence (5) can be rewritten as:

$$V = Ri + L(\theta) \frac{di}{dt} + i\omega \frac{dL(\theta)}{d\theta} \quad (6)$$

where V is the DC terminal voltage, i is the phase current, λ is the flux linkage (Volt. Sec), R is the phase resistance, L phase inductance, θ indicates the rotor position and ω is the angular velocity of the rotor (rad/s). The last parameter on the right-hand side is the back Electromotive Force (EMF) of the machine and it appears during separation of poles and with increase in speed. Analysis of the back EMF gives an important insight into SRG operation. First, back EMF is a function of phase current, machine speed and phase inductance. Second, the back EMF polarity depends on the inductance variation [8]. The general mathematical model of the n-phase SRG voltage equation is:

$$\begin{bmatrix} V_a \\ V_b \\ V_c \\ \vdots \\ V_p \end{bmatrix} = \begin{bmatrix} R_a & 0 & 0 & \dots & 0 \\ 0 & R_b & 0 & \dots & 0 \\ 0 & 0 & R_c & \dots & 0 \\ \vdots & \vdots & \vdots & \ddots & \vdots \\ 0 & 0 & 0 & \dots & R_p \end{bmatrix} \begin{bmatrix} i_a \\ i_b \\ i_c \\ \vdots \\ i_p \end{bmatrix} + \begin{bmatrix} L_{aa} & M_{ab} & M_{ac} & \dots & M_{ap} \\ M_{ba} & L_{bb} & M_{bc} & \dots & M_{bp} \\ M_{ca} & M_{cb} & L_{cc} & \dots & M_{cp} \\ \vdots & \vdots & \vdots & \ddots & \vdots \\ M_{np} & \dots & \dots & \dots & L_{pp} \end{bmatrix} \begin{bmatrix} di_a/dt \\ di_b/dt \\ di_c/dt \\ \vdots \\ di_p/dt \end{bmatrix} + \omega \begin{bmatrix} dL_{aa}/d\theta & dM_{ab}/d\theta & dM_{ac}/d\theta & \dots & dM_{ap}/d\theta \\ dM_{ba}/d\theta & dL_{bb}/d\theta & dM_{bc}/d\theta & \dots & dM_{bp}/d\theta \\ dM_{ca}/d\theta & dM_{cb}/d\theta & dL_{cc}/d\theta & \dots & dM_{cp}/d\theta \\ \vdots & \vdots & \vdots & \ddots & \vdots \\ dM_{np}/d\theta & dM_{np}/d\theta & dM_{np}/d\theta & \dots & dL_{pp}/d\theta \end{bmatrix} \begin{bmatrix} i_a \\ i_b \\ i_c \\ \vdots \\ i_p \end{bmatrix} \quad (7)$$

where n is the number of phases; i_a is the current of phase a; L_{aa} is the self-inductance of phase a; M_{ab} is mutual inductances among phase b; θ is the rotor angular position. From the back EMF equation, it can be seen that $(dL/d\theta)$ represents the slope of the inductance profile as shown in Fig. 2 (b) [6].

IV. SRG EXCITATION CIRCUIT AND WINDING CONFIGURATIONS

SRG operates in two stages: excitation and generation. The

excitation stage is performed when one phase of the SRG is submitted to the excitation voltage, which causes current flow in the winding of this phase. In generating stage, the current flows through the SRG phase to the load. The most common converter circuit for SRG is the Asymmetric Half Bridge Converter (AHBC) [5]. SRG excitation current per phase can be either unipolar or bipolar.

Conventional SRG has been developed around the concept of short pitching each phase winding, generally around a single stator-pole. Fig. 3 shows a conventional SRG. The utilization of the electric circuit is poor since each phase winding can only contribute to effective voltage for a maximum of half the electrical cycle [9].

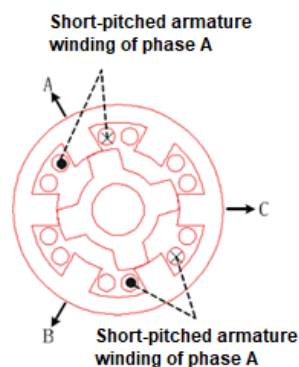

Fig. 3 Short-pitched doubly salient configuration [9]

If stator windings are wound with fully-pitched pattern in SRG, as shown in Fig. 4, then this configuration allows for producing more output voltage due to the mutual inductance variation between phases. The total flux produced by any phase is double of which was produced in the conventional short-pitched machine. This is due to better magnetic circuit utilization as more winding turns can be added for the same stator dimensions. For each phase contributing to effective voltage production at least two thirds of the cycle of rotation; as a result, subsequent increase in voltage and output power per unit volume can be achieved [9].

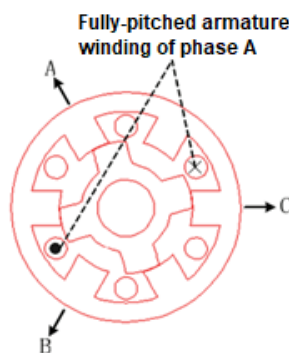

Fig. 4 Fully-pitched doubly salient configuration [9]

V. SRG LINEAR ANALYSIS BASED ON THE GENERALIZED MATRIX APPROACH

SRGs have been analyzed in terms of current excitation pattern, flux distribution and voltage production. The remaining

machine dimensions can then be calculated based on the dimensions obtained by this analysis. The modified generalized, unified matrix solution provides a reliable method that can be used for calculating the flux, current and output EMF per phase of any doubly salient SRG by the general steps that have a detailed description in [10] and [11]. In this study, the generalized linear analysis theory was applied to analyze 2-phase, 3-phase and 4-phase SRG with various stator coil pitches.

rotor pole arcs (β_s, β_r), which is an objective of this study. Figs. 11, 14, 15, 21, 24 and 26 show how EMF varies with β_s and β_r . In each case an optimal β_s, β_r exists for a given N_s, N_r .

Open Science Index, Electrical and Computer Engineering Vol:15, No:4, 2021 publications.waset.org/10011967.pdf

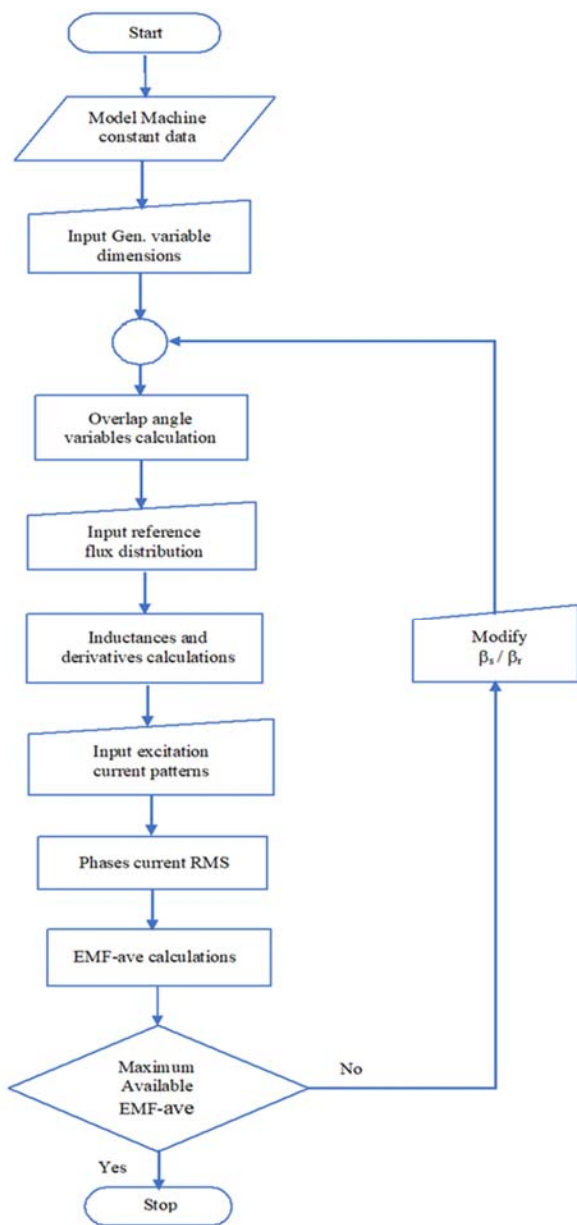

Fig. 5 SRG Linear analysis workflow

The outlined procedure was utilized to calculate the output EMF for a particular β_s and β_r that is, EMF ($\beta_s, \beta_r, \theta, i$). For given machine dimensions, see Table I, winding configuration, angular speed and excitation current pattern (and magnitude), the EMF developed can be calculated for various stator and

TABLE I
DIMENSIONS OF THE TESTED SRG MODEL

Name	Value
Core length	125 mm
Stator Yoke thickness	12 mm
Stator Core diameter on gap side	75.4 mm
Stator Core diameter on yoke side	148 mm
Rotor Yoke thickness	9 mm
Rotor Core diameter on gap side	74.7 mm
Rotor Core diameter on yoke side	37.35 mm
Stator Pole Embrace	Stator Pole arc / Pole pitch
Rotor Pole Embrace	Rotor Pole arc / Pole pitch

The graphical EMF determination method proceeds as follows:

- 1) Plot $dL_i/d\theta$ and $dM_{ij}/d\theta$ for one complete machine electrical cycle ($2\pi/N_r$).
- 2) Assign phase excitation currents (i_i) (1, -1 or 0).
- 3) Multiply the appropriate currents and inductance differentials.
- 4) Add in time (within each step angle) the individual EMF component associated with each self and mutual inductance component [10].

Based on the previous literature, SRG analysis in this study has been carried out at a fixed prime-mover speed of 100 RPM; Fig. 5 illustrates the analysis work flow.

SRG analysis of this study has been carried out for (2-phase 4/2, 3-phase 6/4 and 4-phase 8/6) of the main winding configurations: the conventional short-pitched and fully-pitched designs.

A. Short-Pitched Results

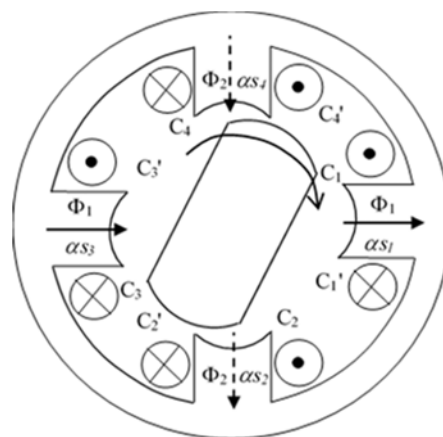

Fig. 6 Short-pitched 4/2 SRG ($\rho = 1$) [10]

1) Two-Phase 4/2 SRG

The 4/2 SRG consists of four stator poles and two rotor poles; applying the graphical EMF determination method described previously on 54 different SRGs with stator and rotor teeth angles ($\beta_s^\circ, \beta_r^\circ$) and range from ($15^\circ, 30^\circ$) to ($90^\circ, 150^\circ$) is performed. From the linear analysis results, the maximum

generated EMF of -1.77 V per phase per unit-current occurs at optimum stator and rotor pole arcs of 90° each.

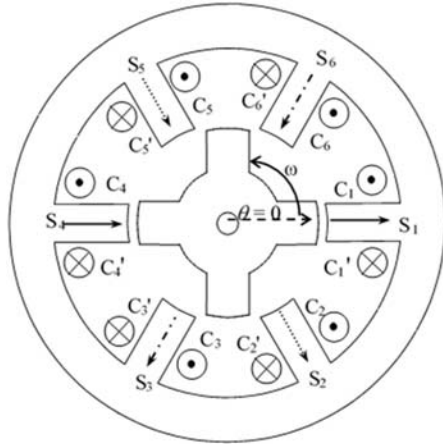

Fig. 7 Short-pitched 6/4 SRG ($p = 1$) [10]

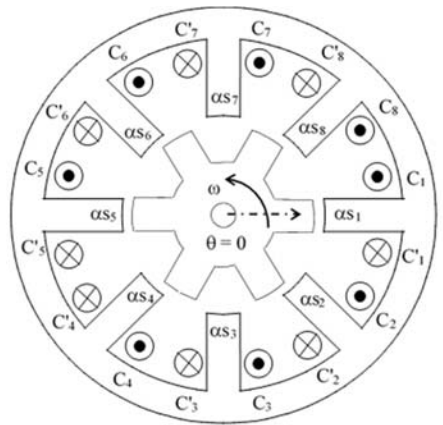

Fig. 8 Short-pitched 8/6 SRG ($p = 1$) [10]

Matrix I indicates the injected unipolar excitation current, as the elements in each row of I has a positive or zero excitation current with only one phase at a time.

$$I = \begin{bmatrix} 1 & 0 \\ 0 & 1 \end{bmatrix}$$

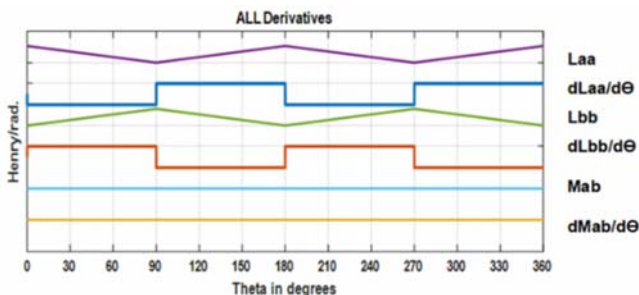

Fig. 9 Short-pitched 4/2 SRG self-inductances, its derivatives and zero- mutual inductances waveforms at stator and rotor teeth angles (90°, 90°)

The maximum output EMF per unit current E_a and E_b ,

generated by a prime-mover speed of 100 RPM are shown in Fig. 10.

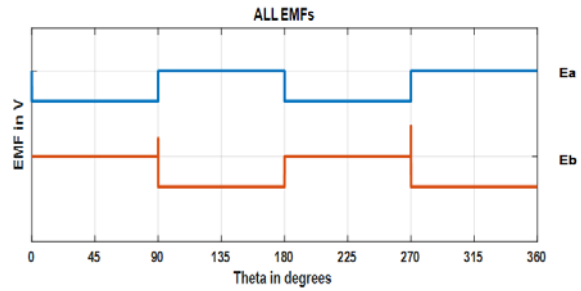

Fig. 10 Short-pitched 4/2 SRG maximum output EMF E_a and E_b waveforms at stator and rotor teeth angles (90°, 90°)

The total EMF output values per phase per unit current dependency on stator and rotor teeth angles, β_s and β_r are indicated in Fig. 11. The optimum total value of the two phases is about -3.5 volts per unit current and has been achieved at angles (90°, 90°).

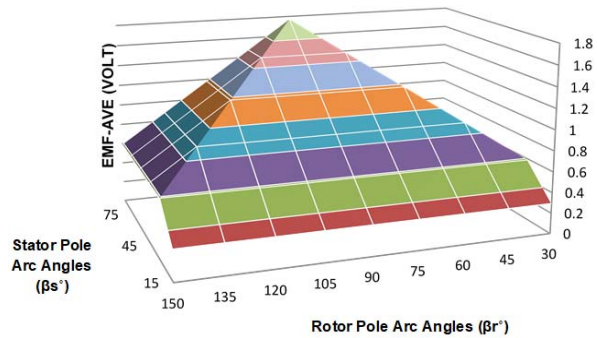

Fig. 11 The output EMF per phase per unit current versus β_s and β_r of 4/2 short-pitched SRG: with unipolar single-phase excitation

2) Three-Phase 6/4 SRG

The conventional 3-phase SRG, shown in Fig. 7, has six short-pitched coils, with diagonally opposite coils connected in a series to form phases. The flux produced by exciting phase one is shown in solid lines, the flux produced by exciting phase two is shown dashed, and phase three flux is shown as dash-dot. Since no coils overlap, voltage production is due to self-inductance variations ($dL/d\theta$); hence only unipolar excitation currents are employed. Applying MATLAB EMF simulations on 3-phase short-pitched SRG with different stator and rotor teeth angles, β_s (from 15° to $\beta_{s\max}$ 60°) and β_r (from 15° to $\beta_{r\max}$ 90°). From the simulation results, the maximum total EMF per unit current of -5.3043 V is produced at stator/rotor teeth angles (45°, 45°). Self-inductances waveforms and its derivatives are shown in Fig. 12.

The injected current matrix for unipolar 2-phase excitation to produce the maximum EMF- Ave:

$$I = \begin{bmatrix} 1 & 1 & 1 & 0 & 0 & 0 \\ 0 & 0 & 1 & 1 & 1 & 0 \\ 1 & 0 & 0 & 0 & 1 & 1 \end{bmatrix}$$

The waveforms of the generated EMF for phase a, b and c per unit current are shown in Fig. 13.

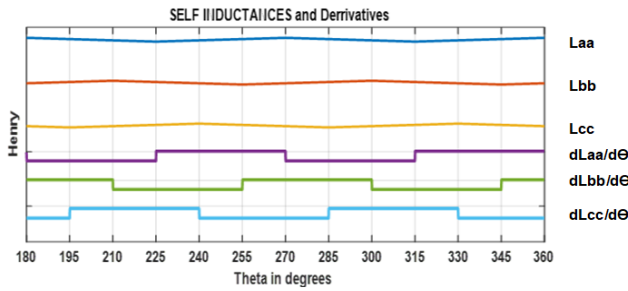

Fig. 12 Short-pitched 6/4 SRG Self-inductances and derivatives waveforms at stator and rotor teeth angles (45°, 45°)

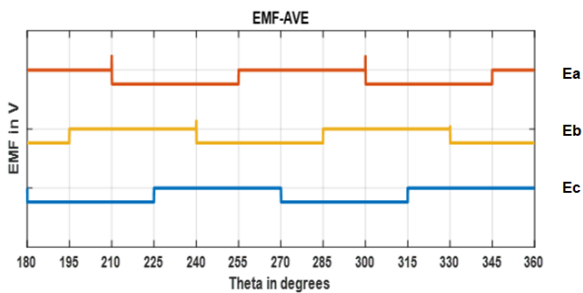

Fig. 13 Short-pitched 6/4 SRG output EMF Ea, Eb and Ec waveforms at stator and rotor teeth angles (45°, 45°)

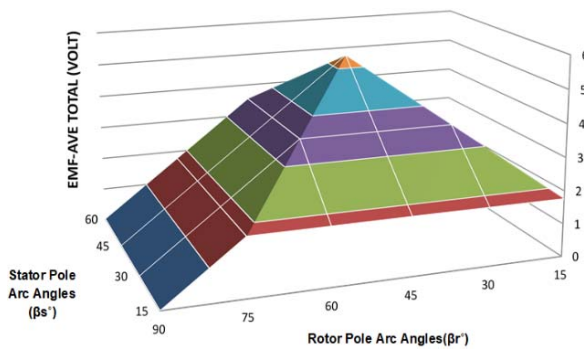

Fig. 14 The output total EMF per unit current versus β_s and β_r for 6/4 short-pitched SRG: Unipolar, 2-phase excitation

3) Four-Phase 8/6 SRG

The short-pitched 8/6 SRG is shown in Fig. 8, and has eight short-pitched coils ($\rho = 1$) with diagonally opposite coils commutatively connected to form phases. The machine can be operated in a single-phase, unipolar excitation pattern or with two unipolar phases excited simultaneously. Significantly more EMF is produced with 2-phase excitation. Depending on the figure analysis of self-inductances derivatives, it was possible to apply the 2-phase excitation current pattern on (30°, 30°) design. Hence, the maximum total EMF production of the four phase SRG at stator/rotor tooth angles of (30°, 30°) has the value of -7.0667 V/per unit current. This value is twice the maximum EMF-ave produced by single-phase excitation. The unipolar 2-phase excitation current pattern:

$$I = \begin{bmatrix} 1 & 1 & 0 & 0 \\ 0 & 1 & 1 & 0 \\ 0 & 0 & 1 & 1 \\ 1 & 0 & 0 & 1 \end{bmatrix}$$

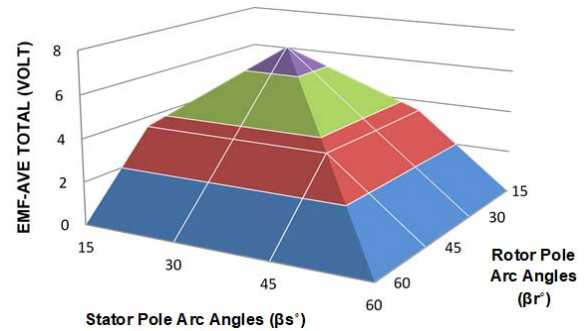

Fig. 15 The output total EMF and its dependency on stator/rotor teeth angles

TABLE II
LINEAR ANALYSIS OPTIMUM RESULTS OF SHORT-PITCHED SRG POLE ANGLES WITH ASSOCIATED MAXIMUM VOLTAGE OUTPUTS

SRG	Coil Pitch, ρ	Excitation	$\beta_s^\circ/\beta_r^\circ$	Total EMF/unit current (V)
2phase, 4/2	Short-pitched ($\rho = 1$)	Unipolar Single-phase	90°/90°	-3.54
3phase, 6/4	Short-pitched ($\rho = 1$)	Unipolar Two-phase	45°/45°	-5.30
4phase, 8/6	Short-pitched ($\rho = 1$)	Unipolar Two-phase	30°/30°	-7.07

B. Fully-Pitched Results

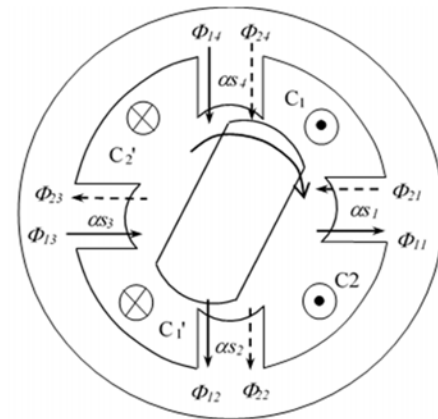

Fig. 16 Fully-pitched 4/2 SRG ($\rho = 2$) [10]

1) Two-Phase 4/2 SRG

Voltage production in fully-pitched SRG is due to mutual inductance variations ($dM/d\theta$).

Best performance of 2-phase SRG linear analysis (maximum theoretical output) was achieved with the fully-pitched SRG, when both phases are excited simultaneously with bipolar current.

The injected bipolar excitation current pattern for EMF maximum value is:

$$I = \begin{bmatrix} -1 & 1 \\ -1 & 1 \end{bmatrix}$$

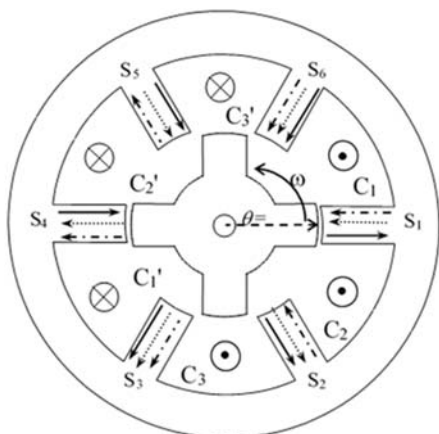

Fig. 17 Fully-pitched 6/4 SRG ($\rho = 3$) [10]

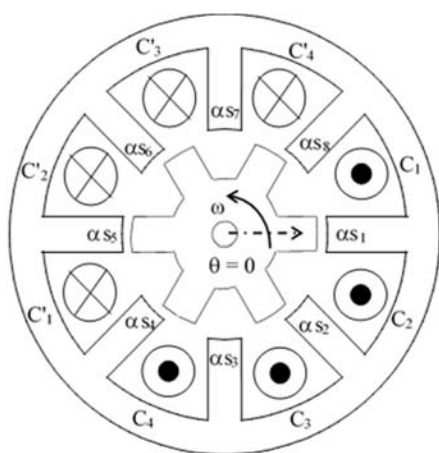

Fig. 18 Fully-pitched 8/6 SRG ($\rho = 4$) [10]

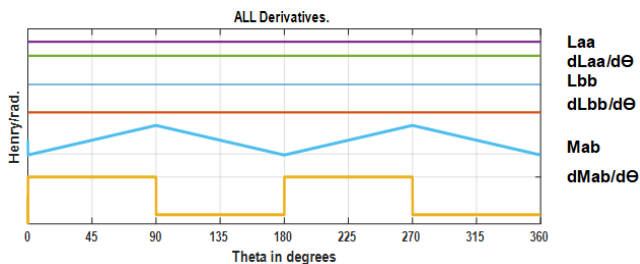

Fig. 19 Fully-pitched 4/2 SRG zero Self-inductances, mutual inductance and its derivatives waveforms at stator and rotor teeth angles ($90^\circ, 90^\circ$)

The optimum total EMF is about -14 V/unit current, i.e., double the corresponding value of fully-pitched unipolar excitation case and about four times the corresponding value produced by the conventional short-pitched 4/2 SRG having the same dimensions.

2) Three-Phase 6/4 SRG

From the results, the maximum produced total EMF per unit current is -10.6548 V at an optimal β_s, β_r pair ($45^\circ, 45^\circ$). This value is about two times the corresponding value of the conventional short-pitched 6/4 SRG with the same dimensions. The mutual inductances and its derivatives are shown in Fig.

22.

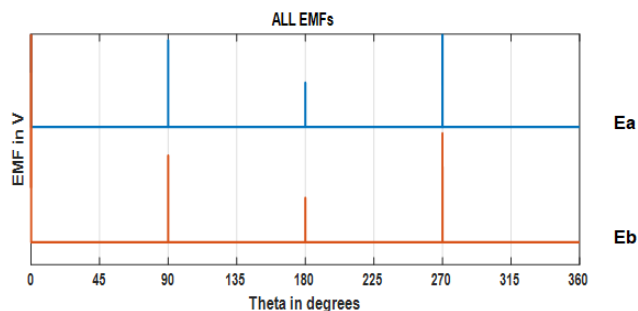

Fig. 20 Fully-pitched 4/2 SRG maximum output EMF E_a and E_b waveforms at stator and rotor teeth angles ($90^\circ, 90^\circ$)

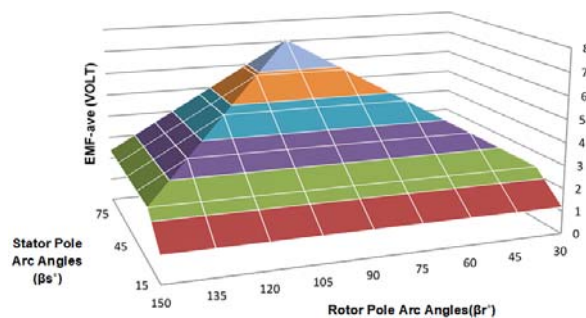

Fig. 21 The output EMF per phase per unit current versus β_s and β_r for 4/2 fully-pitched SRG: Bipolar, 2-phase excitation

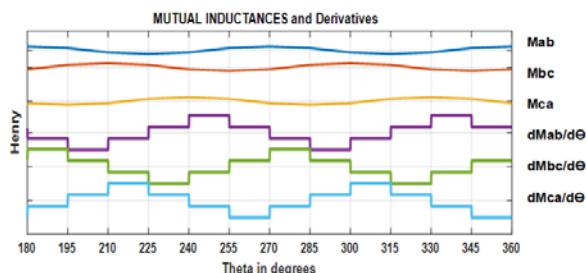

Fig. 22 Fully-pitched 6/4 SRG mutual inductances and its derivatives waveforms at stator and rotor teeth angles ($45^\circ, 45^\circ$)

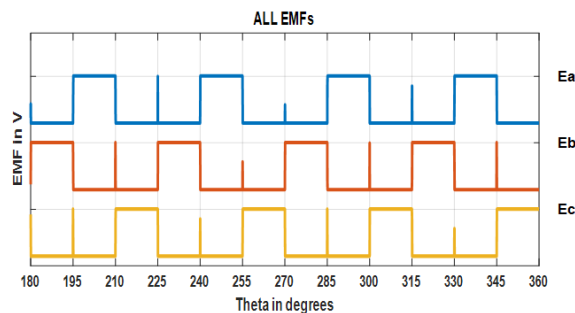

Fig. 23 Fully-pitched 6/4 SRG output EMF E_a, E_b and E_c waveforms at stator and rotor teeth angles ($45^\circ, 45^\circ$), Bipolar, 3-phase excitation

The excitation current pattern to generate the maximum EMF-wave at stator/rotor pole angles ($45^\circ, 45^\circ$):

$$I = \begin{bmatrix} 1 & 1 & 1 & -1 & -1 & -1 \\ -1 & -1 & 1 & 1 & 1 & -1 \\ 1 & -1 & -1 & -1 & 1 & 1 \end{bmatrix}$$

The waveform of the maximum EMF per phase per unit current is shown in Fig. 23.

Fig. 24 shows the maximum output total EMF dependency on stator/rotor pole angles.

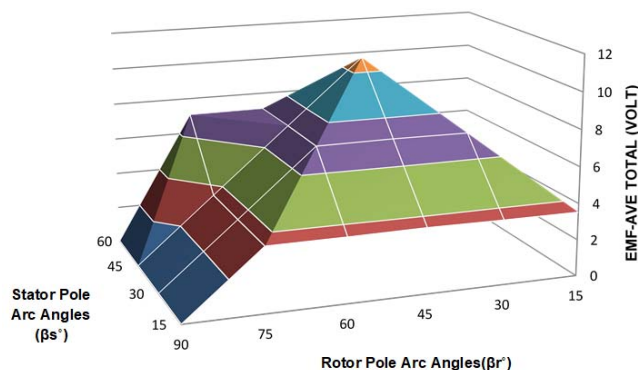

Fig. 24 The output total EMF per unit current versus β_s and β_r for 6/4 fully-pitched SRG: Bipolar, 3-phase excitation

3) Four-Phase 8/6 SRG

From the results, the maximum total EMF per unit current of about -42 V is produced at stator/rotor tooth angles (30°, 15°) and (15°, 30°). The output voltage of this case is about three times the maximum value produced in the case of the unipolar 2-phase excitation current pattern. The optimal chosen angles are (15°, 30°). This pole angles combination has an interesting property, as it allows a reduction of the stator tooth angle to 15° thereby allowing a larger copper area for the same EMF, with a 30° rotor tooth angle.

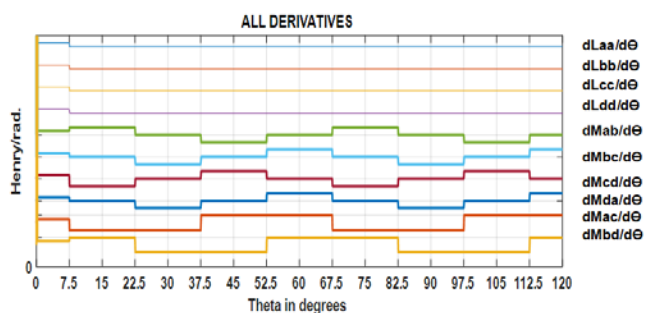

Fig. 25 Fully-pitched 8/6 SRG all derivatives waveforms at stator/rotor tooth angles (15°, 30°)

The 4-phase excitation current pattern is:

$$I = \begin{bmatrix} 0 & 1 & 1 & 0 & 0 & 1 & 1 & 0 & 0 \\ 1 & -1 & 0 & 1 & 1 & -1 & 0 & 1 & 1 \\ -1 & 1 & 1 & 0 & -1 & 1 & 1 & 0 & -1 \\ 1 & -1 & -1 & 1 & 1 & -1 & -1 & 1 & 1 \end{bmatrix}$$

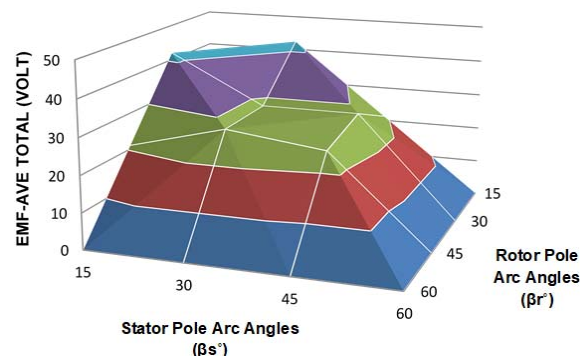

Fig. 26 Total EMF output values versus β_s and β_r . fully-pitched 8/6 SRG: Bipolar, 4-phase excitation

TABLE III
LINEAR ANALYSIS OPTIMUM RESULTS OF FULLY-PITCHED SRG POLE ANGLES WITH ASSOCIATED MAXIMUM VOLTAGE OUTPUTS

SRG	Coil Pitch, ρ	Excitation	$\beta_s^\circ/\beta_r^\circ$	Total EMF/unit current (V)
2phase, 4/2	Fully-pitched ($\rho = 2$)	Bipolar Two-phase	90°/90°	-7.08
3phase, 6/4	Fully-pitched ($\rho = 3$)	Bipolar Three-phase	45°/45°	-10.65
4phase, 8/6	Fully-pitched ($\rho = 4$)	Bipolar Four-phase	15°/30°	-42.4

VI. COMPARISON AND DISCUSSION

A unified matrix representation of the SRG has been used to determine the optimum rotor and stator pole arc angles which finally generate the maximum induced voltage. After applying the linear analysis procedures on the typical SRG configurations, as can be seen in Tables II and III, it has been found that:

- 1- The maximum total EMF-ave produced by 4/2 fully-pitched SRG, with bipolar 2-phase excitation is four times the corresponding EMF value produced by the conventional short-pitched SRG.
- 2- The fully pitched 6/4 SRG excited by bipolar 3-phase excitation technique produced double the value of the conventional three phase short-pitched SRG.
- 3- The fully-pitched 8/6 SRG with bipolar four phases excitation current achieved the best induced voltage overall, as the EMF-ave total was about six times the maximum value of the conventional four phase short-pitched SRG.

VII. CONCLUSION

To sum up, the optimum stator/rotor pole angles for the same machine dimensions and rotational speed are (15°, 30°) of the four phase 8/6 fully pitched SRG configuration, with a 4-phase bipolar excitation current pattern. This pole angle combination has the advantage of increased copper utilization area for the same machine volume while providing a continuous maximum inductance derivative profile, hence induced voltage. Thus, it is the recommended design for further machine non-linear analysis and implementation. Linear analysis approach has been proved to be a feasible tool used to analyze SRG

performance and set the optimum design that can be considered as a starting point for FE-based SRG design.

REFERENCES

- [1] D. Susitra, E. A. E. Jebaseeli and S. Paramasivam, "Switched Reluctance Generator - Modeling, Design, Simulation, Analysis and Control A Comprehensive Review," *International Journal of Computer Applications*, vol. 1, no. 2, p. 0975 – 8887, 2010.
- [2] F. A., A. D.A., S. A. W. F. V., R. P. H. F., M. F. S. L. F., M. L. A. G., D. D. N. and O. J. L., "Wind Powered Switched Reluctance Generator for Rural Properties and Small Communities," in *International Conference on Renewable Energies and Power Quality (ICREPQ'10)*, Garnada, Spain, 2010.
- [3] D. A. Torrey, "Switched reluctance generators and their control," *IEEE Transactions on Industrial Electronics*, vol. 49, no. 1, pp. 3 - 14, 2002.
- [4] K. Mtronix, "<http://kaskod.com/products-services/switched-reluctance-generators/>," Kaskod Mtronix, 2020. (Online).
- [5] T. A. d. S. Barros, A. J. S. Filho and E. R. Filho, "Direct Power for Switched Reluctance Generator in Wind Energy," in *Modeling and Control Aspects of Wind Power Systems*, INTECH OPEN, 2013, pp. 39-60.
- [6] A. Arifin and I. Al-Bahadly, "Switched Reluctance Generator for Variable Speed Wind Energy Applications," *Smart Grid and Renewable Energy*, pp. 27-36, January 2011.
- [7] A. Siadatan, V. Najmi and E. Afjei, "Modeling, Simulation and Analysis of A Novel Two Layer 8/6 Hybrid Switched Reluctance Motor/Field-Assisted Generator," in *20th Iranian Conference on Electrical Engineering (ICEE2012)*, Tehran, Iran, May 2012.
- [8] A. E., A. M., S. A. and B. H., "Simulation and experimental verification of input/output currents in a stand-alone switched reluctance generator for different speeds," in *Electrical Machines and Power Electronics and Electromotion Joint Conference (ACEMP)*, 2011.
- [9] J. Sun, S. Wang, Z. Wei, Q. Zhan and Z. Ma, "Study for generating operation of three-phase fully-pitched winding switched reluctance machine," in *International Conference on Electrical Machines and Systems*, Wuhan, China, 2008.
- [10] J. F. a. B. W. W.A.M. Ghoneim, "Linear analysis of two-, three- and four-phase switched reluctance machines with variable pitched winding configurations," *IEE Proc.-Electr. Power Appl.*, vol. 150, no. 3, pp. 319-343, May 2003.
- [11] W. Ghoneim, J. Fletcher and B. Williams, "Matrix approach for the generalized theory of doubly-salient reluctance machines," *IEE Proc.-Electr. Power Appl.*, Vols. 149, no. 1, no. 1, pp. 65-80, January 2002.