

Affordable and Environmental Friendly Small Commuter Aircraft Improving European Mobility

Diego Giuseppe Romano, Gianvito Apuleo, Jiri Duda

Abstract—Mobility is one of the most important societal needs for amusement, business activities and health. Thus, transport needs are continuously increasing, with the consequent traffic congestion and pollution increase. Aeronautic effort aims at smarter infrastructures use and in introducing greener concepts. A possible solution to address the abovementioned topics is the development of Small Air Transport (SAT) system, able to guarantee operability from today underused airfields in an affordable and green way, helping meanwhile travel time reduction, too. In the framework of Horizon2020, EU (European Union) has funded the Clean Sky 2 SAT TA (Transverse Activity) initiative to address market innovations able to reduce SAT operational cost and environmental impact, ensuring good levels of operational safety. Nowadays, most of the key technologies to improve passenger comfort and to reduce community noise, DOC (Direct Operating Costs) and pilot workload for SAT have reached an intermediate level of maturity TRL (Technology Readiness Level) 3/4. Thus, the key technologies must be developed, validated and integrated on dedicated ground and flying aircraft demonstrators to reach higher TRL levels (5/6). Particularly, SAT TA focuses on the integration at aircraft level of the following technologies [1]: 1) Low-cost composite wing box and engine nacelle using OoA (Out of Autoclave) technology, LRI (Liquid Resin Infusion) and advance automation process. 2) Innovative high lift devices, allowing aircraft operations from short airfields (< 800 m). 3) Affordable small aircraft manufacturing of metallic fuselage using FSW (Friction Stir Welding) and LMD (Laser Metal Deposition). 4) Affordable fly-by-wire architecture for small aircraft (CS23 certification rules). 5) More electric systems replacing pneumatic and hydraulic systems (high voltage EPGDS -Electrical Power Generation and Distribution System-, hybrid de-ice system, landing gear and brakes). 6) Advanced avionics for small aircraft, reducing pilot workload. 7) Advanced cabin comfort with new interiors materials and more comfortable seats. 8) New generation of turboprop engine with reduced fuel consumption, emissions, noise and maintenance costs for 19 seats aircraft. (9) Alternative diesel engine for 9 seats commuter aircraft. To address abovementioned market innovations, two different platforms have been designed: Reference and Green aircraft. Reference aircraft is a virtual aircraft designed considering 2014 technologies with an existing engine assuring requested take-off power; Green aircraft is designed integrating the technologies addressed in Clean Sky 2. Preliminary integration of the proposed technologies shows an encouraging reduction of emissions and operational costs of small: about 20% CO₂ reduction, about 24% NO_x reduction, about 10 db (A) noise reduction at measurement point and about 25% DOC reduction. Detailed description of the performed studies, analyses and

Diego Giuseppe Romano is with Piaggio Aero Industries S.p.A., Villanova d'Albenga (SV), 17038, Italy (phone: 0039 0823 623775; e-mail: dromano@piaggioaerospace.it).

Gianvito Apuleo is with Piaggio Aero Industries S.p.A., Villanova d'Albenga (SV), 17038, Italy (phone: 0039 0823 623776; e-mail: gapuleo@piaggioaerospace.it).

Jiri Duda is with Evektor, spol. s r.o., Kunovice, 686 04 Czech Republic (phone: 00420 572 537 442; fax: 00420 572 537 901; e-mail: jduda@evektor.cz).

validations for each technology as well as the expected benefit at aircraft level are reported in the present paper.

Keywords—Affordable, European, green, mobility, technologies development, travel time reduction.

I. INTRODUCTION

THIS paper describes the main characteristics of both the Reference and the Green 19 seats commuter aircraft developed inside Clean Sky 2 SAT TA.

Clean Sky 2's intention is to boost a range of SAT technologies that have stagnated at TRL3 or 4 and advance them through further research and experimental demonstration.

The aircraft and systems manufacturers already on-board within Clean Sky 2 propose to develop, validate and integrate key technologies on dedicated ground demonstrators and flying aircraft demonstrators at an ITD (Integrated Technology Demonstrator) level. By doing so, the Clean Sky 2 ecosystem can engage with the wider supply chain and industry that supplies to this sector of aviation, pulling in new capabilities from other sectors that can provide new impetus such as from the worlds of automotive and electronics. Within this context, the main impact on the performances and on the environment of most promising technologies affordable for Small aircraft is analysed at aircraft level toward the integration into the Green 19 seats A/C (aircraft). Subsequently, the reference mission for the assessed aircraft is described, together with the noise and emissions metrics used.

Finally, the results of the first assessment are shown in terms of trajectories, certification noise, noise footprints, fuel burn, emissions and costs.

II. TOP LEVEL AIRCRAFT REQUIREMENTS (TLAR)

TLAR are the same for both the Reference and the Green aircraft.

The certification basis for the aircraft is the CS-23 (Certification Specification 23) [2]/FAR-23 (Federal Aviation Regulations) Commuter Category Requirements [3].

The requirements and objectives presented hereafter have been defined based on market analysis prepared inside Clean Sky 2 SAT TA [4]-[6].

TLAR provide input for preliminary design activities with the aim to define both the reference A/C, to be used as baseline for the evaluation of Clean Sky 2 SAT technologies at A/C level, and Green aircraft developed during the project.

The aircraft is a twin turbo propeller airplane and shall be designed to carry passengers, cargo or both (combi version)

and special missions (Medevac configuration, Paratroop configuration, Maritime Patrol configuration).

Main TLAR are reported in Table I, where the following acronyms have been introduced: 1) AEO = All Engine Operative. 2) ICAO = International Civil Aviation Organization. 3) ISA = International Standard Atmosphere. 4) KTAS = knots. 5) MLW = Maximum Landing Weight. 6) MTOW = Maximum Take-Off Weight. 7) OEI = One Engine Inoperative. 8) Pax = passengers. 9) SL = sea level.

III. 19-SEATS REFERENCE AIRCRAFT

Reference aircraft is a virtual airplane, designed considering 2014 technologies, with a 2014 existing engine assuring the requested power to complete A/C mission. Reference A/C is used as a to verify the improvements of the main technologies developed for the Green A/C.

Reference A/C is a high wing, low-tail twin engine turboprop inspired from actual 19 pax aircraft fleet, which has been proven to be very successful. Fig. 1 shows the three-view of the Reference A/C, whereas Fig. 2 depicts the cabin cross section. Tables II and III report, respectively, main

geometrical data and design weights. In Table III the following acronyms have been introduced: 1) OEW = Operative Empty Weight. 2) MLW = Maximum Landing Weight. 3) MZFW = Maximum Zero Fuel Weight.

TABLE I
 LIST OF TOP LEVER AIRCRAFT REQUIREMENTS

TLAR #	Requirement	Value
1	passenger capacity	19 pax @ 31"
2	design range	800 nm – 19 pax @ 100 kg each (87 kg per passenger/crew member + 13 kg baggage per passenger or crew member)
3	long range cruise speed	195 KTAS @ 97%MTOW 10000 ft
4	max cruise speed	230 KTAS @ 97%MTOW 10000 ft
5	climb [97%MTOW @ SL, ISA, OEI]	> 600 fpm
6	climb [97%MTOW @ SL, ISA, AEO]	> 2150 fpm
7	max payload (structural)	3,000 kg (cargo configuration) or 19 pax @ 87 kg + 13 kg/pax baggage (1900 Kg)
8	take-off field length	< 800 m [@ MTOW, SL, ISA]
9	landing	< 780 m [@ MLW, SL, ISA]
10	external noise	ICAO chapter 10 -10 dB(A)

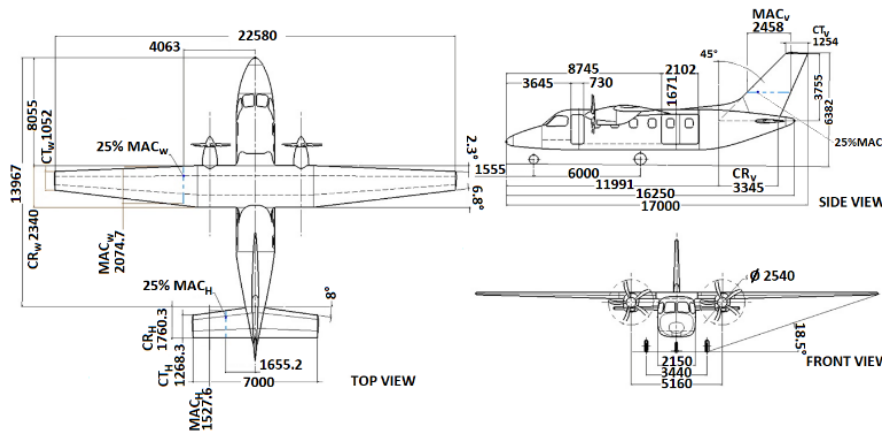

Fig. 1 Reference A/C three-view

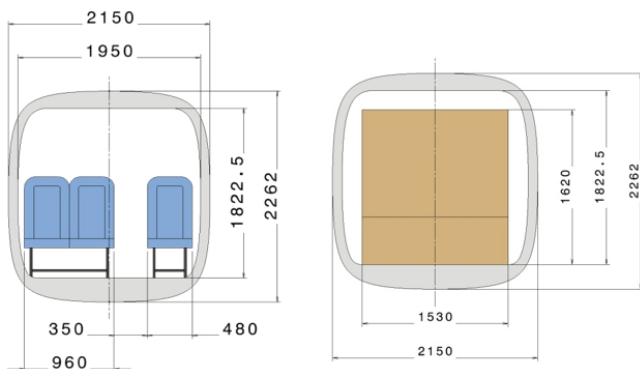

Fig. 2 Reference A/C cabin cross section in passenger configuration (left side) and cargo configuration (right side)

IV. 19-SEATS GREEN AIRCRAFT

Green aircraft is a high wing, with winglets, low-tail twin engine turboprop, with retractable landing gear, inspired from

actual 19 pax aircraft fleet. Fig. 3 shows Green A/C three-view, whereas Fig. 4 depicts its cabin cross section.

TABLE II
 REFERENCE A/C MAIN EXTERNAL DIMENSIONS

Dimension	Value
Wing span	22.60 m
Wing area	42.52 m ²
Overall length	17.00 m

TABLE III
 REFERENCE A/C DESIGN WEIGHTS

Weight	Value
MTOW	8435 kg
MLW	8435 kg
MZFW	7700 kg
OEW	5000 kg
Max fuel	2600 kg
Design payload	1729 kg

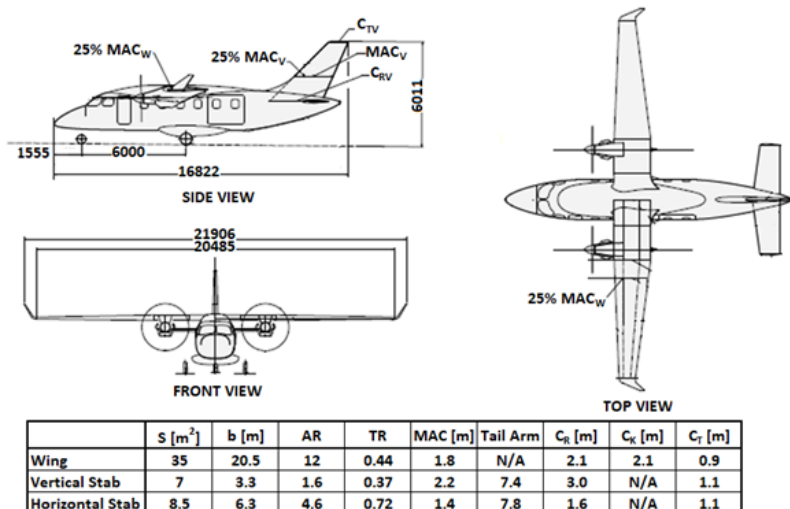

Fig. 3 Green A/C three-view

TABLE IV
REFERENCE A/C MAIN EXTERNAL DIMENSIONS

Dimension	Value
Wing span	20.50 m (-9%)
Wing area	35.00 m ² (-18%)
Overall length	16.38 m (-4%)

TABLE V
REFERENCE A/C DESIGN WEIGHTS

Weight	Value
MTOW	7755 kg (-8%)
MLW	7755 kg (-8%)
MZFW	7450 kg (-3%)
OEW	4750 kg (-5%)
Max fuel	2600 kg (0%)
Design payload	1729 kg (0%)

TABLE VI
REFERENCE A/C DESIGN WEIGHTS

	Integrated technology	Expected benefit over conventional technology
Low cost manufacturing technology:	1) Low cost composite wing box and engine nacelle using OoA technology, LRI and advance automation process. 2) Affordable small aircraft manufacturing of metallic fuselage by means of FSW and LMD.	1) -20% recurring Cost. 2) -3% Total Operating Cost.
Low fuel consumption and reduced maintenance:	Use of advanced turboprop engine with reduced fuel consumption, emissions and maintenance costs for 19 seats aircraft.	-20% on Total Operating Cost: 1) 6% fuel. 2) 8% engine maintenance. 3) 6% systems maintenance.
Reduced pilot workload improving safety:	Advanced avionics for small aircraft, to reduce pilot workload, paving single pilot operations for 19 seats.	1) -6% Total Operating Cost (single pilot operations). 2) 10 times fatal accident reduction.
Reduced community noise:	Improved power-plant noise emissions.	-10 dB(A).
Improve pax comfort:	1) Use of materials for sound absorbing trim panels. 2) Passenger seat system improvement. 3) Increase high lift performance to reduce wing area.	1) -20% recurring Cost. 2) -3% Total Operating Cost.

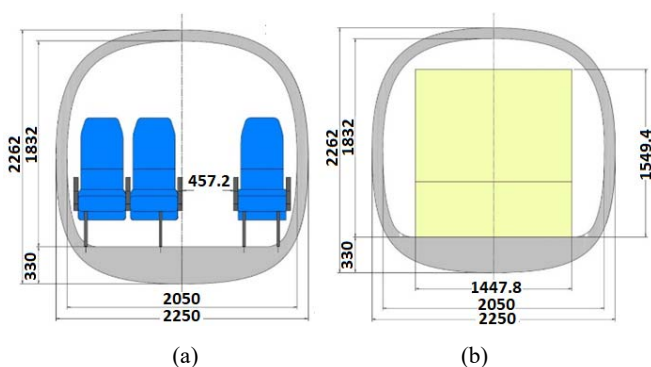

Fig. 4 Green A/C cabin cross section in passenger configuration (a) and cargo configuration (b)

Tables IV and V report, respectively, main geometrical data and design weights as well as the percentage difference with respect to the Reference A/C values in round brackets.

Table VI shows the integrated technologies used to design the Green A/C, their main effects on the aircraft as well as the envisaged expected benefits with respect to the Reference A/C.

V. A/C REFERENCE MISSION

The mission of both the Reference and the Green aircraft is the same and consists of the following phases, see Fig. 5:

- 1) Ground operations.
- 2) Take-off up to 1.500 ft.
- 3) Acceleration at 1.500 ft up to 150 KTAS.
- 4) Climb at constant speed (150 KTAS) up to 10.000 ft.
- 5) Acceleration at 10.000 ft up to cruise speed.
- 6) Cruise at 10.000 ft at constant speed (two missions have been analyzed: at 195 and 230 KTAS).
- 7) Deceleration at 10.000 ft down to 120 KTAS.
- 8) Descent at constant speed of 120 KTAS down to 1.500 ft.

- 9) Deceleration at constant altitude of 1.500 ft down to 113 KTAS.
- 10) Landing.
- 11) Ground operations.

Reserves are included as follows:

- 1) 30 min @ 1500 ft above destination (or destination alternate).
- 2) Max 5% trip fuel or 5 min.
- 3) 100 nm alternate (including climb, cruise, descent to destination alternate).

VI. ASSESSMENT OF RESULTS

A. Aircraft Trajectories

Fig. 6 shows the trajectories (excluding reserve) for both the Reference and the Green A/C for the 300 nm mission analyzed by using a dedicated simulation model developed inside Clean Sky project.

This simulation model is based on the implementation of aircraft equation of motion and noise equations in a software organized in a modular way to manage inputs (aerodynamic data, aircraft geometric data, engine deck, mission profile, noise matrix). The output in terms of performance analysis is a text file containing main characteristics of each mission phase and summary tables reporting, for each mission phase, time travelled, range covered, fuel consumed, CO₂ and NO_x produced. The output in terms of noise analysis is a series of files and pictures containing noise footprint values in terms of LA (A-weighted sound Level), L_{Amax}, SEL (Sound Exposure Level) and EPNL (Effective Perceived Noise Level).

It can be seen that the trajectories of both aircraft are the same, with minimum differences in the climb and descent phase due to the improved A/C aerodynamic coupled with improved power-plant.

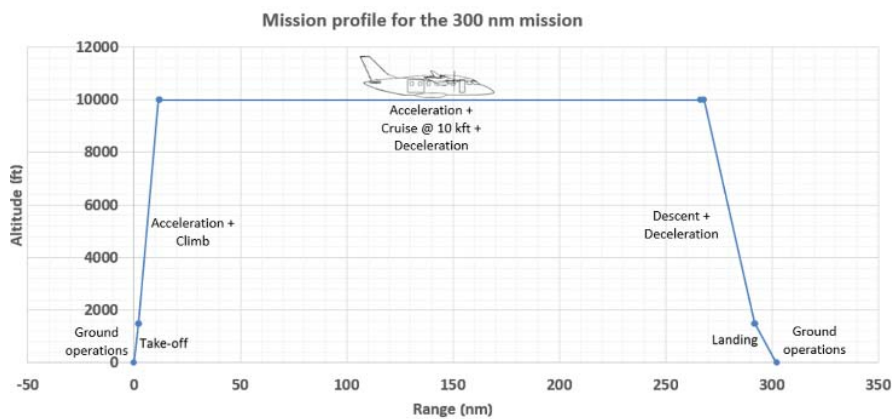

Fig. 5 Design mission

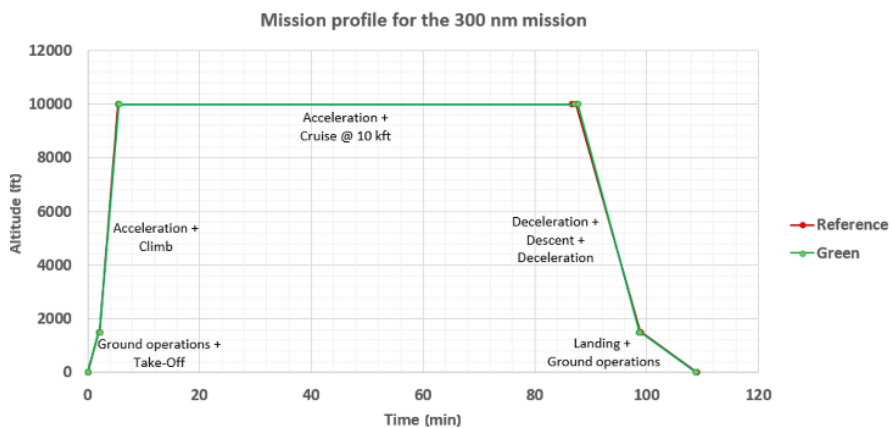

Fig. 6 Reference vs Green mission profiles

B. Noise Analysis

Certification requirements for the 19 seats aircraft class are linked to the perceived noise at a point located at 2.5 km from brake release point (see Fig. 7) [7]. The maximum allowed noise value for certification is 88 dB(A). Table VII shows the comparison in terms of noise emission at the certification point for the Reference and the Green aircraft.

Additional noise analyses have been carried out to determine SEL values for both Reference and Green A/C. SEL takes into account all the acoustic energy of an individual noise event as if that event had occurred within a period of one-second. SEL metric is able to capture both the magnitude and the duration of the sound event, providing a uniform way to compare different noise events of various duration.

TABLE VII
NOISE LEVELS AT CERTIFICATION POINT

Phase	Reference	Green
Take-Off	81.1	71.3

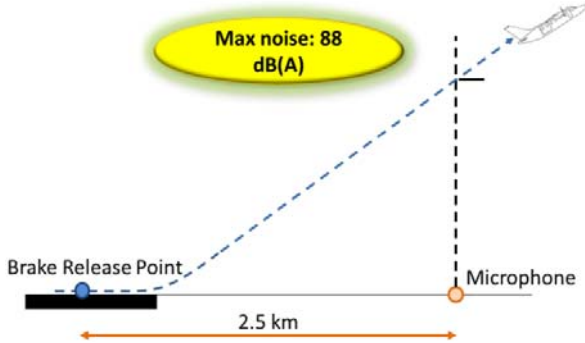

Fig. 7 Noise certification point for small commuters

Figs. 7 and 8 show, respectively, the SEL contour map for the Reference and the Green aircraft, while Table VIII reports the noise footprint areas and the relative difference between the two types of aircraft considered.

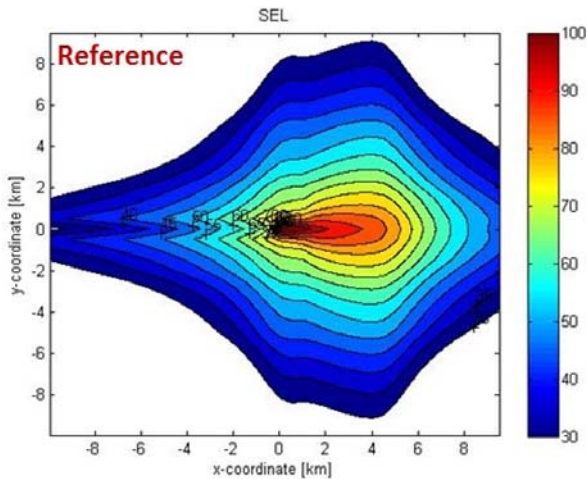

Fig. 7 SEL footprint for the Reference A/C

C. Fuel Burn and Emissions

Several missions have been analyzed in order to assess CO₂ and NO_x emission reduction, varying the mission range (200, 300, 400, 600 and 800 nm) and cruise speed (195 and 230 KTAS). For each one of the analyzed missions, CO₂ and NO_x emissions have been assessed on the basis of the knowledge of the amount of pollutant released per unit of fuel burn [8]-[12]. Emission indexes have been provided by engine manufacturers for the requested conditions: max take-off, max climb, cruise (at several engine ratings) and ground idle.

Tables IX and X show the results of the analysis, respectively of the reference and green A/C for the missions at 195 KTAS, in terms of block fuel (it includes fuel needed for taxi-out (10 kg), take-off, climb, cruise, descent, landing and taxi-in (10 kg)), block time (it includes time needed for taxi-out (5 min), take-off, climb, cruise, descent, landing and taxi-

in (10 min)), and block fuel per passenger.

Tables XI and XII show the results of the analysis, respectively of the reference and green A/C for the missions at 230 KTAS, in terms of block fuel, block time, and block fuel per passenger.

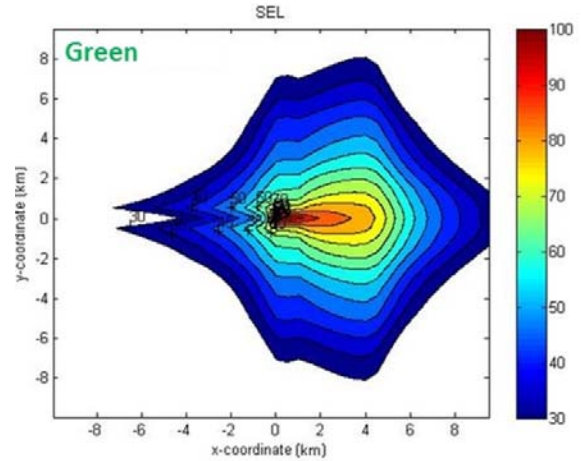

Fig. 8 SEL footprint for the Green A/C

TABLE VIII
NOISE FOOTPRINT AREA

SEL	Reference	Green	Relative difference
55 db(A)	66.06 m ²	34.35 m ²	-48%
60 db(A)	48.18 m ²	23.90 m ²	-50%
65 db(A)	34.72 m ²	16.09 m ²	-54%
70 db(A)	24.27 m ²	9.88 m ²	-59%
75 db(A)	16.20 m ²	5.53 m ²	-66%
80 db(A)	10.00 m ²	2.14 m ²	-79%
85 db(A)	5.75 m ²	0.67 m ²	-88%
90 db(A)	2.46 m ²	0.24 m ²	-90%
95 db(A)	0.85 m ²	0.03 m ²	-96%
Average relative difference	23.17 m ²	10.31 m ²	-55%

TABLE IX

RESULTS AT DESIGN PAYLOAD AT 195 KTAS FOR REFERENCE A/C

Mission (nm)	200	300	400	600	800
Block fuel (kg)	385.8	535.1	685.0	986.2	1289.6
Block time (min)	93.2	124.0	154.9	216.5	278.2
Block fuel/pax (kg/pax)	20.3	28.2	36.1	51.9	67.9

TABLE X

RESULTS AT DESIGN PAYLOAD AT 195 KTAS FOR GREEN A/C

Mission (nm)	200	300	400	600	800
Block fuel (kg)	312.0	428.0	544.5	778.9	1015.3
Block time (min)	93.0	123.8	154.7	216.3	278.0
Block fuel/pax (kg/pax)	16.4	22.5	28.7	41.0	53.4

TABLE XI

RESULTS AT DESIGN PAYLOAD AT 230 KTAS FOR REFERENCE A/C

Mission (nm)	200	300	400	600	800
Block fuel (kg)	408.2	569.9	731.9	1057.3	1384.3
Block time (min)	85.8	111.9	138.1	190.4	242.6
Block fuel/pax (kg/pax)	21.5	30.0	38.5	55.6	72.8

Tables XIII and XIV show the results of the analysis,

respectively of the reference and green A/C for the missions at 195 KTAS, in terms of CO₂ and NO_x emissions. Tables XV and XVI show the results of the analysis, respectively of the reference and green A/C for the missions at 230 KTAS, in terms of CO₂ and NO_x emissions.

TABLE XII
RESULTS AT DESIGN PAYLOAD AT 230 KTAS FOR GREEN A/C

Mission (nm)	200	300	400	600	800
Block fuel (kg)	336.0	466.3	597.0	859.6	1124.2
Block time (min)	85.3	111.5	137.6	189.9	242.2
Block fuel/pax (kg/pax)	17.7	24.5	31.4	45.2	59.2

TABLE XIII
EMISSIONS AT DESIGN PAYLOAD AT 195 KTAS FOR REFERENCE A/C

Mission (nm)	200	300	400	600	800
CO ₂ (kg)	1124.4	1589.5	2056.5	2994.9	3940.2
NO _x (kg)	1.41	2.08	2.75	4.10	5.48

TABLE XIV
EMISSIONS AT DESIGN PAYLOAD AT 195 KTAS FOR GREEN A/C

Mission (nm)	200	300	400	600	800
CO ₂ (kg)	926.4	1288.0	1651.3	2381.6	3118.4
NO _x (kg)	1.09	1.58	2.08	3.07	4.09

TABLE XV
EMISSIONS AT DESIGN PAYLOAD AT 230 KTAS FOR REFERENCE A/C

Mission (nm)	200	300	400	600	800
CO ₂ (kg)	1194.1	1698.0	2202.7	3216.6	4235.4
NO _x (kg)	1.86	2.79	3.73	5.63	7.55

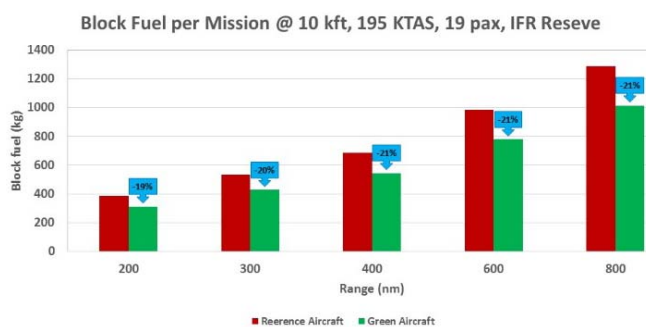

Fig. 9 Block fuel per mission comparison between Reference and Green A/C for the mission at 195 KTAS

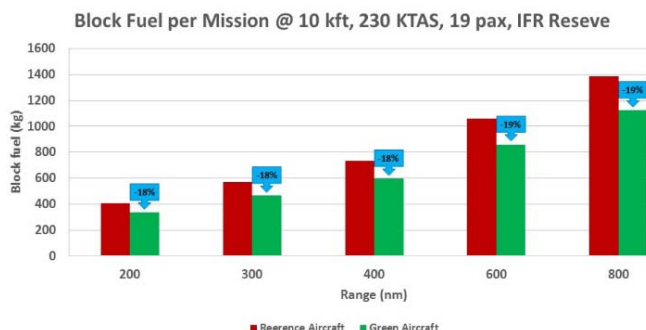

Fig. 10 Block fuel per mission comparison between Reference and Green A/C for the mission at 230 KTAS

Figs. 9-14 show the comparison between block fuel, CO₂

and NO_x emissions for both the Reference and the Green A/C.

TABLE XVI
EMISSIONS AT DESIGN PAYLOAD AT 230 KTAS FOR GREEN A/C

Mission (nm)	200	300	400	600	800
CO ₂ (kg)	999.6	1404.8	1811.2	2628.0	3450.8
NO _x (kg)	1.41	2.10	2.78	4.17	5.57

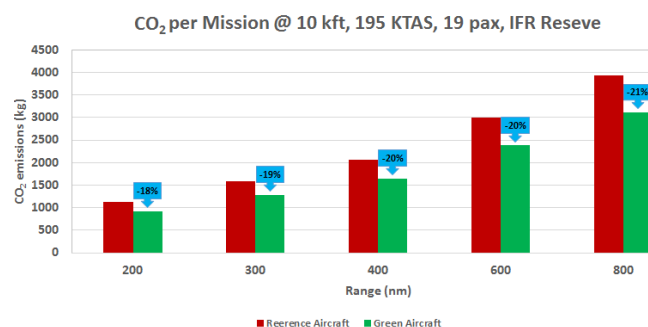

Fig. 11 CO₂ per mission comparison between Reference and Green A/C for the mission at 195 KTAS

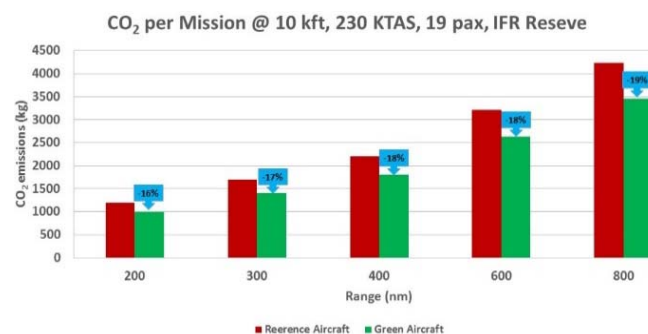

Fig. 12 CO₂ per mission comparison between Reference and Green A/C for the mission at 230 KTAS

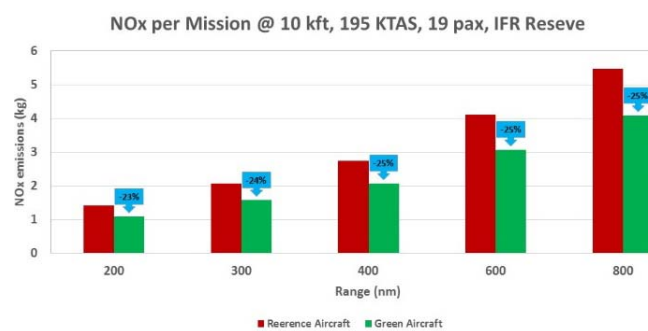

Fig. 13 NO_x per mission comparison between Reference and Green A/C for the mission at 195 KTAS

D. Cost Analysis

Travel costs are of paramount importance in the final passenger choice, thus it is requested, together with the introduction of greener concept, to develop affordable aircraft.

Both Reference and Green A/C configurations' costs have been derived by applying standard cost procedures valid for aircraft [13]. In particular, costs for both the Reference and the Green A/C are divided into:

- 1) DOC: these costs are directly linked to the operation of

the aircraft (i.e. flight crew, fuel, ownership, insurance and maintenance).

- 2) Indirect Operating Costs (IOC): these costs are all the other costs to operate an aircraft (i.e. advertising and publicity, aircraft servicing, amortization and transport related depreciation on maintenance equipment, passenger service, reservation and sales, traffic servicing).

between the homologous costs of the two configurations analyzed. Fig. 20 shows the fare per seat/km for several transport (car values are considered with a load factor of 1.4, while train figures are mean values considering several Countries), while Fig. 21 shows its breakdown per macro-item.

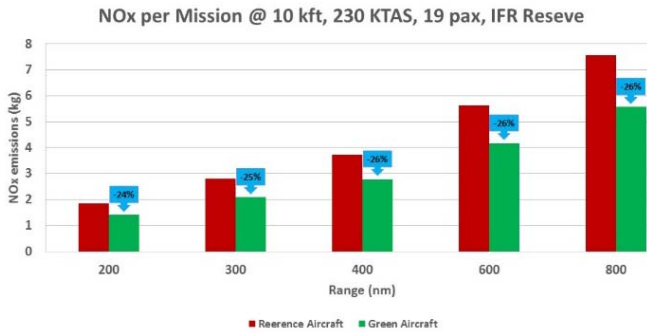

Fig. 14 NO_x per mission comparison between Reference and Green A/C for the mission at 230 KTAS

REFERENCE A/C DIRECT OPERATING COSTS

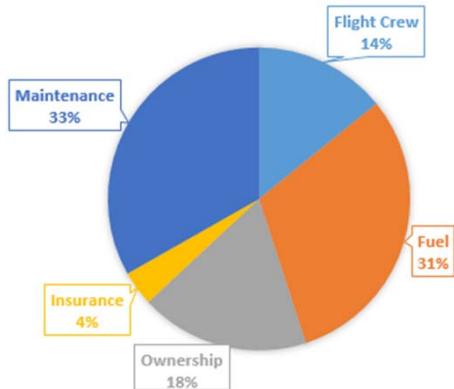

Fig. 15 DOC for Reference A/C

GREEN A/C DIRECT OPERATING COSTS

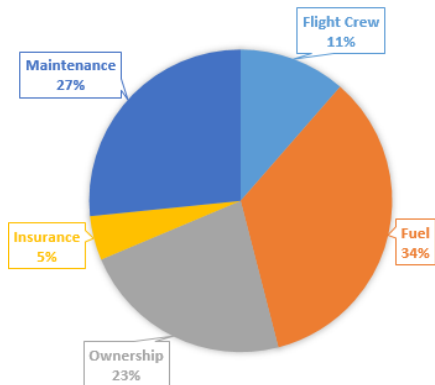

Fig. 16 DOC for Green A/C

REFERENCE A/C INDIRECT OC

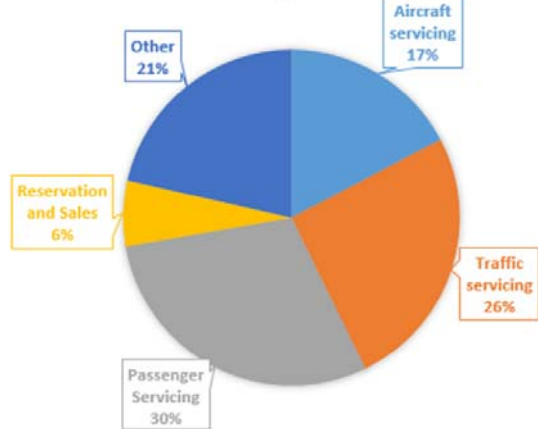

Fig. 17 IOC for Reference A/C

GREEN A/C INDIRECT OC

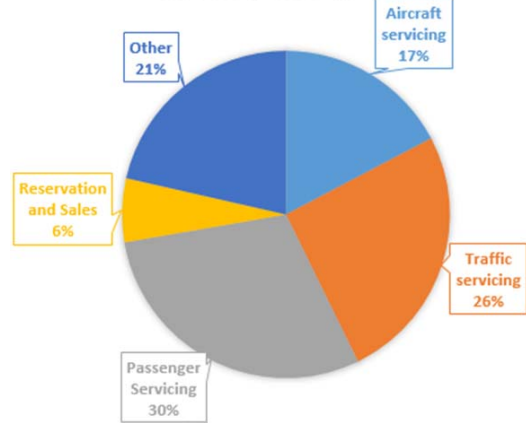

Fig. 18 IOC for Green A/C

Figs. 15-18 show the DOC and IOC for both Reference and Green A/C. Fig. 19 shows DOC breakdown for both Reference and Green A/C, including the percentage difference

VII. CONCLUSION

The present report describes the main characteristics and performances of the Reference and the Green 19 seats commuter aircraft development inside the SAT TA, including the integrated technologies developed in the framework of Horizon2020 Clean Sky 2 project.

A focus on noise and pollutant emission reduction of the Green compared to the Reference A/C for the several missions analyzed is provided.

The results show that:

- 1) Both the block fuel and CO₂ reduction of the Green A/C with respect to the Reference aircraft is about 20% at 195 KTAS and 18% at 230 KTAS.
- 2) NO_x emission reduction of the Green A/C with respect to the Reference aircraft is about 25% at 195 KTAS and 24% at 230 KTAS.

- 3) Noise emission at the microphone for the Green A/C is about 71 dB(A), against 81 dB(A) for the Reference aircraft.
- 4) The introduction of Clean Sky 2 technologies produces a reduction of fare per seat/km equal to about 25-28%, whose breakdown is the following:
 - a. Maintenance reduction: about 50%.
 - b. Fuel reduction: about 20%.
 - c. Flight crew reduction: about 20%.
 - d. Ownership reduction: about 8%.
 - e. Insurance reduction: about 2%.

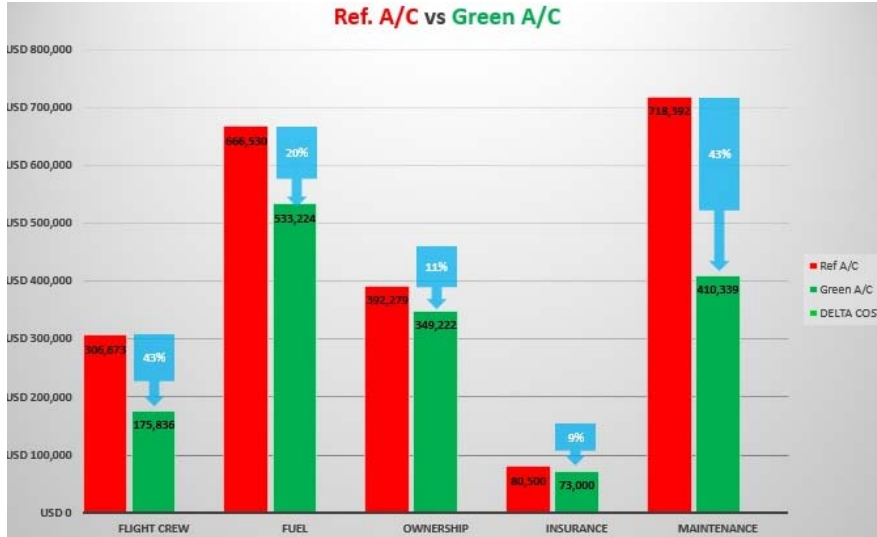

Fig. 19 Costs

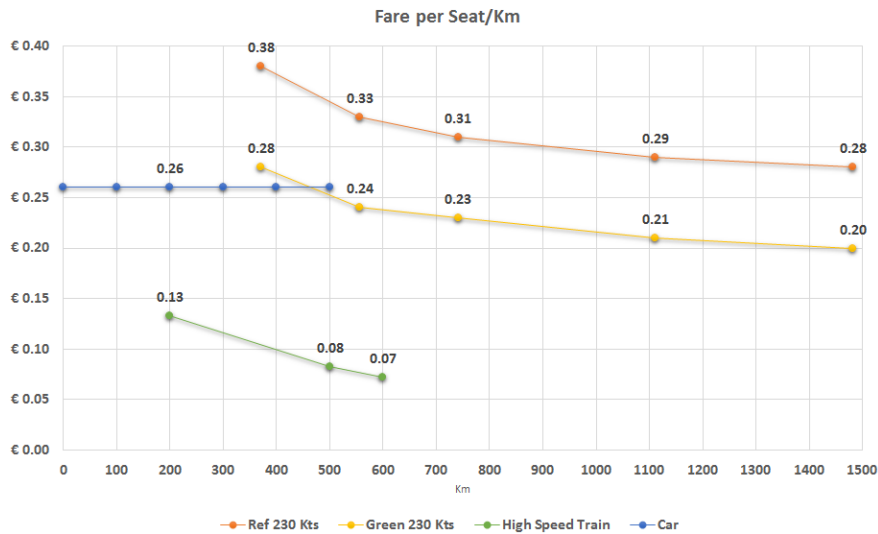

Fig. 20 Fare per seat/km

Operating Cost Reduction

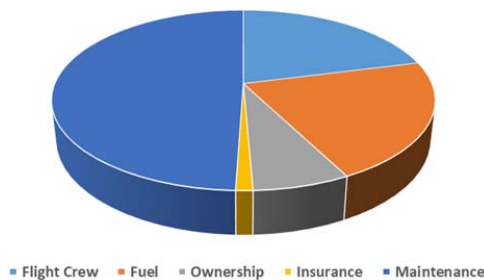

Fig. 21 Operating Cost Reduction breakdown

ACKNOWLEDGMENT

The project leading to this application has received funding from the Clean Sky 2 Joint Undertaking under the European Union's Horizon 2020 research and innovation programme under grant agreement No SAT GAM 2019 – GA n. 807088 and SAT GAM 2020 n.945500.

The authors would like to thank all the partners involved in the development of the technologies integrated in the 19 seats Green commuter aircraft and Dr. Eng. Antonello Marino, CS-JU Project Officer of SAT, for the support provided during the project execution and for the guidelines provided in the

realization of the present work.



DISCLAIMER

The present paper reflects only the author's view and H2020/Clean Sky 2 is not responsible for any use that may be made of the information it contains.

REFERENCES

- [1] D. G. Romano, G. Apuleo, R. A. Bertone, E. Chiapponi, P. D'Alesio, A. Ferraris, R. Rebagliati, G. Sereno, G. Travostino, P. Guła, A. Nathan, A. Sawday, "Environmental Friendly And Affordable Small Aircraft Transport To Improve European Network", Aerospace Europe Conference 2020, Bordeaux (FRA), February 25th-28th 2020.
- [2] "Certification Specifications for Normal, Utility, Aerobatic, and Commuter Category Aeroplanes CS-23," Amendment 5, 29 March 2017, EASA – European Aviation Safety Agency.
- [3] https://www.ecfr.gov/cgi-bin/text-idx?SID=685dc1ae97ae3f5e5569e47880fab01e&mc=true&node=pt14.1.23#_top.
- [4] M. Drexler, A. Wong, O. Wyman, "Infrastructure Investment Policy Blueprint: Country Performance Assessment", World Economic Forum, 2004. *An Introduction to Signal Detection and Estimation*. New York: Springer-Verlag, 1985, ch. 4.
- [5] T. Larsen, "Skylander Aircraft Market Appendix Turboprop Market Forecast March 2010", NEXA Advisors, LLC.
- [6] T. Larsen, "Global Market Outlook and Analysis For Turboprop Market To Support Financing of NEXA Capital Partners, LLC NEXA Capital powers the industry Skylander SK-105", NEXA Advisors, LLC.
- [7] Annex 16 to the Convention on International Civil Aviation, Environmental Protection, Volume I – Aircraft Noise, Chapter 10, ICAO.
- [8] F. Jelinek, A. Quesne, S. Carlier, "THE Free Route Airspace Project (FRAP) Environmental Benefit Analysis", Environmental Studies Business Area EUROCONTROL Experimental Centre, EEC / BA / ENV / Note 004/2002.
- [9] S. L. Baughcum, T. G. Tritz, S. C. Henderson, D. C. Pickett, "Scheduled Civil Aircraft Emission Inventories for 1992: Database Development and Analysis", NASA Contractor Report 4700, April 1996.
- [10] D. K. Wasiuk, M. A. H. Khan, D. E. Shallcross, M. H. Lowenberg, "A commercial Aircraft Fuel Burn and Emissions Inventory for 2005-2011", *Atmosphere* 2016, 7, 78.
- [11] U. Schumann, "Aircraft Emissions", Volume 3, Causes and consequences of global environmental change, Edited by Pr. I. Douglas, in *Encyclopedia of Global Environmental Change* (ISBN 0-471—97796-9), John Wiley & Sons, Ltd, Chichester, 2002.
- [12] J. A. Johnson, "Measuring Conventional and Alternative Exhaust Emissions from a Gas Turbine Engine", Submitted to the graduate degree program in Civil, Environmental, and Architectural Engineering and the Graduate Faculty of the University of Kansas in partial fulfillment of the requirements for the degree of Master of Science, 2012.
- [13] J. Roskam, "Airplane Design, Part VIII: Airplane Cost Estimation: Design, Development, Manufacturing and Operating", DARcorporation first printing: 1990.