

Evaluation of Seismic Behavior of Steel Shear Wall with Opening with Hardener and Beam with Reduced Cross Section under Cycle Loading with Finite Element Analysis Method

Masoud Mahdavi

Abstract—During an earthquake, the structure is subjected to seismic loads that cause tension in the members of the building. The use of energy dissipation elements in the structure reduces the percentage of seismic forces on the main members of the building (especially the columns). Steel plate shear wall, as one of the most widely used types of energy dissipation element, has evolved today, and regular drilling of its inner plate is one of the common cases. In the present study, using a finite element method, the shear wall of the steel plate is designed as a floor (with dimensions of $447 \times 6/246$ cm) with Abacus software and in three different modes on which a cyclic load has been applied. The steel shear wall has a horizontal element (beam) with a reduced beam section (RBS). The hole in the interior plate of the models is created in such a way that it has the process of increasing the area, which makes the effect of increasing the surface area of the hole on the seismic performance of the steel shear wall completely clear. In the end, it was found that with increasing the opening level in the steel shear wall (with reduced cross-section beam), total displacement and plastic strain indicators increased, structural capacity and total energy indicators decreased and the Mises Monson stress index did not change much.

Keywords—Steel plate shear wall with opening, cyclic loading, reduced cross-section beam, finite element method, Abaqus Software.

I. INTRODUCTION

IN general, and especially in high-rise buildings, the building needs tools to reduce the percentage of nonlinear forces caused by earthquakes. Today, in structural and earthquake engineering, new members have been created to dissipate the energy of an earthquake at the time of its occurrence, which provides the possibility of increasing the strength of the structure and improving the safety factor of the building. As a seismic energy dissipation system, the steel shear wall was invented around the world about four decades ago and has been widely used in steel structures. Today, fundamental changes have taken place in the structure of the steel shear wall, including the following:

- Wave the inner screen,
- Use of new types of beams such as reduced cross-section beams in its design and implementation,
- Create openings with different cross sections (circles, squares, rectangles, etc.).

The creation of these changes has increased the efficiency

Masoud Mahdavi is with the Islamic Azad University, Iran, Islamic Republic Of (e-mail: Scientific.Achievements2030@gmail.com).

of the steel shear wall at the time of the earthquake and made it possible to reduce the forces on the building columns [1]. Mu and Young conducted an experimental and numerical study of the seismic behavior of a steel sheet shear wall with an opening. The results showed that by opening, the hardness of the steel shear wall was reduced, but the stress on the members was reduced [2]. Wang et al. evaluated the effect of opening on the seismic performance of steel shear walls. The results showed that the flexibility of the open shear wall increased compared to the non-openable model and the wall strength for energy loss increased [3]. Ashrafi and Gholhaki evaluated the effect of the location of the cavity with a circular cross section on the performance of the steel shear wall [4]. Nasernia and Shokati evaluated the effect of having a hole in the steel shear wall in both laboratory and software models. The results showed that the use of tensile bracing in the wall reduced the effect of plate buckling [5]. Ding et al. evaluated cyclic loading on corrugated steel walls with openings. The results showed that the strength of the steel wall with the opening increased by 14.4% compared to the non-opening model [6].

II. METHODOLOGY

A. Materials

In the modeling of steel shear wall, two types of steel are used, the complete specifications of which are presented in Table I.

TABLE I
SPECIFICATIONS OF STEELS DEFINED IN MODELING OF STEEL SHEAR WALL WITH OPENING

Specifications of Plastic Section	Poisson's Ratio	Modulus of Elasticity (GPa)	Mass per unit Volume (gr/cm^3)	Defined Steel Title
3451	0			
4500	0.08	0.3	7.8	STEEL AL572
4800	0.17			
1651	0			
2500	0.04	0.3	7.8	STEEL YS165
2900	0.1			
3050	0.2			

B. Software Model

The steel plate shear wall with opening is made of beam (horizontal member), column (vertical member), inner plate

and hardener. The general geometry of the shear wall is shown in Fig. 1. The steel shear wall has dimensions of 447×246.6 cm.

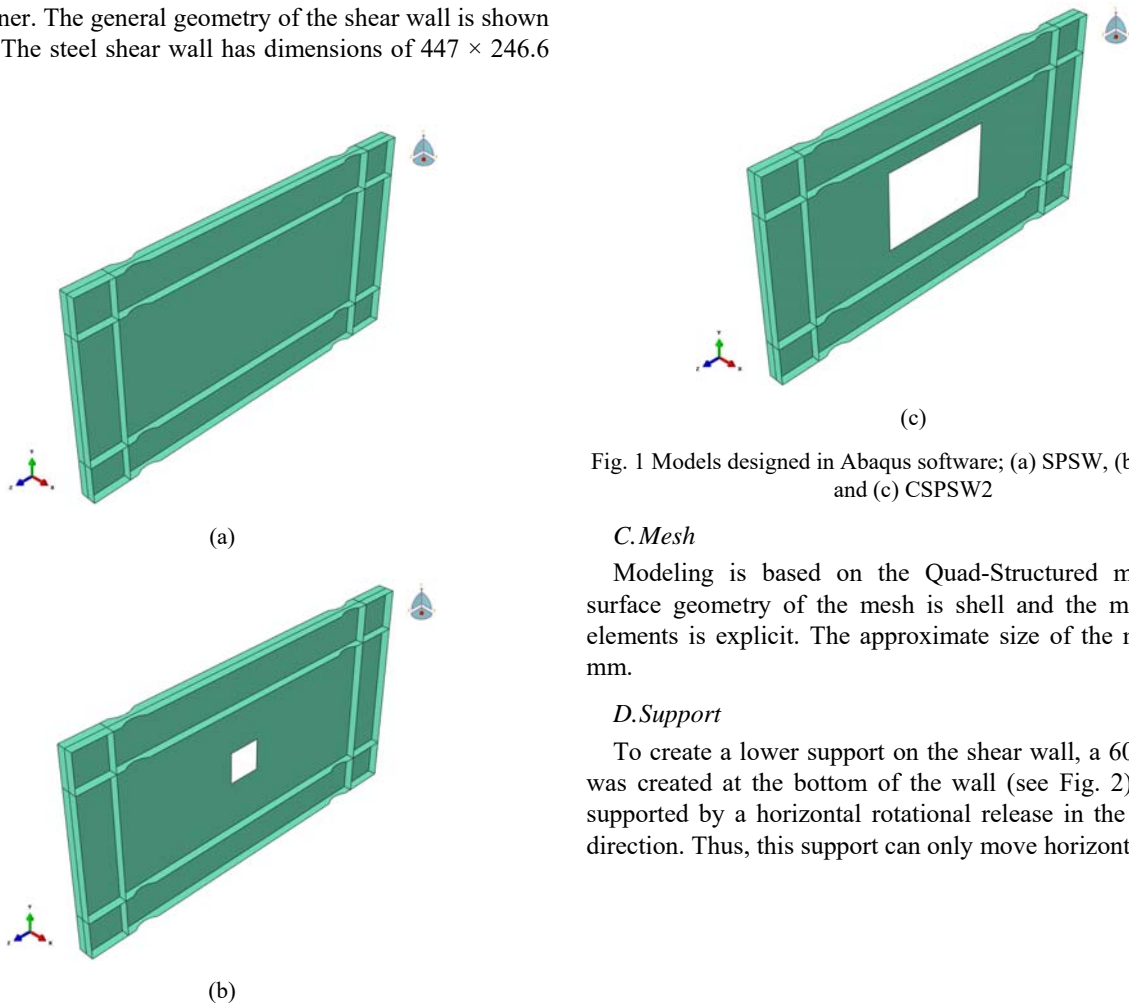

Fig. 1 Models designed in Abaqus software; (a) SPSW, (b) CSPSW1 and (c) CSPSW2

C. Mesh

Modeling is based on the Quad-Structured model. The surface geometry of the mesh is shell and the mesh of the elements is explicit. The approximate size of the mesh is 20 mm.

D. Support

To create a lower support on the shear wall, a 60 cm depth was created at the bottom of the wall (see Fig. 2), which is supported by a horizontal rotational release in the horizontal direction. Thus, this support can only move horizontally.

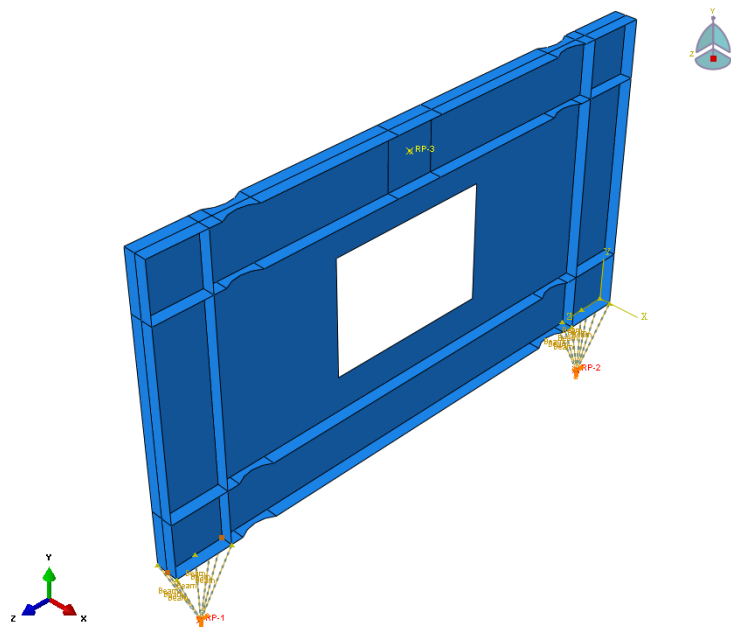

Fig. 2 A lower support to a depth of 60 cm in the steel shear wall with opening

E. Loading

The loading of the open-cut steel shear wall has been

applied to the steel shear wall using a circular load (see Fig. 3) for 96 seconds.

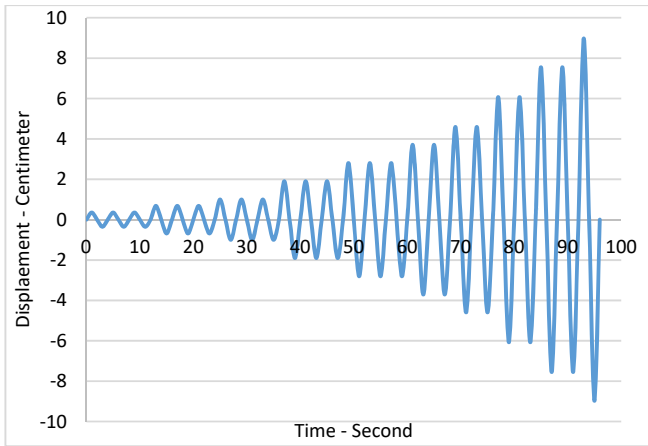
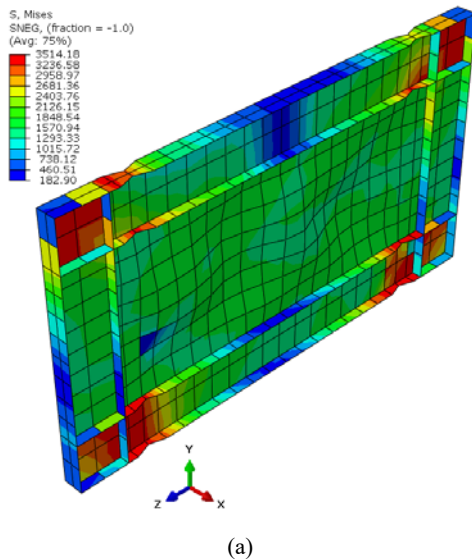

Fig. 3 Cycling load diagram inserted on a steel shear wall in Abaqus software

III. PRESENTING AND ANALYZING THE RESULTS

A. Von Mises Stresses



(a)

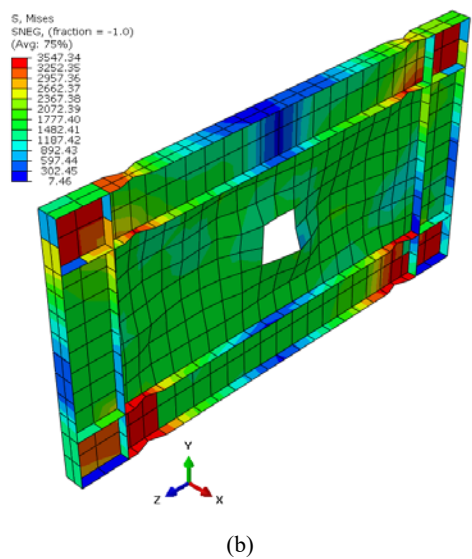

(b)

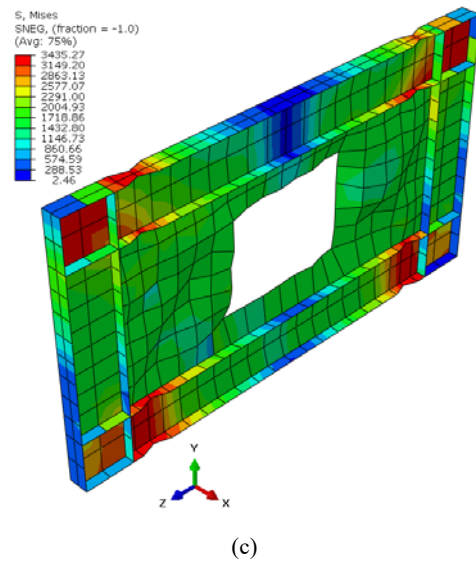

(c)

Fig. 4 Von Mises Stress in models; (a) SPSW, (b) CSPSW1 and (c) CSPSW2 under cyclic load

The results in Fig. 4 showed that the stress index in the CSPSW2 model is less than 3453 megapascals compared to other models. Although the reduction is negligible, the decline indicates that the opening has led to a reduction in the stress of the Masonic phone in addition to the reduction in steel used in the construction of the shear wall and the reduction in the weight of the member.

B. Displacement

The results in Fig. 5 show that as the opening level in the steel wall increases, the amount of displacement is increasing.

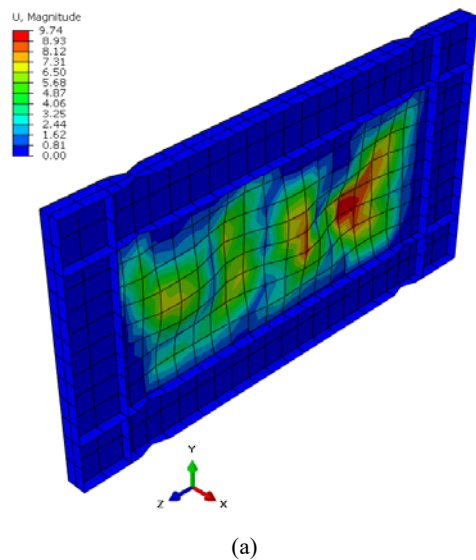

(a)

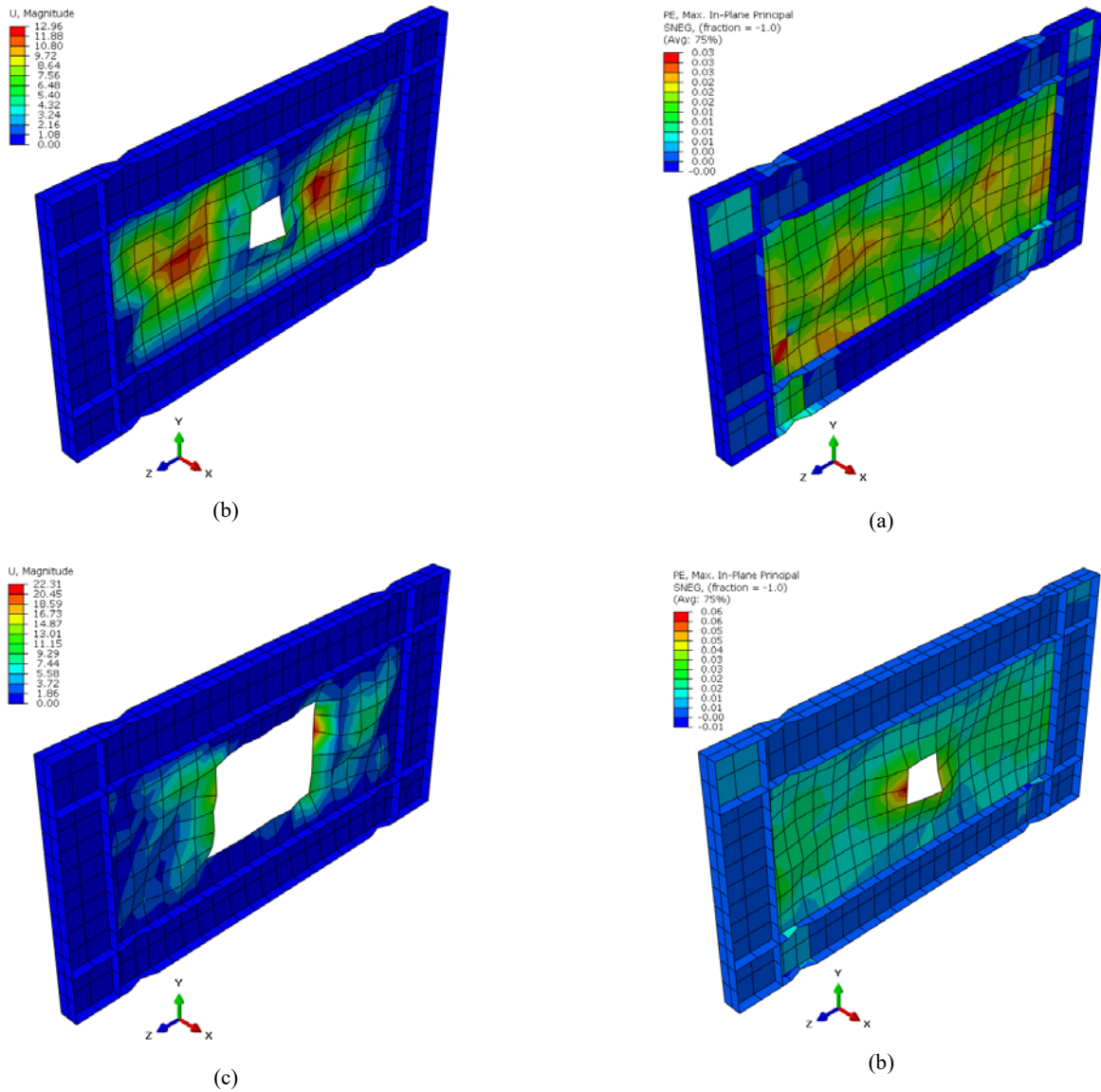

Fig. 5 Displacement in models; (a) SPSW, (b) CSPSW1 and (c) CSPSW2 under cyclic load

C. Plastic Strain

The results in Fig. 6 show that as the opening area increases, the amount of plastic strain on the inner plate of the steel shear wall increases. It was also observed that with increasing the opening level, the joints (the intersection of the beam and the column) were inserted in a smaller amount in the plastic area and therefore were under less force.

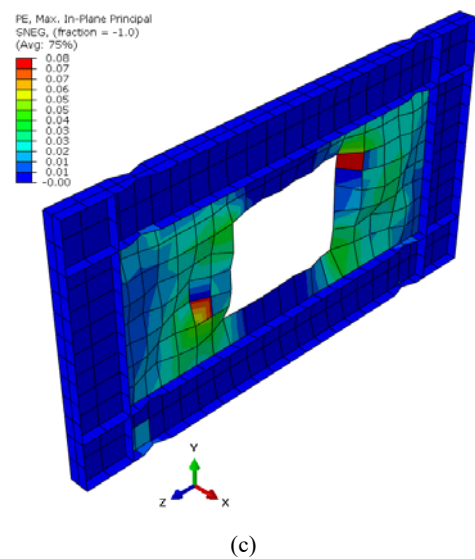

Fig. 6 Plastic strain in models; (a) SPSW, (b) CSPSW1 and (c) CSPSW2 under cyclic load

D. Hysteresis Curve

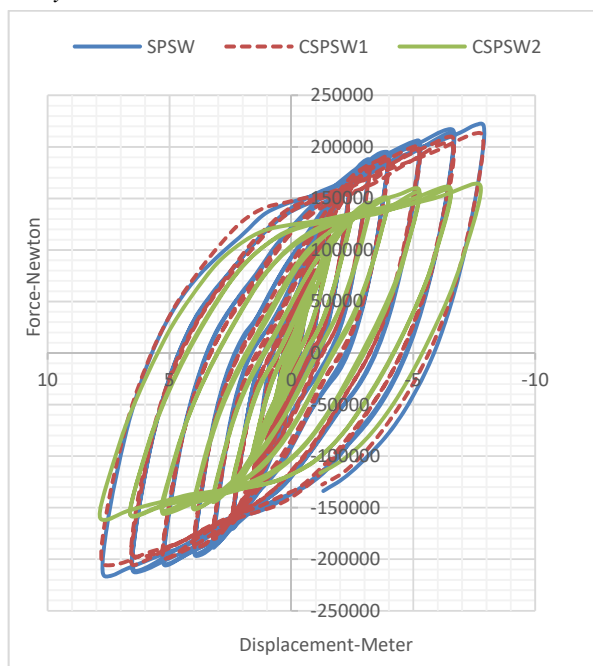

Fig. 7 Hysteresis curve in models; (a) SPSW, (b) CSPSW1 and (c) CSPSW2 under cyclic load

The results in Fig. 7 show that as the opening area increased, the capacity of the steel shear wall (due to the area below the lower graph) decreased.

E. Energy

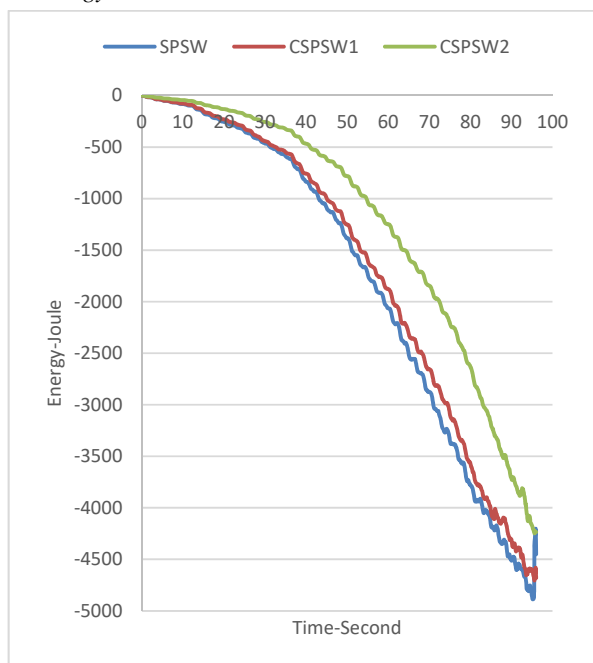

Fig. 8 Total energy Diagram in models; (a) SPSW, (b) CSPSW1 and (c) CSPSW2 under cyclic load

The results in Fig. 8 show that the amount of total energy is decreasing by creating and increasing the opening level in the

steel shear wall. In general, the area under the energy diagram in a non-opening steel shear wall is higher than in open models, which shows the greater power of the SPSW model in energy absorption and depreciation.

IV. CONCLUSION

1. The increase in the opening level in the steel shear wall caused the stress of the Von Mises to have an unpredictable trend. Therefore, there is no obvious relationship between the two indices of open area and the stress of von Mises in the steel shear wall with the reduced cross section.
2. Increasing the opening level in the steel shear wall caused the displacement to increase significantly. Therefore, there is a direct relationship between the two indicators of open area and total displacement in the steel shear wall with reduced cross section.
3. Increasing the opening surface in the steel shear wall caused the numerical value of the plastic strain to increase significantly. Therefore, there is a direct relationship between the two indicators of open area and total displacement in the steel shear wall with reduced cross section.
4. Increasing the opening level in the steel shear wall caused the area below the hysteresis curve (indicating the capacity of the steel shear wall) to decrease. Therefore, there is an inverse relationship between the two indicators of open area and the capacity of the steel shear wall with the reduced cross section.
5. Increasing the opening level in the steel shear wall caused the area below the hysteresis curve (indicating the capacity of the steel shear wall) to decrease. Therefore, there is an inverse relationship between the two indicators of open area and the capacity of the steel shear wall with the reduced cross section.

REFERENCES

- [1] F. Malkeshi, M. Banazadeh, S.A. Serajzadeh, "Micro-finite element damage modeling in steel plate shear walls", *Journal of Constructional Steel Research*, Volume 170, 106074, 2020.
- [2] Z. Mu, Y. Yang, "Experimental and numerical study on seismic behavior of obliquely stiffened steel plate shear walls with openings", *Thin-Walled Structures*, 106457, 2020.
- [3] J. Wang, F. Wang, Q. Shena, B. Yu, "Seismic response evaluation and design of CTSTT shear walls with openings", *Journal of Constructional Steel Research* 153 (2019) 550–566, 2019.
- [4] M. Jalilzadeh Afshari, M. Gholhaki, "Shear strength degradation of steel plate shear walls with optional located opening", *archives of civil and mechanical engineering* 18 (2018), 1547-1561, 2018.
- [5] S. Nassernia, H. Showkati, "Shear strength degradation of steel plate shear walls with optional located opening", *Journal of Constructional Steel Research* 137 (2017) 8–18, 2017.
- [6] Y. Ding, E. F. Deng, L. Zong, X. M. Dai, N. Louc, Y. Chen, "Cyclic tests on corrugated steel plate shear walls with openings in modularized-constructions", *Journal of Constructional Steel Research* 138 (2017) 675–691, 2019.