

# LTE Performance Analysis in the City of Bogota Northern Zone for Two Different Mobile Broadband Operators over Qualipoc

Víctor D. Rodríguez, Edith P. Estupiñán, Juan C. Martínez

**Abstract**—The evolution in mobile broadband technologies has allowed to increase the download rates in users considering the current services. The evaluation of technical parameters at the link level is of vital importance to validate the quality and veracity of the connection, thus avoiding large losses of data, time and productivity. Some of these failures may occur between the eNodeB (Evolved Node B) and the user equipment (UE), so the link between the end device and the base station can be observed. LTE (Long Term Evolution) is considered one of the IP-oriented mobile broadband technologies that work stably for data and VoIP (Voice Over IP) for those devices that have that feature. This research presents a technical analysis of the connection and channeling processes between UE and eNodeB with the TAC (Tracking Area Code) variables, and analysis of performance variables (Throughput, Signal to Interference and Noise Ratio (SINR)). Three measurement scenarios were proposed in the city of Bogotá using QualiPoc, where two operators were evaluated (Operator 1 and Operator 2). Once the data were obtained, an analysis of the variables was performed determining that the data obtained in transmission modes vary depending on the parameters BLER (Block Error Rate), performance and SNR (Signal-to-Noise Ratio). In the case of both operators, differences in transmission modes are detected and this is reflected in the quality of the signal. In addition, due to the fact that both operators work in different frequencies, it can be seen that Operator 1, despite having spectrum in Band 7 (2600 MHz), together with Operator 2, is reassigning to another frequency, a lower band, which is AWS (1700 MHz), but the difference in signal quality with respect to the establishment with data by the provider Operator 2 and the difference found in the transmission modes determined by the eNodeB in Operator 1 is remarkable.

**Keywords**—BLER, LTE, Network, QualiPoc, SNR.

## I. INTRODUCTION

TELECOMUNICATIONS services enable the interconnection of multiple users and facilitate people's daily activities. It is therefore important to achieve the best possible quality to ensure fast and effective communication through improved broadband technologies. The ITU (International Telecommunication Union) defines broadband as the minimum bandwidth capacity required to transfer data by wire or wireless means [1]. Broadband technologies require the analysis of network performance parameters with different

signal quality metrics which evaluate the services present there, such as voice telephony service, data telephony service and messaging. These types of services face daily problems such as interruption or intermittence in the availability of the service, either due to damage to the infrastructure or problems of a logical nature. These problems require being correctly managed for their identification, solution and subsequent monitoring, in order not to affect the performance that is directly related to the quality indicators, which are perceptible to the end user. For this reason, the evaluation of the technical parameters at the data link level is of vital importance to validate their quality and the veracity of the process of starting, maintaining and releasing the connection. The monitoring and analysis of these variables makes it possible to avoid considerable failures that are perceptible to the end user. In LTE there are parameters that allow measuring the quality of service so that operators can improve it and audit it more easily. For example, LTE as an essential part of its process of data transfer between users must monitor the establishment of connection between the eNodeB and the UE, so that the parameters of the link connection between the end device and the base station can be analyzed.

Colombia has several clearly identified operators with infrastructure, some of which generally operate in the 2600 MHz (Band 7) and 1700 MHz (AWS Band) frequency bands for LTE [2]. Entities such as MINTIC (Ministerio TIC) and CRC (Comisión de Regulación de Comunicaciones) have been responsible for monitoring their operation and growth over time [2]. In the research environment, we can highlight studies that allow the analysis of physical link parameters in mobile broadband technologies to identify particular behaviors or perhaps failures for mobile phone systems. In [3], an LTE network was implemented on 3GPP (3rd Generation Partnership Project) standardization using a PicoSDR 2X2 device and amarisoft LTE software in order to measure standardization compliance with QualiPoc. The Wirid-Lab of the Universidad Militar Nueva Granada and the PicoSDR 2X2 equipment are proposed as scenarios for data transmission and through QualiPoc access to the network, carrying out connectivity tests and analyzing operating parameters of the LTE network using SDR.

In [4] the performance analysis of the physical level of LTE technology was developed by means of software SDR. In the stage of recognition of performance parameters, it is possible to observe the parameters BLER, and BER (Bit Error Rate) as a function of the SNR using SISO (Single Input Single

R. O. Victor is with Universidad Militar Nueva Granada, Bogotá, Colombia (phone: 320-989-3946; e-mail: u1401169@unimilitar.edu.co).

E. C. Paola is with Universidad Militar Nueva Granada, Bogotá, Colombia (phone: 301-262-8676; e-mail: edith.estupinan@unimilitar.edu.co).

M. Q. Juan is with Universidad Militar Nueva Granada, Bogotá, Colombia (phone: 311-293-7627; e-mail: juan.martinezq@unimilitar.edu.co).

Output) techniques. Within the tool, different multipath channel models with different bandwidths are simulated. After performing the simulations it was understood that the SNR has great importance in communications because depending on their variations users can be approaching or moving away from the cell, also with the AWGN model (Additive White Gaussian Noise) presents a better performance with the parameters BLER, BER and throughput as a function of SNR, also exceeds the other models for issues of propagation, performance, dispersion that are generated in the frequency channel and time. In a technical analysis of the connection and channeling processes between UE and eNodeB with the different variables was presented, since in the telecommunications sector it is necessary to take into account periodic evaluations of service audits.

In [5] an analysis of the spectrum occupation over the GSM 850 MHz band for a downlink link in Bogotá is presented identifying the different parameters as BSIC (Base Station Identity Code), LAC (Location Area Identity), MNC (Mobile Network Code). The Qualipoc measurement equipment was used. 17 cells were evidenced along the route in the northern area of Bogota where the vast majority makes use of GSMK modulation. Finally, using the spectrogram, the operating band is identified in order to observe the amount of spectral occupation where it is observed that GSM is not the only technology working on that band, thus, the spectral occupation in this area reaches approximately 95.2% of occupation.

In this research, unlike the cases mentioned above, a case study is made in the city of Bogota, north zone, evaluating the performance at data link level of two operators called operator 1 and operator 2. It is highlighted that there are no similar studies for this city in this specific area in this university and that the measurements in LTE are real. Once the data were obtained, an analysis of the variables was performed determining that the transmission modes vary depending on the BLER, performance and SNR parameters. For both operators, differences in transmission modes were detected, which is reflected in the quality of the signal. Due to the fact that both operators work in different frequencies, it can be observed that Operator 2, despite having the spectrum in Band 7 (2600 MHz), together with Operator 1, is reassigning to another frequency, a lower band, which is AWS (1700 MHz). Therefore, Operator 2, regarding the data connection, performs the band selection depending on the transmission modes given in eNodeB; it is worth noting that in Band 7 AWS has 15MHz of bandwidth. It would be interesting to expand this measurement spectrum for areas of Bogota and make a comparison of the parameters and identify behaviors according to the terrain and deployments of mobile broadband service providers. This article is organized initially with a conceptual framework, followed by the definition and implementation of a measurement scenario, the respective data sampling on the segment and finally the identification of the characteristics of the data obtained.

## II. CONCEPTUAL FRAMEWORK

### A. LTE (Long Tern Evolution)

LTE 3GPP (3rd Generation Partnership Project): It is a mobile communications standard developed by the 3GPP agency from HSPA (High-Speed Packet Access). The development of the standard began in 2005 and resulted in specifications for the EPC (Evolved Packet Core) and a new form of E-UTRAN (Evolved Universal Terrestrial Radio Access Network) radio access [6]. LTE Release 8 was developed within IMT 2000 as an evolution of 3G, some call it 3.9G, in September 2009 3GPP introduced LTE-A for IMT-Advanced. In Colombia, Band 7 and the AWS Band operate with LTE [1].

LTE offers a theoretical download speed of 100 Mbps and an upload speed of 50 Mbps with IP-based technology, higher bandwidth of 20MHz for LTE and 100MHz for LTE-A using MIMO (Multiple Input Multiple Output) techniques up to 8x8, packet switching techniques with VoIP and offers latency of up to 10 ms [4]-[6]. Therefore, the ITU standardized LTE-A in November 2010 by the 3GPP with its version 10 and 11, which used OFDMA multiplexing technologies. The deployment of LTE and the increase of stations offer greater coverage and speed. On the other hand, thanks to Shannon's theory, certain parameters can be established to improve the transmission capacity through communication channels affected by Gaussian noise. In LTE, the smaller the cells, the higher is the probability of performing Handover. Also, the higher the speed of the user that is moving, the higher is the probability of performing Handover [4]. The LTE architecture is composed of 3 main areas which are the UE user network, the E-UTRAN access network and the EPC backbone network. Within the access network there is the eNodeB, while within the EPC backbone there is the MME (Mobility Management Entity), SGW (Serving Gateway), PGW (Packet Data Network Gateway), PCRF (Policy and Charging Rules Function), HSS (Home Subscriber Server) and HLR (Home Location Register) [7].

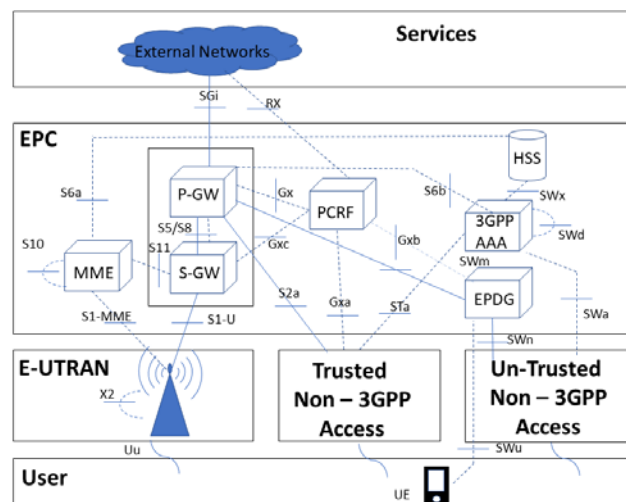

Fig. 1 Basic LTE architecture

Within the architecture, channels are defined that allow communication within the elements that make it up. These are defined as interfaces: Uu, S1-U, S1-C, S1-MME, X2, SGi, S5, S6, S8, S10, S11, among others [8], [9]. Fig. 1 shows this architecture and its interfaces.

From the physical point of view, LTE uses multiple access techniques that allow increasing the transmission rate by taking advantage of the bandwidth available to LTE. These techniques are based on OFDM (Orthogonal Frequency Division Multiplexing), which is a method of transmission of sub-carriers so that each user acquires a sub-carrier to customize the channel in relation to downloading and uploading data. These are divided into OFDMA (Orthogonal Frequency Division Multiplexing Access) and SC-OFDMA (Single Carrier Orthogonal Frequency Division Multiplexing Access) commonly used for uplinks and its main functions are to develop high capacity against multipath propagation and bandwidth flexibility [10].

### III. MIMO STRUCTURES

Any mobile communication network system must have antennas that allow the transmission and reception of information. Depending on the number of antennas, structures are determined, for example MIMO (Multiple Input Multiple Output) where 4 types of structures are highlighted as shown in Fig. 2. Depending also on the type of transmission, terms such as SU-MIMO (Single User MIMO) and MU-MIMO (Multiple User MIMO) appear.

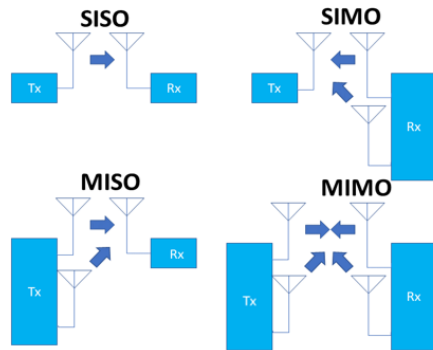

Fig. 2 MIMO antenna structure

MIMO structures are specified in 3GPP release 8 in order to increase the bandwidth. The MIMO array allows determining the capacity of users per cell, coverage, transmission rates. In MIMO the capacity of multipath receptions becomes an advantage that increases the transmission speed [10]. There are two transmission schemes: Closed Loop where the receiver usually feeds back to the transmitter about its received information with connection parameters, in addition, the transmitter generates pre-coding information [10] and Open Loop where the receiver does not feed back to the transmitter, and there is no need for information from the transmitter either [10].

Release 12 of 3GPP establishes 10 transmission modes for downlink [11] which are:

- Single Transmission Antenna (Mode Transmission 1)
- Transmit Diversity (Mode Transmission 2)
- Open Loop Spatial Multiplexing OLSM (Transmission Mode 3)
- Closed Loop Spatial Multiplexing CLSM (Mode Transmission 4)
- MU-MIMO (Mode Transmission 5)
- Closed-loop spatial multiplexing using a transmission layer (Mode Transmission 6)
- Beamforming (Mode Transmission 7)
- Beamforming double layer (Mode Transmission 8)
- 8-layer transmission (Mode Transmission 9)
- Up to 8-layer transmission (Mode Transmission 10)

### IV. LTE CHANNELS

LTE technology channels are divided into 3 types of channels which are the physical, transport and logical channels.

The physical channels carry out the synchronization process from where the information will be sent and it is composed of PDCCH (Physical Downlink Control Channel), PDSCH (Physical Downlink Shared Control), PBCH (Physical Broadcast Channel), PMCH (Physical Multicast Channel), PCFICH (Physical Control Format Indicator Channel) and PHICH (Physical HARQ Indicator Channel) [10]. The logical channels are: PCCH (Paging Control Channel), BCCH (Broadcast Control Channel), CCCH (Common Control Channel), DTCH (Dedicated Traffic Channel, DCCH (Dedicated Control Channel), MTCH (Multicast Traffic Channel) and MCCH (Multicast Control Channel) [10]. The transport channels are: BCH (Broadcast Channel), DL-SCH (Downlink Shared Channel), PCH (Paging Channel) and MCH (Multicast Channel) [10].

### V. QUALIPOC

TABLE I  
 FEATURES OF QUALIPOC SMARTPHONE

	Features
Phone	Samsung Galaxy S5
OS	Android 4.4.2 (SDK:19),
IMEI	352570062773169
CPU	Qualcomm MSM8974AC Snapdragon 801 Quadcore 2.5GHz
GPU	Adreno 330
License	QualiPoc RF, SmartPhone
Network Technology	GSM, HSPA, LTE

Qualipoc Android is a smartphone that provides essential information for detailed analysis of mobile networks. Through Qualipoc different parameters can be measured depending on the technology, for this case LTE [12]. Table I shows the main characteristics. In the QualiPoc device, to perform data acquisition, a "Job" must be performed which is the mode to start data acquisition, in this job, the types of parameters to be recorded will be specified. In this case, the LTE network was specified in the job so that the measurements would only be made on the LTE network, thus, it is ensured that no change of technology is made. Once the data collection is done, the Job

is finished and a CSV file is generated, in order to analyze the obtained data. QualiPoc has about 100 variables that measure the LTE network, parameters such as download speed, upload and download byte transfer, power parameters, signal indicators, etc.

#### A. QualiPoc Variables

- 1) RSRP (Reference Signal Received Power): Power received from the downlink reference signals in the EU in dBm per element of the resource, with the RSRP levels, the signal quality can be determined as shown in Fig. 3 [13].

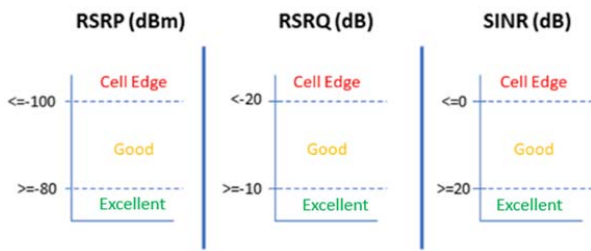

Fig. 3 Power Levels RSRP, RSRQ and SINR [15]

- 2) RSRQ (Reference Signal Received Quality): This parameter indicates the quality of the received reference signal [10].
- 3) SrxLev: It is a level of the UE value against the selection of a cell in dB to determine priority in a cell, this level has to be higher than zero dB, otherwise the UE will have the option to leave the eNB which is associated [14]. Equation (1) allows this level to be determined:
 
$$SRxLev = QRxLevMeas - QRxLevMin \quad (1)$$
- 4) QRxLevMin: This parameter makes it possible to know the minimum threshold that the signal power must not exceed (-128 dBm) [14].
- 5) QrxLevMeas: Value of the Rx level and it is measured with RSRP; it allows us to observe when the minimum value is exceeded [14].
- 6) Bytes Transferred: These parameters allow us to know the amount of information transferred in the channel, there is a variable with the same name, but it acts for upload information [14].
- 7) TM Distribution: This parameter allows to know the type of MIMO technique (1,2,3,4) that is being used through a percentage [10].
- 8) Transmission Mode: Similar to the previous one, it allows knowing the name of the technique (CLSM, OSLM) [10].
- 9) Cp distribution: Cyclic Prefix, there are two types, normal and extended, normal differs from LTE and extended differs from LTE - Advanced. In addition, it also depends on the number of OFDM [15].
- 10) BLER: It is the number of wrong blocks divided by the transmitted block [15].

## VI. SCENARIO

The scenario was selected in an open area in order to analyze the performance parameters in the network and its behavior in areas such as parking lots, sports fields and buildings. A data collection route was proposed within the facilities of the Universidad Militar Nueva Granada Calle 100 as shown in Fig. 4.



Fig. 4 Design of scenery test

The route was defined according to the LTE coverage maps of the area provided by the operators; this area has normally good LTE levels.

#### A. Development

Three test scenarios were defined in order to observe the different parameters and their different behaviours. These measurements were carried out for each operator and for confidential reasons the names of the operators were determined as, Operator 1 and Operator 2. When determining these operators, the providers in Colombia had to be observed and for this case, both work on the same LTE technology. Having said this, these operators work in Band 7 and the AWS Band currently, which are the ones that support LTE services.

TABLE II  
INFORMATION ABOUT SCENERY TEST

Scenario	Activity	Parameters
1	Signal Acquisition	SRxLev, RSRP, RSRQ, TM mode distribution, BLER, TAC, Bytes Transferred (Downlink), Transmission mode, QRXlevMin, SINR1
2	Downlink data	SRxLev, RSRP, RSRQ, TM mode distribution, BLER, TAC, Bytes Transferred (Downlink), Transmission mode, QRXlevMin, SINR1
3	Uplink Data / Downlink Data Acquisition	SRxLev, RSRP, RSRQ, TM mode distribution, BLER, TAC, Bytes Transferred (Downlink), Transmission mode, QRXlevMin, SINR1, Bytes Transferred (UpLink)

In each scenario the same path is assigned using the same parameters, but with three different forms of data acquisition as shown in Table II. For scenario 1, the assigned route was made where signal power levels are determined, i.e., no large-scale traffic is generated and no traffic is loaded, in order to

observe signal power and, in areas where there are fluctuations, also download speed in order to observe what speed is normally used for this type of case. The QualiPoc software defines the RSRP power levels, as shown in Fig. 5, where if the level is less than -100 dBm it will show a red line. In Fig. 5 the route shows some zones where its RSRP value goes down close to -100 dBm for operator 1. It is affected because in the place there are green areas with a variety of trees and buildings of at least 5 floors high. It manages to maintain a unique communication and does not make change of cell or eNB, which is the cause of a limited scenario.

In Fig. 6 the path determined for Operator 2 was made, and it establishes a very good signal quality, although there are areas where interferences might exist, these do not occur and this is partly due to the type of transmission mode used by the eNB.

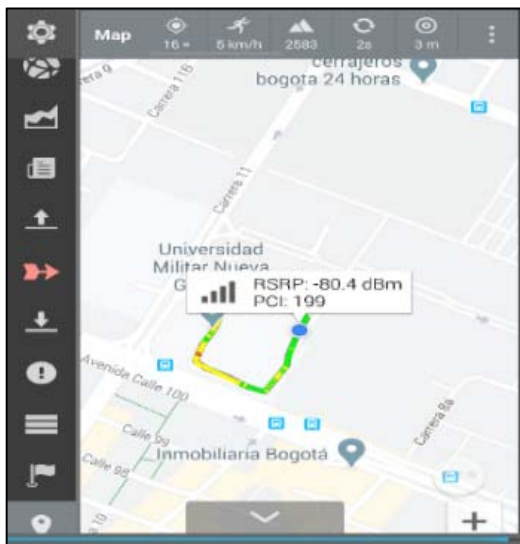

Fig. 5 Operator 1 route in Scenario 1; Source: QualiPoc

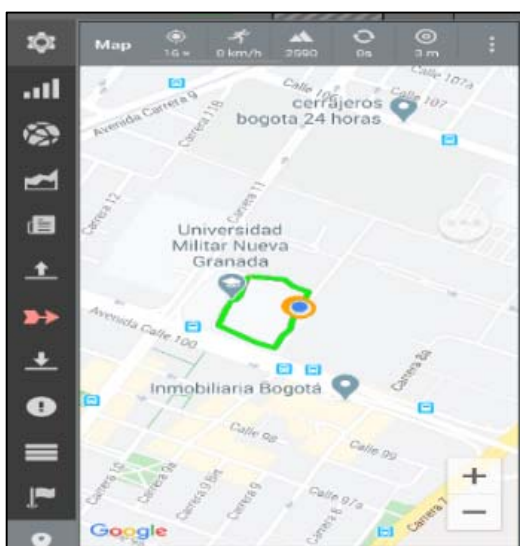

Fig. 6 Operator 2 route in Scenario 1; Source: QualiPoc

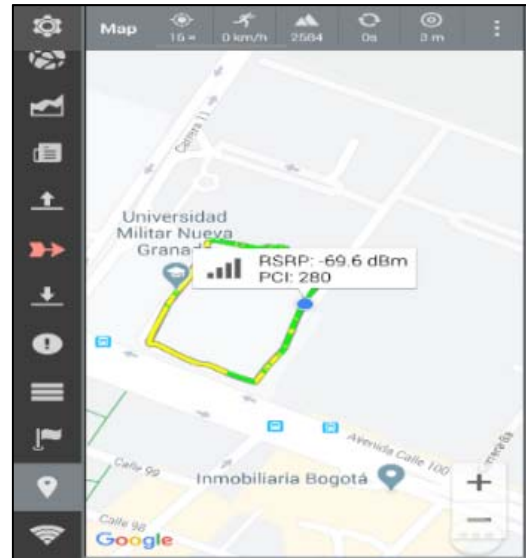

Fig. 7 Operator 1 route in Scenario 2; Source: QualiPoc.

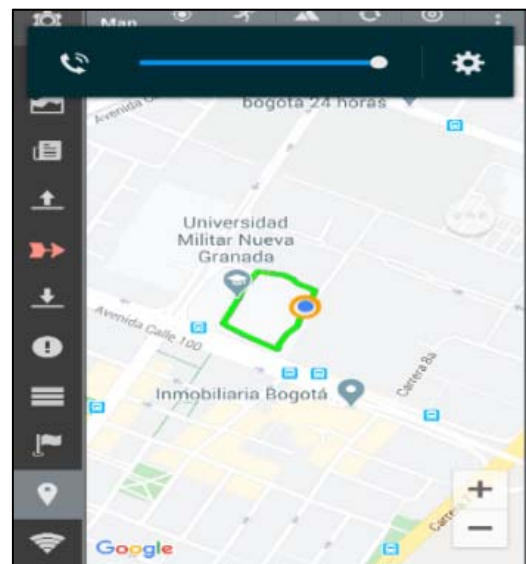

Fig. 8 Operator 2 route in Scenario 2. Source: QualiPoc

For scenario 2, the same path was assigned, but for data acquisition in this scenario a data download was evaluated, which allows us to observe variables of download speed, number of bytes downloaded and power levels. This data download was done by watching a video during the whole tour on the YouTube platform. In Fig. 7 we can see the path for Operator 1 which has power levels similar to Fig. 5; this can be the cause of the problems as a variety of trees and buildings of at least 5 floors high.

Fig. 8 shows the path for Operator 2, in which it still stands out for maintaining a signal quality within the ranges established in Fig. 3, where green means excellent signal.

For scenario 3, the same path was assigned, but for this case, data acquisition is performed simultaneously with data download and data upload, in order to observe data upload parameters as well. Therefore, a video call was made in order

to apply the VoIP service and observe which parameters influenced the quality of the signal or its establishment. This was done through the Skype platform. In Fig. 9 we can see the path for the Operator 1, which in this scenario presented a better signal quality.

Fig. 10 shows the path of Operator 2, which had a fairly good quality establishment; for the 3 scenarios Operator 2 had fairly good coverage.

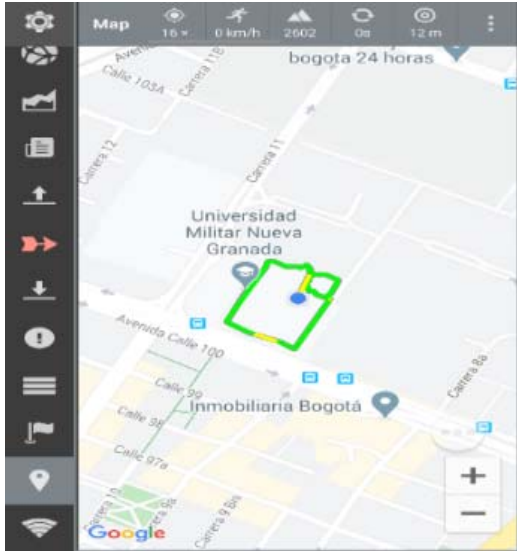

Fig. 9 Operator 1 route in Scenario 3. Source: QualiPoc

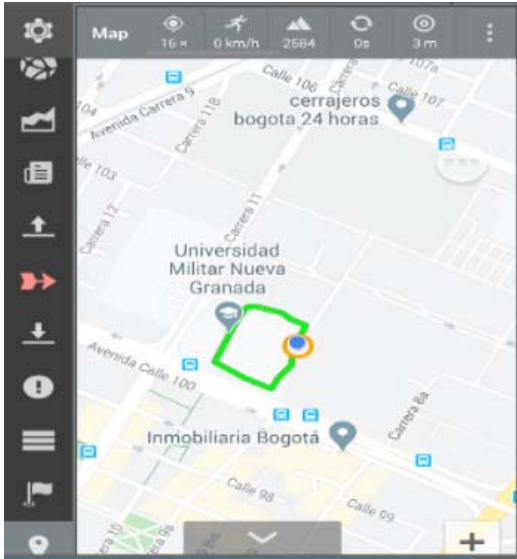

Fig. 10 Operator 2 route in Scenario 3. Source: QualiPoc

## VII. DATA ANALYSIS

In QualiPoc due to the large amount of data being stored per unit of time, it is prone as any system to generate erroneous data. So, QualiPoc reports about 100 variables where 16 were selected to carry out the respective analysis. A CSV file is generated and may present unknown or outliers in the trace and this may affect the results in the statistics, these

outliers were identified when making corresponding graphs of the variables, these outliers were studied to see if they provided useful information about the data, so a cleaning of the data should be carried out. To clean up the respective data set, a basic analysis of the variables that could be most affected was carried out. When the data are cleaned, more precise values are obtained with higher reliability. In order to obtain reliable results, this cleaning was done through RStudio.

The tools used to observe these variables were RStudio and Power BI which, thanks to their ease of data storage, are optimal for obtaining good results. When implementing all the scenarios and their paths, an analysis of the previously chosen variables was performed. Fig. 11 shows the RSRP power parameters for both operators, which are related to what was obtained through the paths. Here it is confirmed that Operator 1 presented a lower signal quality, close to -100 dBm and in some fractions of time being even lower, in contrast, with Operator 2 the signal power is kept in the range of -80 dBm giving thus excellent coverage (see Fig. 3). In Fig. 11 it can be seen that the signal power parameters agree with the ranges set out in Fig. 3, in this way the RSRP values are in a very good reference value, for the case of RSRQ, data are obtained in very good values and finally the values of the SNR parameter SINR1 sometimes showed signal attenuation values.

### 1) Scenario 1

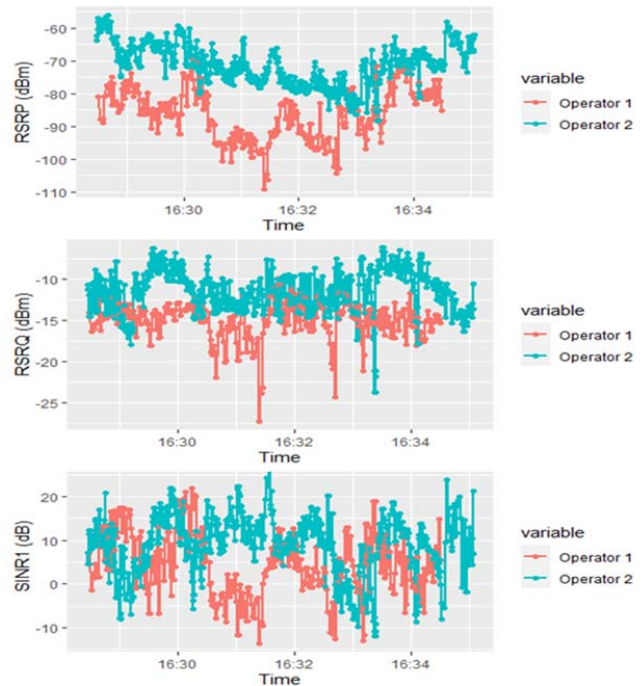

Fig. 11 RSRP, RSRQ and SINR1 measurements scenario 1

Fig. 12 shows the values of the parameter SRxLev which allows us to make the distribution with quartiles, which determine the general distribution of the data from statistics such as the mean, among others. As explained before, the parameter SRxLev must be at least above the value 30 dB to maintain a high priority, in this way we know that the cell

provides good signal parameters, in the quartiles we can see that it maintains a distribution above this value and with some few data that are below for the operator 1.

due to the fact that the scenario presents difficulties in obtaining coverage such as trees and buildings, which is directly affected as shown in the data.

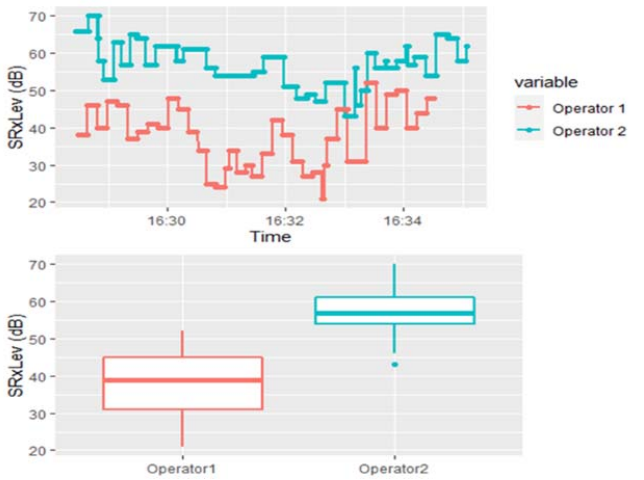

Fig. 12 SRxLev with boxplot measurements scenario 1

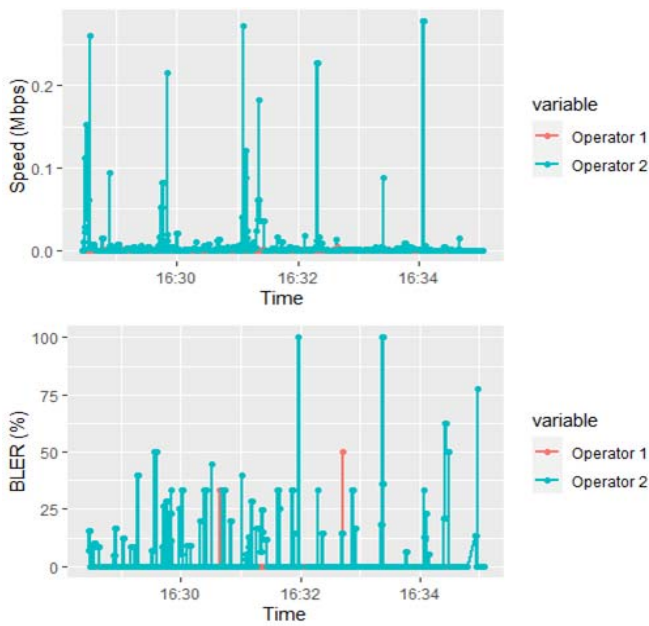

Fig. 13 Speed Downlink and BLER scenario 1

In Fig. 13 one can see the data download, which for this scenario does not present a large data load, so the download speed is very low. With respect to the parameter BLER, this is related to the download speed, because when it increases the probability that a packet is lost is higher, so in Fig. 13 one can see that Operator 2 having a higher download speed, presents more packet loss.

## 2) Scenario 2

Fig. 14 shows the power measurements for scenario 2, which likewise presents acceptable values, in certain fractions of time the signal tends to fluctuate and attenuate, but this is

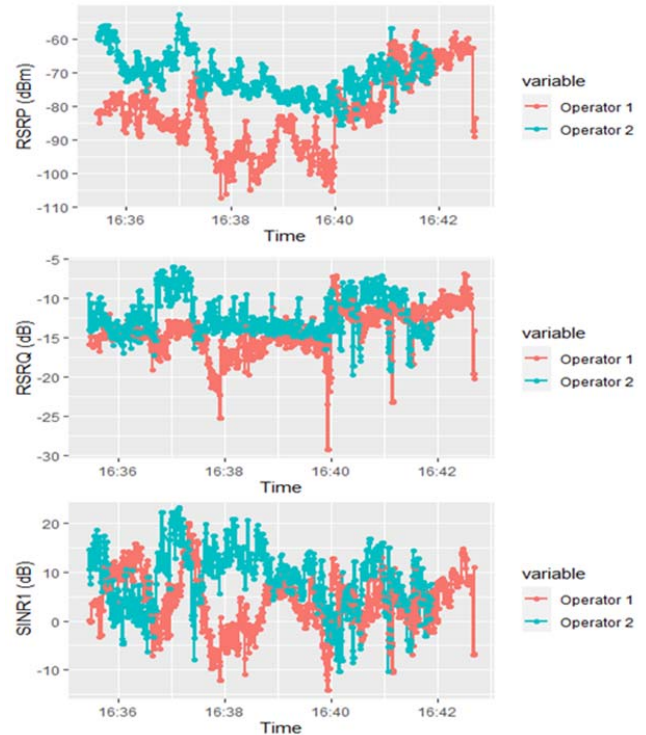

Fig. 14 RSRP, RSRQ and SINR1 measurements scenario 2

In Fig. 15 it can be seen that through the quartile distribution for operator 2 it is maintained in a good signal, while operator 1 maintains a distribution with priority for the low SRxLev parameters, below the value of 30 dB established, which can be seen in Fig. 15 that operator 1 presented a greater signal deficit.

In Fig. 16 one can see that the download speed increases significantly in this scenario and it is due to the continuous download of data, one can see that, as the download speed increases, the probability of packet loss increases.

## 3) Scenario 3

In Fig. 17 one can see that the power parameters for the last scenario, which, for this case presents similar power values for both operators but they are very good power values, meaning that the signal had very little attenuation in the path.

In Fig 18 one can see the distribution of the SRxLev parameters for both operators, in which operator 2 is far above operator 1 offering greater coverage and signal quality. Particularly in this case the priorities are constant and this is due to weather conditions or number of users per cell, the priority for both operators is very good, so it is directly related to the quality of the cell signal.

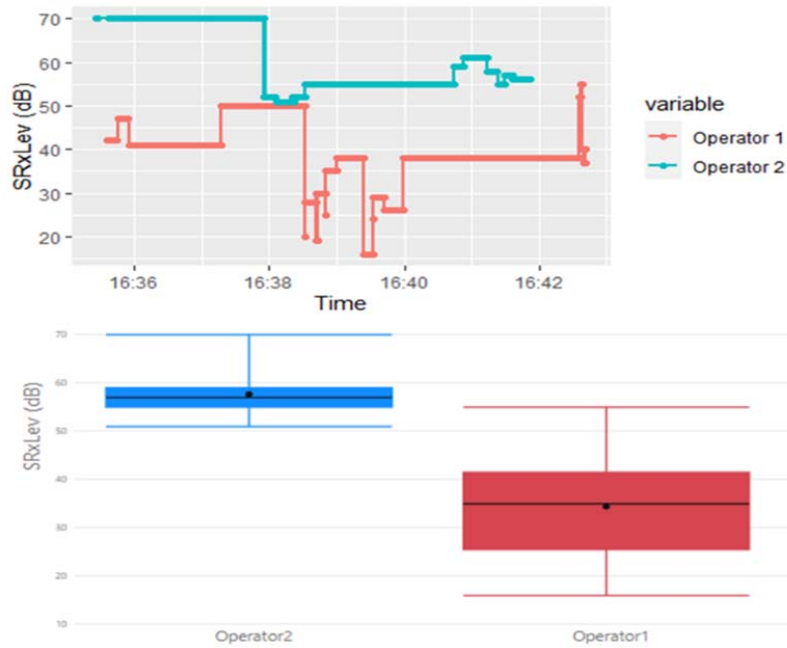

Fig. 15 SRxLev with boxplot scenario 2

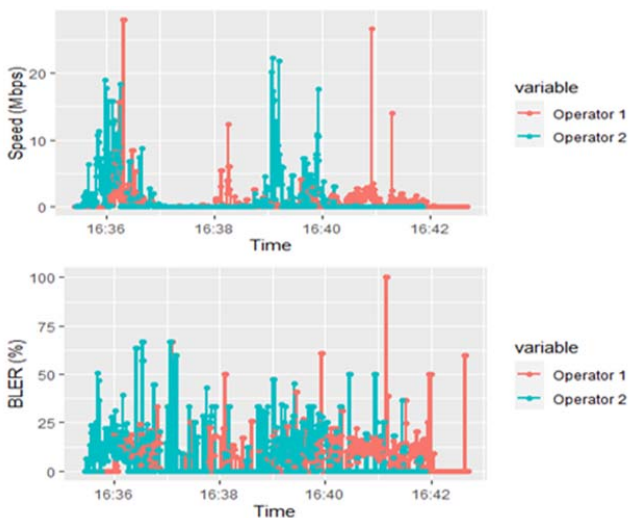

Fig. 16 Speed Downlink and BLER measurement scenario 2

For this scenario, since it is a video call, certain parameters are considered since the analysis must be counted for the uplink channel. As shown in Fig. 19, the uplink and downlink speeds are kept in high ranges, around 5 Mbps and 10 Mbps, which is the average download speed offered by the operators in the LTE service in the city of Bogotá. As mentioned above, this parameter is directly affected by the download speed, so the number of packets can increase the probability of being lost, see Fig. 20.

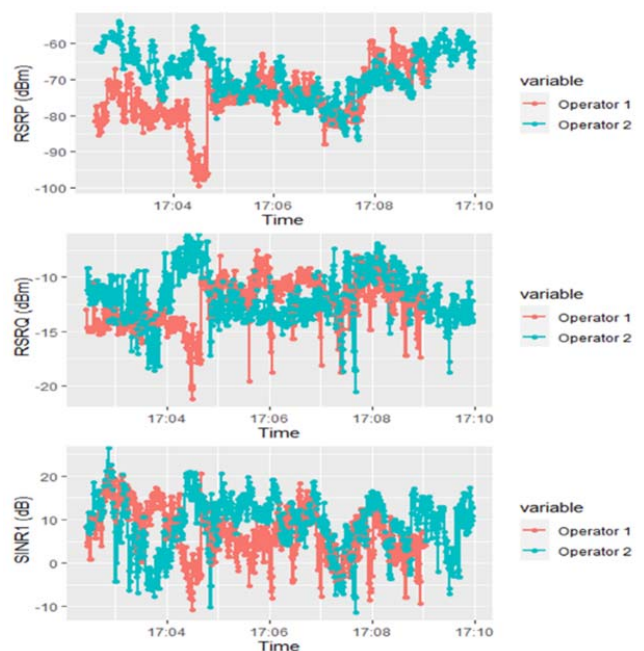

Fig. 17 RSRP, RSRQ, SINR1 measurement scenario 3

## VIII. CONCLUSION

It was determined that operator 2, using a lower frequency, offers a higher signal quality, where the power remained in the range of -80 dBm. Operator 1 with higher frequency and higher bandwidth offers more download speed, about 30 Mbps, while the operator 2 did not exceed 20 Mbps.

It was observed that the transmission modes affect directly the signal quality, depending on the MIMO techniques, the operator 2 performs different MIMO techniques during the different paths, it helps to have good coverage and signal



quality, while the operator 1 maintains only one transmission technique and the signal quality is affected.

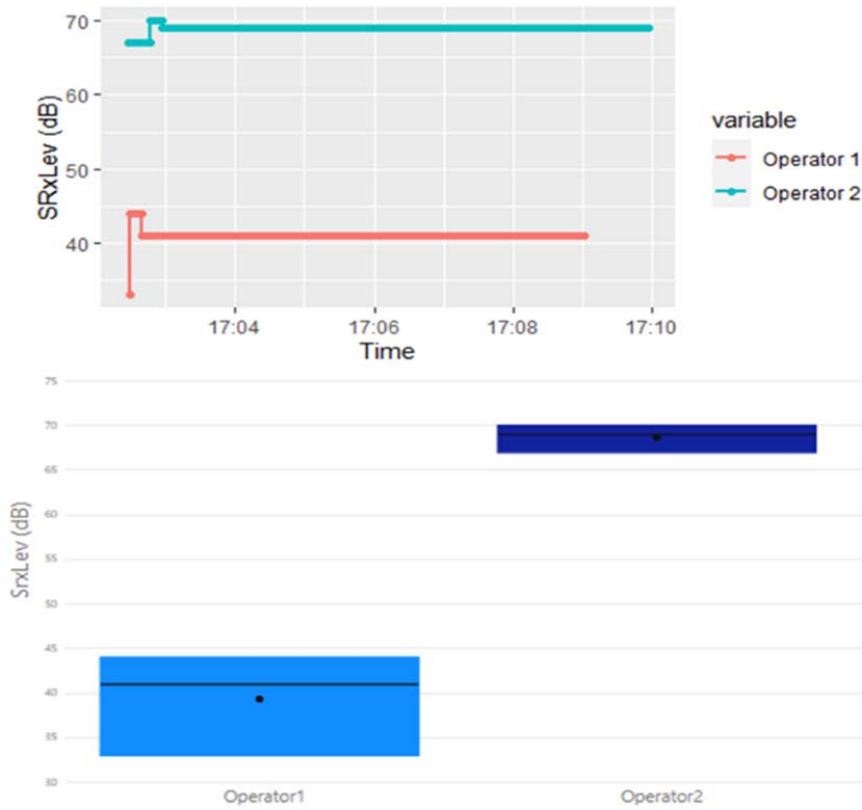

Fig. 18 SRxLev with bloxplot measurements scenario 3

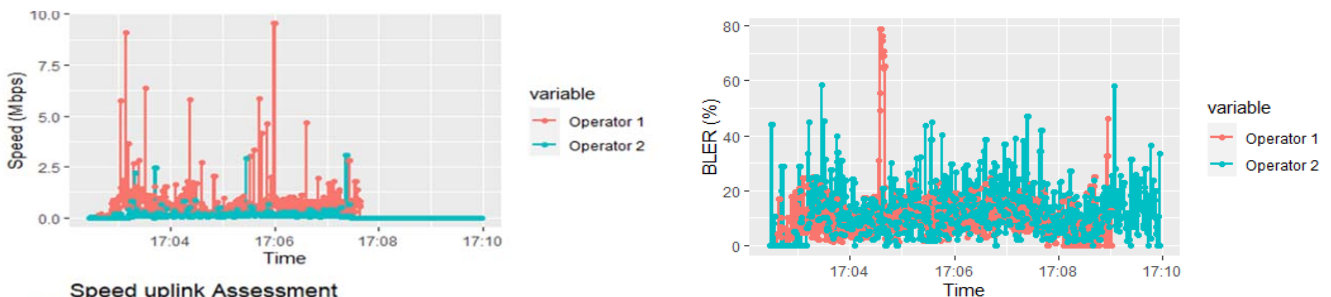

Fig. 20 BLER measurement scenario 3

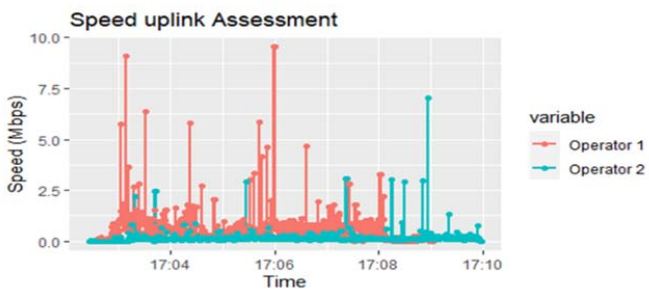

Fig. 19 Speed Downlink and Uplink scenario 3

It was observed that although both operators presented signal quality and coverage attenuations, particularly operator 1 presented more signal deficit compared to operator 2, they also presented acceptable signal levels, despite their different coverage and area difficulties. Operator 2 had better results than operator 1 regarding signal quality.

#### ACKNOWLEDGMENT

This work was developed within the GISSIC research group as a product derived from the Maxwell research seedbed funded by Vicerrectoría de Investigaciones de la Universidad Militar Nueva Granada.

#### REFERENCES

- [1] M. K. S. Keith, "Birth of Broadband - Frequently Asked Questions," Apr. 04, 2011. <https://www.itu.int/osg/spu/publications/birthofbroadband/faq.html>.
- [2] MinTIC Colombia, "Boletín Trimestral de las TIC," Boletín Trimest. las TIC, pp. 1-50, 2020, (Online). Available: [https://colombiatic.mintic.gov.co/679/articles-125648\\_archivo\\_pdf.pdf](https://colombiatic.mintic.gov.co/679/articles-125648_archivo_pdf.pdf)
- [3] R. A. Tatiana, "Evaluación de Características Técnicas del Equipo PICOSDR 2X2E para la Implementación de Tecnología LTE, Usando el Software Amarisoft," Repos. UMNG, pp. 1-85, 2017.

- [4] F. Bernardo, F. Casadevall, and O. Sallent, LTE: Nuevas tendencias en comunicaciones móviles. 2010.
- [5] E. P. E. C. Juan Carlos Martínez Quintero, José de Jesús Rugeles Uribe, "Spectrum occupancy analysis over band GSM 850 on Bogotá," *Rev. Visión electrónica*, vol. 12, no. 1, pp. 5–13, 2018, doi: 10.14483/22484728.14801.
- [6] 3GPP, "Rel-08\_description\_20140924." 2014, (Online). Available: [http://www.3gpp.org/ftp/Information/WORK\\_PLAN/Description\\_Releases/](http://www.3gpp.org/ftp/Information/WORK_PLAN/Description_Releases/).
- [7] 3GPP, "23002-310." (Online). Available: [https://www.3gpp.org/ftp/Specs/archive/23\\_series/23.002/](https://www.3gpp.org/ftp/Specs/archive/23_series/23.002/).
- [8] 3GPP, "Draft-36401v000." (Online). Available: [https://www.3gpp.org/ftp/Specs/archive/36\\_series/36.401/](https://www.3gpp.org/ftp/Specs/archive/36_series/36.401/).
- [9] 3GPP, "R2-062036 E-UTRAN Stage 2 v002." (Online). Available: [https://www.3gpp.org/ftp/Specs/archive/36\\_series/36.300/](https://www.3gpp.org/ftp/Specs/archive/36_series/36.300/).
- [10] G. González, D. Prado, F. Marante, and A. Ledesma, "Análisis de las prestaciones de los sistemas LTE y LTE-Advanceda partir de procesos de simulación," *Ingeniare*, vol. 25, no. 3, pp. 364–375, 2017, doi: 10.4067/S0718-33052017000300364.
- [11] 3GPP, "RP-151570\_Rel-12\_description\_20150909." 2015, (Online). Available: [https://www.3gpp.org/ftp/Information/WORK\\_PLAN/Description\\_Releases/](https://www.3gpp.org/ftp/Information/WORK_PLAN/Description_Releases/).
- [12] "QualiPoc Android | Rohde & Schwarz." [https://www.rohde-schwarz.com/es/producto/qualipoc\\_android-pagina-de-inicio-producto\\_63493-55430.html](https://www.rohde-schwarz.com/es/producto/qualipoc_android-pagina-de-inicio-producto_63493-55430.html) (accessed Apr. 25, 2020).
- [13] Press Office, "RSRQ to SINR Relation - arimas," 2016. <https://arimas.com/164-rsrq-to-sinr/> (accessed Apr. 25, 2020).
- [14] Parjna Poojari, "Multi Carrier Cell Re-selection in LTE - Techplayon," 2019. <http://www.techplayon.com/multi-carrier-cell-re-selection-in-lte/> (accessed Apr. 25, 2020).
- [15] M. Kawser, "Downlink SNR to CQI Mapping for Different Multiple Antenna Techniques in LTE," *Int. J. Inf. Electron. Eng.*, vol. 2, no. 5, pp. 757–760, 2012, doi: 10.7763/ijiee.2012.v2.201.