

# Mechanical Qualification Test Campaign on the Demise Observation Capsule

B. Tiseo, V. Quaranta, G. Bruno, R. Gardi, T. Watts, S. Dussy

**Abstract**—This paper describes the qualification test campaign performed on the Demise Observation Capsule DOC-EQM as part of the Future Launch Preparatory Program FLPP3. The mechanical environment experienced during launch ascent and separation phase was first identified and then replicated in terms of sine, random and shock vibration. The loads identification is derived by selecting the worst possible case. Vibration and shock qualification test performed at CIRA Space Qualification laboratory is herein described. Mechanical fixtures' design and validation, carried out by means of FEM, is also addressed due to its fundamental role in the vibrational test campaign. The Demise Observation Capsule (DOC) successfully passed the qualification test campaign. Functional test and resonance search have not been point any fault and damages of the capsule.

**Keywords**—Capsule, demise, DOC, launch environment, Re-Entry, qualification.

## I. INTRODUCTION

THE DOC project is part of the Future Launch Preparatory Program (FLPP), aimed at the study of future generation space launchers. The particular DOC (Demise Observation Capsule), Fig. 1, aims to realize a flight prototype of a re-entry capsule that works as a black box for the space launchers' stages. The capsule, remaining in solidarity with the carrier, performs data acquisition, then separates and transmits the received data to the ground. After the hypersonic part of the flight, the capsule will transmit the data through the global satellite network IRIDIUM.

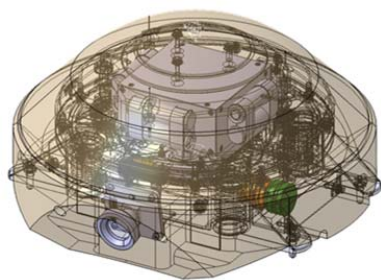

Fig. 1 DOC

The analysis of the data measured during atmospheric re-entry phase will help in accurately predicting break-up

Tiseo B., Quaranta V., Bruno G., and Gardi R. are with the Italian Aerospace Research Center, Capua, 81041 Italy (e-mail: b.tiseo@cira.it, v.quaranta@cira.it, g.bruno@cira.it, r.gardi@cira.it).

T. Watts is with S[&]T - Science & Technology Corporation, 2616 LR, Delft, The Netherlands (e-mail: trevor.watts@stcorp.nl).

S. Dussy is with ESA-European Space Agency, Paris, 75012 France (e-mail: stephne.dussy@esa.int).

altitudes, debris trajectories and ground impact footprint. These analyses are therefore critical for not only mission success, but also more importantly for improving public safety aspects of such re-entry scenarios [1].

The DOC is developed and qualified for the European Space Agency (ESA). S[&]T leads the European consortium of industry partners and research centre, including CIRA, in close cooperation with the ESA [1]. CIRA as part of the European consortium, first designed and manufactured the capsule structures, mechanisms and TPS by selecting a rapid prototyping system for the EQM, then led to the qualification tests campaign aimed at demonstrating the survival of the Capsule.

The structural parts of the Proto-Flight-Model (PFM) are manufactured in Titanium alloy, by using the Electron Beam Melting (EBM) capabilities owned by CIRA. A highly complex EBM system, based on Additive Layer Manufacturing (ALM) allowed producing the metallic part to be used for mechanical tests of the payload and interfaces, while the resin parts have been 3D printed in order to create an effective mock-up, suitable for assessing integration procedures and tests. In addition to the space qualification, CIRA is responsible for aerodynamics, thermo-structural design and construction of complex thermal mechanisms and protections of the system [2]. CIRA's commitment to the DOC project continued with the vibration and shock testing campaign, aimed at demonstrating the survival of the Capsule when it is subjected to loads exerted during the launch and mission.

The operative environment was firstly defined by taking into account the uncertainty about the position of the DOC at the time of the qualification phase, it was assumed to place it on the AVUM module of the VEGA launcher. Furthermore, as the vibration levels depend from the position on AVUM, to be conservative, the worst case was selected [3]. Then the mechanical fixtures design was performed. Fixture allows to mount specific test specimen onto a vibration table and transmits forces produced by shaker to the test article. Fixture should be designed to have the least mass possible (weight limits on shaker), to be as stiff as possible (to avoid unnecessary vibrations), without natural frequency within test range (in order not to amplify vibration loads).

## II. MISSION PROFILE AND ENVIRONMENTAL LOADS

The DOC is a small capsule attached on a Launcher Upper Stage. As the mission payloads are released, DOC remains with the rocket stage and separates as re-entry begins [1].

When in orbit, during the first part of the re-entry, the

capsule remains attached to the stage and will only separate when the disintegration of the same starts.

As the capsule descends toward the Earth, it will continue making measurements and broadcast them back to the Earth. The capsule was constructed such that it will be able to withstand the hostile conditions of the launch, the re-entry and close-by disintegration of the launcher [1].

One of the challenges in space qualification tests is to define the operational environment such that the system is tested to the limits of a mission without requiring expensive overdesign. During launch and mission, space equipment is exposed to a variety of mechanical, thermal, and electromagnetic loads.

The launch vibrations originate from rocket engine ignition, atmospheric drag, stage separations, while in orbit vibrations originate from trajectory corrections using on board engines. Rocket launches generate a considerable quantity of acoustic energy, when gases ejected from engine nozzles, reflexed from the ground, create turbulence inducing vibration of the rocket structure. Typical noise levels are around 170-200 dB, and are concentrated in the low to mid frequency range. The acoustic energy in terms of external pressure field causes a vibration response of the structure which is transmitted to the payload in form of random vibration [4]. Random vibration input occurs over a broad frequency range, from about 10 Hz up to 2000 Hz. Finally, sine vibrations, due to excitation of launcher first longitudinal resonance modes due to rocket engine pressure oscillation and Pogo effect [5].

Mechanical shock loads are instead mainly caused by the actuation of pyrotechnic devices as release mechanisms for stage and satellite separation, deployable mechanisms for solar arrays [5]. Pyrotechnic shock also occurs in flight during engine firing for orbit correction. Typically shock loads are represented by Shock Response Spectrum.

To ensure that the DOC was delivered in line with the agreed requirements, an effective verification strategy was required. According to the DOC validation test plan [6], a proto-flight approach is applied by taking into account the best model approach for the project time frame and budget. The DOC design phase was verified and validated by using an EQM. The qualification test campaign started with the identification of expected operative environment. An envelope of possible load conditions was considered, thus preserving the possibility of using different launching platforms [7]-[10]. The mechanical tests consisted of:

- random and sinusoidal vibration test;
- modal survey for resonance search, performed before and after vibration test, in order to detect possible structural fault highlighted by resonance frequency peaks changing or amplitude variation;
- shock test.

The experimental verification of mechanical fixture design was performed before qualification test campaign.

### III. TEXT FIXTURE DESIGN AND VALIDATION

The mechanical fixture design requirements are following:

- Fixture shall interface the EQM in the same way the HVI

interface the capsule DOC.

- Fixture shall be interfaced to the vibration table and to the Shock table.
- Fixture shall permit tests along three axes X, Y and Z
- Fixture shall be suitable for testing in the 20-2000 Hz range.

A numerical modal analysis was carried out by means of FE software (ANSYS) by assuming  $1.0e-3$  damping coefficient and considering clamped conditions at the base of the fixture.

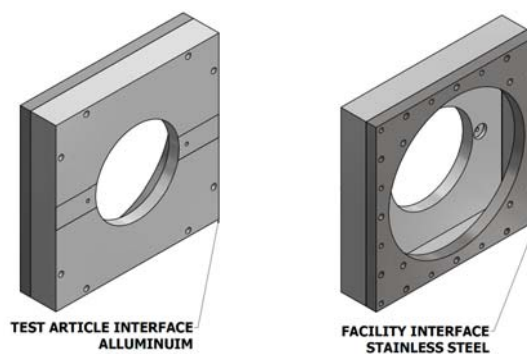

Fig. 2 Mechanical Fixture 3D Model

Numerical analyses showed that the first modal frequency is higher than 2000 Hz, and then no additional analyses were needed.

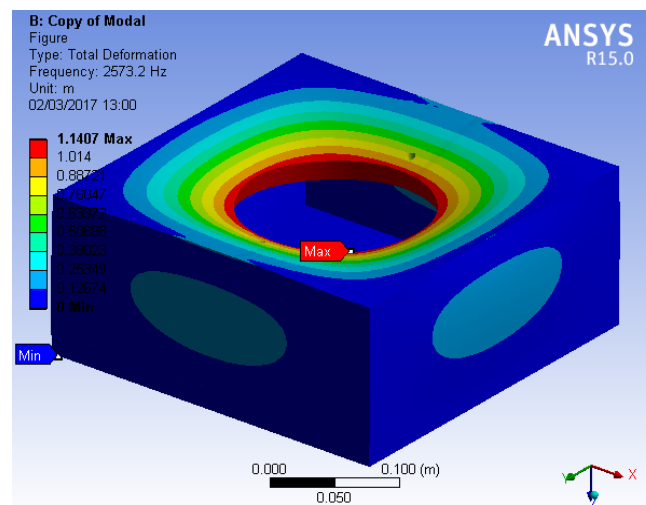

Fig. 3 Fixture FEM model

A fixture resonances search was performed in order to verify the achieved results by the numerical simulation. In the frequency range of interest (0-2000 Hz), no significant transmissibility values (higher than 2) were detected, as shown in Fig. 5. Resonance search was executed by using the shaker TIRA S597LS-440 controlled by the Vibration Research Control Acquisition System, in turn, managed by the Vibration View software.

### IV. SPACE QUALIFICATION TEST CAMPAIGN

The DOC underwent an extensive qualification test

campaign to demonstrate that the EQM was able to survive the mechanical loads experienced throughout launch and deployment with undefined launcher. An envelope of possible load conditions was considered, thus preserving the possibility of using different launching platforms [8]-[10]. The mechanical test campaign comprises:

- ❖ Vibration Test:
  - High level Sine Sweep (HLSS) (X,Y,Z)
  - Random Vibration (RV) Test (X,Y,Z)
- ❖ Shock Test (X, Y, Z).

Furthermore, Low Level Resonance Search (LLRS) was performed before and after vibration test, in order to detect structural fault highlighted by resonance frequency peak changing or amplitude variation.

All vibrational tests were executed by using the shaker TIRA S597LS-440, controlled by the Vibration Research Control Acquisition System, in turn managed by the Vibration View software. For in plane excitation, the shaker was coupled

with the slip table, see Fig. 6, while for out of plane excitation, it was coupled with a head expander as shown in Fig. 7.

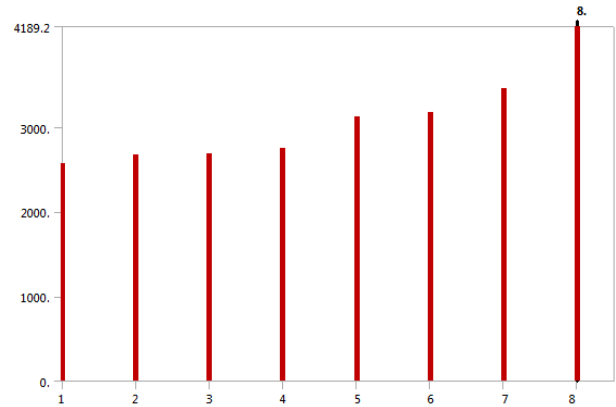

Fig. 4 Mechanical Fixture FE Modal Analysis

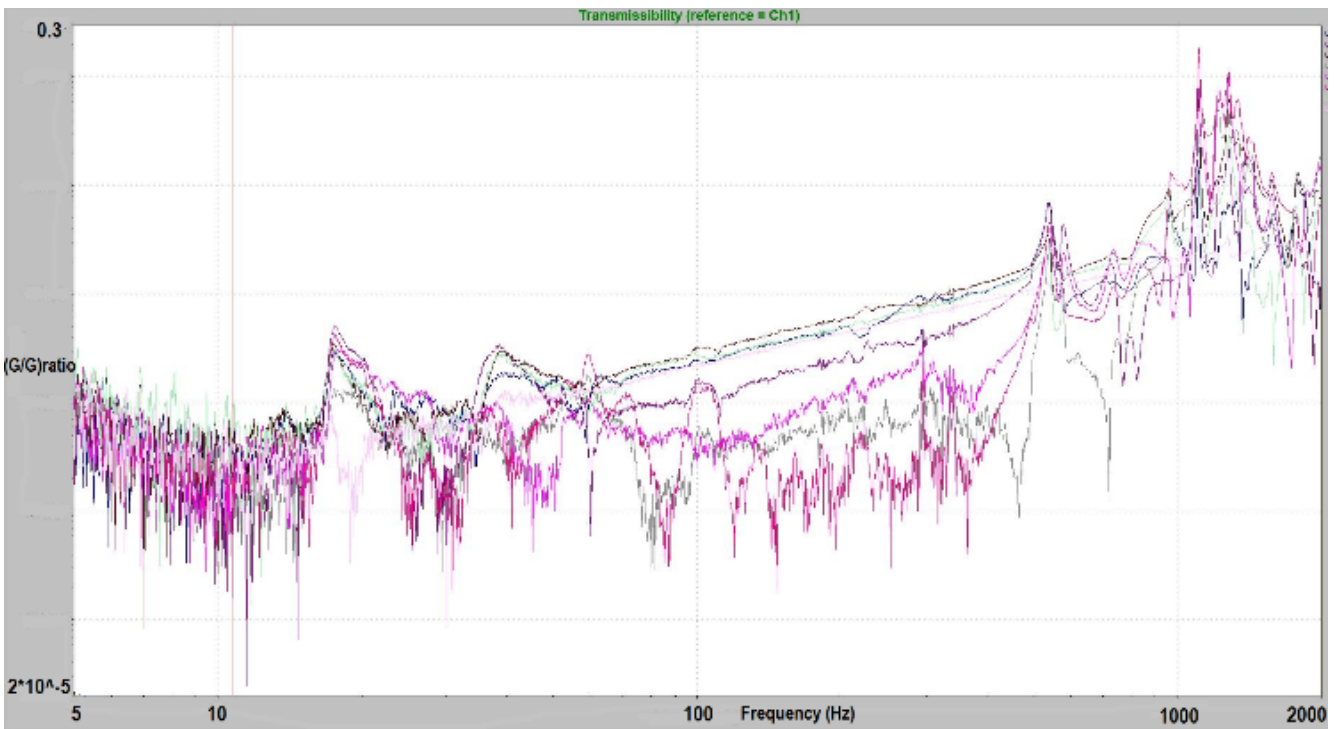

Fig. 5 Fixture Experimental Resonance Search



Fig. 6 DOC installed on the slip table for In Plane Test

For in plane configuration, two tri-axial transducers were used as measurement accelerometers, respectively positioned on the avionic and on the back plate of the capsule, Fig. 8.

One tri-axial transducer was used as control accelerometer installed respectively on the slip table, for in plane test, and on the shaker armature, for out of plane test.

The HLSS tests were performed at test levels reported in Fig. 10, while RV tests were executed according to values reported in Fig. 12. Applied loads are illustrated on Fig. 10 and Fig. 12.



Fig. 7 DOC installed on the TIRA shaker for Out of Plane Test

Shock test has been performed by using a mechanical facility, designed by CIRA. The facility is made of a frame of modular aluminum profiles supporting a resonant plate and hosting a hammer with its arm. The facility is able to simulate mechanical shock impact with a very high frequency content (up to 10 KHz) and high amplitude (up to 10000 g). The input SRS can be tuned by varying different parameters as hammer impact velocity and mass, plate thickness, test item position. A double configuration is possible in order to generate in plane and out of plane excitations, to meet test specifications.

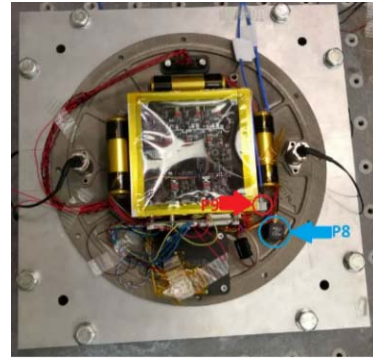

Fig. 8 DOC- P8-P9 Measurements Accelerometers location

Frequency Range (Hz)	Level [0-peak]	Sweep rate
5-16	7.5 mm	1/3 oct/min
16-35	7.5 g	
35-60	7.5 g	
60-70	16.8 g	2 oct/min
70-200	16.8 g	
200-2000	7.5 g	

Fig. 9 DOC EQM HLSS test levels



Fig. 10 DOC EQM HLSS Measured levels –Acceleration vs Frequency

Frequency Range (Hz)	Density (g <sup>2</sup> /Hz)	RMS value (g)	Duration
30-150	+6dB/Oct	9.855	2 min/axis
150-700	0.0727		
700-2000	-3sB/Oct		

Fig. 11 DOC RV Test levels

For X, Y excitation the facility was set up in in-plane configuration, while, for Z excitation, it was set up in out of plane configuration. Shock test levels applied are reported in Fig. 13.

After the tuning phase aimed at identifying the best parameters' combination (hammer impact velocity and mass, plate thickness, test item position) allowing the requested SRS achievement, the shock test has been executed, see Fig. 14,

Fig. 15.

## V. CONCLUSION

Qualification test campaign was performed on DOC-EQM as part of the FLPP3. The experimental procedure was described together with mechanical fixture design and analysis.

The test campaign was successfully completed and the capsule survived to shock and vibration load applied. Functional tests were performed before and after each test. The onboard computer was powered with the onboard power system, simulating flight conditions, sensors have been acquired and memory unit has been written and verified by means of external support computer. Any fault or damages has not been highlighted. Resonance search before and after test did not point out any significant resonance peak' frequency shift or amplitude variations.

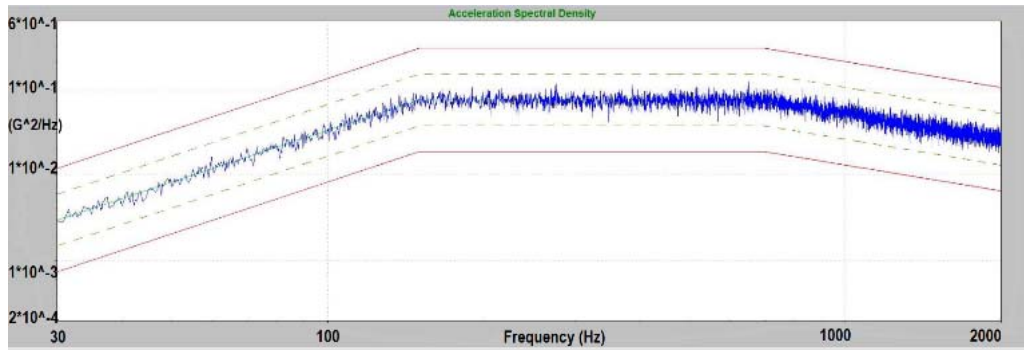

Fig. 12 DOC EQM Power Spectral Density –Measured Levels

Frequency Range (Hz)	SRS levels (g)
100	60
600	4000
2000	10000
5000	10000
10000	10000

Fig. 13 Shock Qualification Test Levels

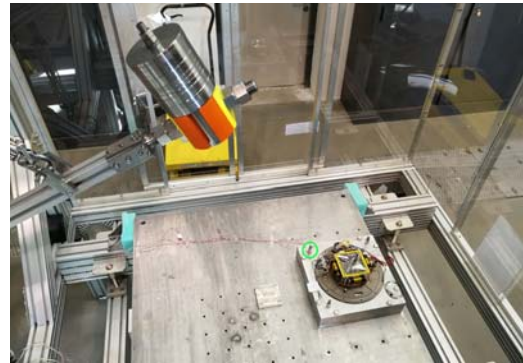

Fig. 14 DOC Shock test set up –Z direction-Measuring Accelerometer

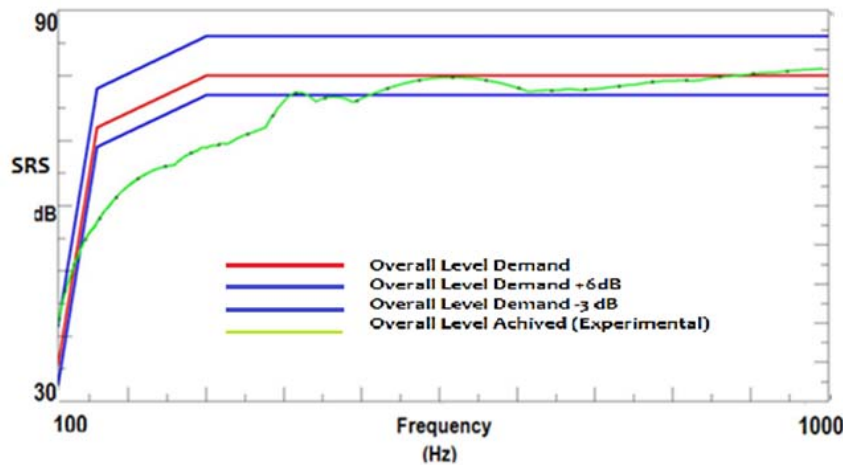

Fig. 15 SRS –Demand (Red), Tolerances (Blue), Measured (Green)

REFERENCES

[1] S(&)T: Demise Observation Capsule (DOC) for re-entry science and safety, <http://stcorp.nl/highlights/demise-observation-capsule-doc-re-entry-science-and-safety/Junaury 2019>.

[2] R. Gardi, G. Pezzella, S. Franchitti, R. Borrelli, C. Pirozzi, V. Quaranta, B. Tiseo, G. Bruno, "Additive Layer Manufacturing For Entry Capsules", 68th International Astronautical Congress (IAC), Adelaide, Australia, 2017.

[3] M. J. Kristensen, L. Ghizoni, P. Koch, DOC-PL-GS-0004 FLPP3, "Demise Observation Capsule (DOC) D24 Avionics and instrumentation Test Plan", Issue 1.4, February 2016.

[4] NASA, "Preferred Reliability Practices, practice no. pd-ed-1259, Acoustic Noise Requirement", May 1996.

[5] A. Calvi "Spacecraft Loads Analysis-An Overview, [http://www.ltas-vis.ulg.ac.be/cmsms/uploads/File/CALVI\\_Students\\_LIEGE\\_2011\\_6.pdf](http://www.ltas-vis.ulg.ac.be/cmsms/uploads/File/CALVI_Students_LIEGE_2011_6.pdf), January 2019.

[6] DOC S&T team, "DOC-PL-ST-0003-v1.5 D29 EQM-PFM Test Verification and Validation Plan", 2017

[7] Arianspace, Ariane 5 User's Manual, Issue 5 Revision 2, 2016 Roland Lagier, page 3-11.

[8] Arianspace, Vega User's Manual, 2014

[9] Arianspace, Soyuz User's Manual, 2012

[10] Arianspace Direction Commerciale Technical Support Department, Ariane Structure for Auxiliary Payload 5 –User's Manual, Issue 1 – Revision 0 – May 2000.