

# Influence of Insulation System Methods on Dissipation Factor and Voltage Endurance

Farzad Yavari, Hamid Chegini, Saeed Lotfi

**Abstract**—This paper reviews the comparison of Resin Rich (RR) and Vacuum Pressure Impregnation (VPI) insulation system qualities for stator bar of rotating electrical machines. Voltage endurance and tangent delta are two diagnostic tests to determine the quality of insulation systems. The paper describes the trend of dissipation factor while performing voltage endurance test for different stator bar samples made with RR and VPI insulation system methods. Some samples were made with the same strands and insulation thickness but with different main wall material to prove the influence of insulation system methods on stator bar quality. Also, some of the samples were subjected to voltage at the temperature of their insulation class, and their dissipation factor changes were measured and studied.

**Keywords**—Vacuum pressure impregnation, resin rich, insulation, stator bar, dissipation factor, voltage endurance.

## I. INTRODUCTION

### A. Insulation System in a Power Generator

WITH the application of the combination of fine mica flakes together with synthetic resin, mostly epoxy and/or polyester, two main high voltage insulation systems have been invented:

- VPI: In this system mica tapes with a low content of resin in combination with an impregnation resin during the pressure phase come into operation.
- RR: As indicated by the name and shown in Table 1, the tapes have considerably higher resin content. The resin in the tape is not only for manufacturing of itself and sound taping characteristics needed, but also to provide enough resin for the saturation and curing process of the ground wall insulation [1].

### B. Mica Tape Component Comparison

A mica tape consists normally of three or sometimes more main components. A major component is mica baked with a glass cloth carrier and resin as binder. Figs. 1 and 2 show mica tapes. Mica is extremely corona and ozone resistant and has one of the best electrical breakdown values at all. Glass has almost as good electrical properties as mica. The used resin, Epoxy or Polyester or a blend of them, is used normally for the binder and also for the impregnation process. The electrical values are, in comparison with Mica and glass, a lot worse, but still good enough to be an important component in HV insulation system [1].

Farzad Yavari, Hamid Chegini, and Saeed Lotfi are with the R&D MAPNA Co. Tehran, Iran (e-mail: yavari@mapnagenerator.com, chegini@mapnagenerator.com, lotfi@mapnagenerator.com).

TABLE I  
MEASURED INSULATION CONTENT

	Mica [g/m <sup>2</sup> ]	Resin [g/m <sup>2</sup> ]	Glass [g/m <sup>2</sup> ]	$\lambda$ [W/mK]	T.class
RR	151.93	118.35	34.34	0.26	F
VPI	170.57	12.17	22.54	0.23	F



Fig. 1 Mica tape for RR system



Fig. 2 Mica tape for VPI system

## II. EXPERIMENTAL SETUP

### A. Making Samples

As shown in Table II and Fig. 3, two different kinds of stator bar samples have been made by RR and VPI methods. In these cases, the insulated strand and the OCP & ECP have been considered the same material, and the dimensions of samples in both R.R and VPI system are the same but with different method of impregnation.

TABLE II  
STATOR BAR MANUFACTURING PROCESS

	Strand	OCP	ECP	Dim.	Method
RR	same	same	same	same	Auto Clave
VPI	same	same	same	same	VPI



Fig. 3 Stator bar dimension

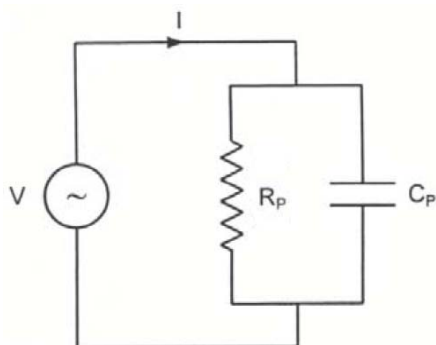

Fig. 4 Parallel circuit of resistor and capacitor

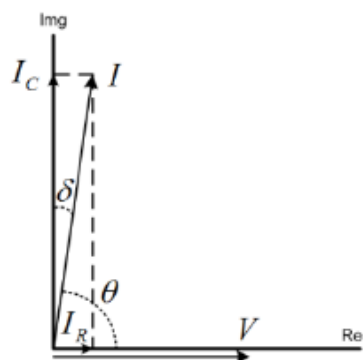

Fig. 5 Vector diagram of tangent delta:  $C_p$ : parallel capacitance;  $R_p$ : equivalent ac parallel resistor;  $\theta$ : phase angle;  $\delta$ : is loss angle

### B. Test Description

The tangent delta identifies the power loss in the insulating system. In this test, the insulation loss ratio is compared with the reference value for the insulating system. In fact, the phase difference of the voltage waveform and the current in the insulating system by the application of AC voltage represents the tangent delta. As shown in (1), the amount of dissipation factor or tangent delta is the loss current to charging current ratio [2].

$$DF = \frac{I_R}{I_c} = \frac{\sqrt{I^2 - I_c^2}}{I_c} \quad (1)$$

Figs. 4 and 5 show the equivalent circuit of the tangent delta measurement and its phasor diagram, which includes the parallel circuit of the resistor and capacitor. Equation (2) also shows the relationship between the tangent delta and the resistance and capacitance of the equivalent circuit [2].

$$DF = \frac{I_R}{I_c} = \frac{V/R}{V/(1/\omega C)} = \frac{1}{\omega RC} \quad (2)$$

### C. Test Procedure

In accordance with IEEE 1553-2002, the test voltage has been selected from the mentioned table. Schedule B is associated with a shorter minimum acceptable test life so for rated line-to line voltage of the winding, 15.75 kV, voltage endurance test voltage is 39.9 kV with shorter minimum acceptable test life expected 250 h [3].

For the second test, aging sub-cycle has been done according to IEC 60034-18-33. The test stresses are related to the standard reference ageing factor level [4].

The maximum rated voltage of the insulation system is 15.75 kV and the thermal class temperature is 155 C in accordance with IEC 60085 then electrical stress is 1.9Un with thermal stress Tc [5].

Figs. 6 and 7 show the set-up of DF measurement.

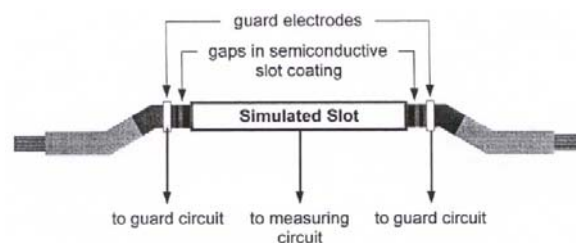

Fig. 6 Schematic of dissipation factor measurement on stator bar

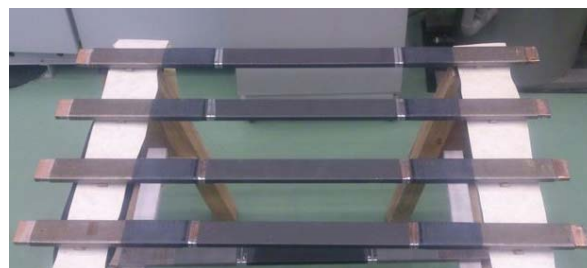

Fig. 7 Setup of sample to measure the tangent delta

### III. EXPERIMENTAL RESULT AND DISCUSSION

As it is shown in Table III, voltage 39.95 kV is applied on both stator bars with VPI and RR system in the same condition but their breakdown times are different. Stator bar with VPI system took 360 h to breakdown and stator bar with RR system tolerated 190 h.

TABLE III  
VOLTAGE ENDURANCE RESULT

Type	Test Voltage (kV)	Ambient Temperature (°C)	Ambient Humidity (%)	Breakdown (h)
VPI	39.5	6~20	30~62	360
R.R	39.5	6~14	31~55	190

**Tan Delta AS01**

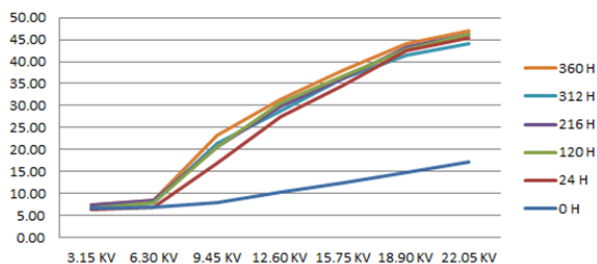

Fig. 8 Tan delta trend of AS01 (VPI system)

**Tan Delta Before Voltage**

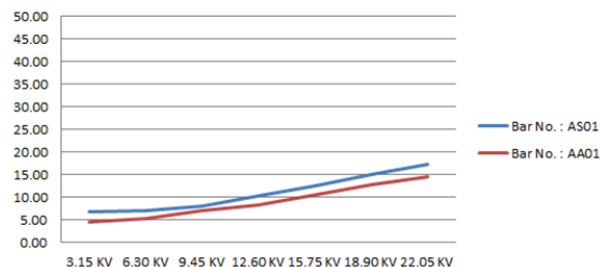

Fig. 10 Tan delta trend of AA01 & AS01

**Tan Delta AA01**

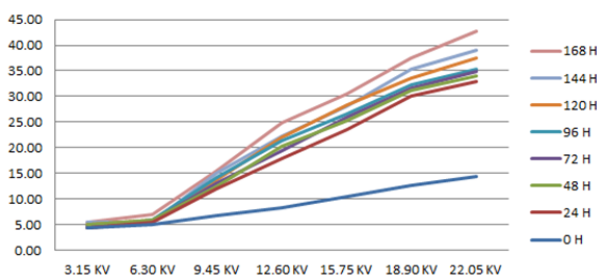

Fig. 9 Tan delta trend of AA01 (RR system)

TABLE IV  
 VOLTAGE ENDURANCE RESULT (WITH THERMAL STRESS)

Type	Test Voltage (kV)	Breakdown (h)
RR	29.2	2
VPI	29.2	28

**Tan Delta-AS02**

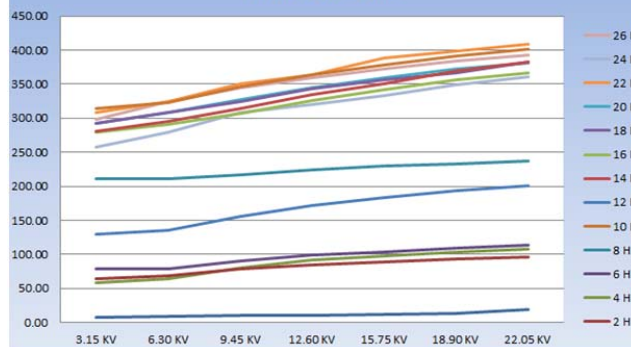

Fig. 11 Tan delta trend of AS01 (thermal & electrical stress)

**Tan Delta-AA02**

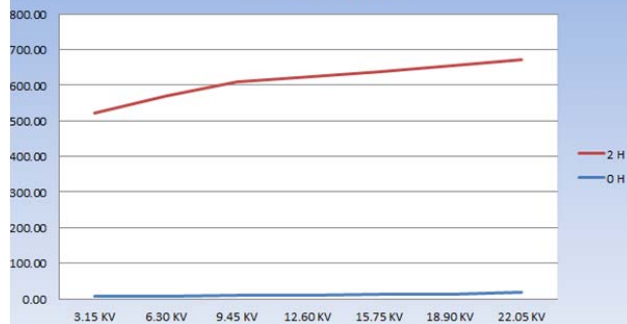

Fig. 12 Tan delta trend of AA01 (thermal & electrical stress)

As shown in Figs. 8 and 9, the value of the tangent delta after the application of the voltage is greatly increased, due to the separation of the initial layers of the insulation from the conductor, and then over time, the process of change is slowed down and the gradual increase will have.

Fig. 8 shows the trend of changes in the value of the Tangent Delta in the SVPI system. This trend suggests that in this type of insulation system, after the application of the voltage, a sharp increase in the value of the tangent delta is generated, but these changes compared to the system RR is less and over time, this trend is getting slower.

Before the voltage was applied, the value of the tangent delta was measured, as shown in Fig. 10. As it can be seen, the tangent delta value of the SVPI system is slightly higher, but they follow a similar increase in voltage as the voltage increases.

Two other samples of the RR and VPI system were also installed at 155 °C under a voltage of 29.2 kV in accordance with IEC 60034-18-33. As shown in Table IV, VPI system has a high electrical endurance in the class temperature of the F insulation system. Figs. 11 and 12 show the trend of changing tangent delta. On the other hand, the measured values of the tangent delta during the process of applying heat and voltage indicate that the changes in the tangent delta value after applying the voltage are much higher those of the previous one, which changes in the RR system relative to the VPI system far higher but because of the lack of electrical resistivity of the RR System, it was not possible to compare the trend of the tangent delta changes over time with the simultaneous application of the voltage and temperature, but as shown in Fig. 12, over time maintaining the voltage and temperature, the value tangent delta increases as these changes follow a roughly uniform pattern.

#### IV. CONCLUSIONS

Considering the necessity of comparing the two systems of RR and SVPI, it was attempted to produce samples with the same conditions (in terms of insulation thickness, shield dimensions and corona protection). Of course, two samples of these bars with RR insulation and Autoclave Baking System and two other samples were produced with VPI tapes and with a VPI system. Given that these specimens were intended for a voltage level of 15.75, therefore, with reference to the standards mentioned, both types of samples were subjected to the same voltages and measured tangent delta value at the same

steps with similar voltages. The results indicate that endurance of the electrical system of the SVPI system is far more than the RR system, with the application of about 40 kV to both types of bars; the RR system has a 190-hour electrical endurance and VPI system 360-hour electric endurance. On the other hand, in both systems, the RR and VPI, with the voltage applied, will change the amount of Tangent Delta, which seems to be due to the separation of the initial layers of the insulation from the conductor, and then, over time, these changes will be reduced by maintaining the voltage values. In terms of simultaneous applying of the voltage and heat, as shown in the diagrams and tables, the electrical endurance of the bar made with the RR system has a lower electrical endurance, but the changes in the tangent delta value in this case over time, while maintaining simultaneous temperature and voltage, are higher than just the voltage applied.

#### ACKNOWLEDGMENT

This Research was supported by MAPNA IRAN. Thanks are due to colleagues from MAPNA Engineering and Manufacturing Company for assistance with the experiments.

#### REFERENCES

- [1] Ladstätter, W., Marek, P., Grubelnik, W., & Senn, F. (2006). New insulation technology impacts generator design. In Power-Gen International Conference.
- [2] IEEE Recommended Practice for Measurement of Power Factor Tip-Up of Electric Machinery Stator Coil Insulation," in IEEE Std 286-2000 , vol., no., pp.i-29, 2001
- [3] IEEE Trial-Use Standard for Voltage-Endurance Testing of Form-Wound Coils and Bars for Hydrogenerators," in IEEE Std 1553-2002 , vol., no., pp.0 1-, 2003
- [4] IEC60034-18-33:2010." Rotating electrical machines - Part 18-33: Functional evaluation of insulation systems"
- [5] IEC60085:2007-11 Edition4.0," Thermal evaluation and designation-Table.1:Thermal Class Assignment."