

# Exergy Analysis of Vapour Compression Refrigeration System Using R507A, R134a, R114, R22 and R717

Ali Dinarveis

**Abstract**—This paper compares the energy and exergy efficiency of a vapour compression refrigeration system using refrigerants of different groups. In this study, five different refrigerants including R507A, R134a, R114, R22 and R717 have been studied. EES Program is used to solve the thermodynamic equations. The results of this analysis are shown graphically. Based on the results, energy and exergy efficiencies for R717 are higher than the other refrigerants. Also, the energy and exergy efficiencies will be decreased with increasing the condensing temperature and decreasing the evaporating temperature.

**Keywords**—Energy, exergy, refrigeration, temperature, thermodynamic.

## I. INTRODUCTION

ONE of the most important factors affecting the design of HVAC equipment is the type and property of the refrigerant used in it. The selection of refrigerant involves many different thermo-physical properties that sometimes some of these properties are in conflict with each other. The refrigerant, basically, should have a wide range of required properties. Chlorofluorocarbon compounds (CFC) which were often used in domestic systems are replaced with Hydrofluorocarbon compounds (HFC), due to destruction of ozone layer. Researchers have shown that HFC leads to less destruction of the ozone layer than CFC. HFC does not destroy the ozone layer and still it has many desirable properties of CFC and HCFC. For this reason, these refrigerants have been considered as replacement refrigerants [1]-[5]. The use of hydrocarbon refrigerants (HC) has the less environmental impact compared to HFC. However, to be able to use these refrigerants, due to their flammability, there should be a change in the refrigeration system and its components design.

Since R717 is less dangerous compared to hydrocarbons, and because of its zero greenhouse and ozone destruction potential, its application will be increased. R717 is lighter than air and therefore reduces the risk of poisoning. R717 has a strong smell that is easily felt and leads to detection of its leakage location. It also has a high latent heat of evaporation that reduces the amount of mass flow rate in refrigeration systems.

To evaluate the efficiency of a vapour compression refrigeration system, energy efficiency (first law of

thermodynamics) which is called coefficient of performance is used. But in order to evaluate the quality of energy and thermodynamic analysis, only the first law is not enough. The second law of thermodynamics states that energy has both quantity and quality. Trying to quantify the quality or energy potential based on the second law of thermodynamics led to definition of entropy and exergy. Exergy or availability indicates the maximum work potential of a system under determined conditions [6]-[10]. Many studies have been done by different researchers in relation to refrigerants and exergy analysis of refrigeration system [11]-[17]. Leidenfrost et al. [18] studied the exergy analysis and the performance of a refrigeration system using R12. Wongwises and Dalkilic [19] studied the effect of sub-cooling and superheating temperatures on performance of refrigeration system with R134a, R152a, R32, R290, R1270 and R600. To compare the performance of vapour compression refrigeration systems, experimental analysis was done on the refrigerants R22, R407c, R507 and R417A [20]. Park et al. studied experimentally the performance of R431A and R22 on air condition systems [21].

## II. THERMODYNAMIC ANALYSIS

Fig. 1 (a) shows the vapour compression refrigeration system components including a compressor, condenser, heat exchanger, expansion valve and evaporator. In order to achieve higher system efficiency, as well as suction superheat vapour, a heat exchanger is used. Fig. 1 (b) shows the pressure-enthalpy diagram for the cycle [22].

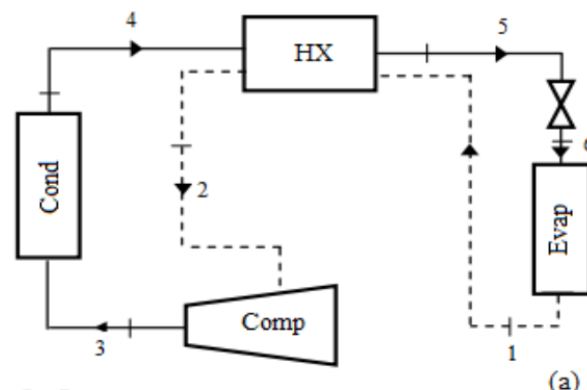

Ali Dinarveis has B.S. degree in Physics from Shahid Chamran University of Ahwaz, Iran (e-mail: ali.dinarveis@yahoo.com).

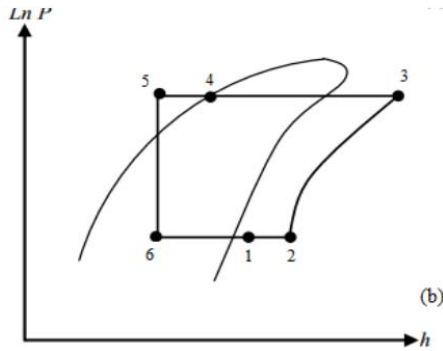

Fig. 1 (a) Schematic views of the system components. (b) Schematic drawing of the cycle on the Ln P-h diagram

Superheated vapour usually leaves the evaporator due to heat transfer (state 1). The pressure drop is ignored in all system components. So it can be considered constant evaporator temperature. The refrigerant temperature increases due to heat transfer within heat exchanger (state 2). The superheated vapour expands by compressor. Compressor conditions are considered according to actual conditions (state 3). The refrigerant heat is transferred to environment in condenser sensibly and latently. Then the liquid refrigerant (state 4) would be sub-cooled after passing heat exchanger and then its temperature decreases (state 5). Heat transfer occurs between the suction vapour and liquid refrigerant within heat exchanger. The sub-cooled refrigerant has two-phase state after passing from expansion valve (state 6).

In this study, five refrigerants i.e., R507A, R134a, R114, R22 and R717 have been theoretically investigated. In this paper, a vapour compression refrigeration system with a specified capacity is selected and the effect of various condensing and evaporating temperatures on energy and exergy efficiency of the system is investigated.

Since exergy is consumed and destroyed during process because of entropy generation, thermodynamic analysis should be done to determine the amount of exergy destruction. In order to analyze the first and second law of thermodynamics, the following assumptions have been considered:

- The pressure drop in pipelines is ignored.
- The steady state is considered for all system components.
- The heat loss within the system is ignored.
- The heat loss within heat exchanger is ignored.
- The kinetic and potential energy of the system is ignored.
- The power consumption of the condenser and evaporator fans is ignored.

### III. EQUATIONS

Therefore, the amount of exergy is defined as follows:

$$\Psi = h - h_0 - T_0(s - s_0) \quad (1)$$

The irreversibility of system components is calculated from exergy balance as:

$$I = EX_{in} - EX_{out} \quad (2)$$

Using (1) and (2) and previous assumptions, the first and

second laws of thermodynamic for system components are determined as follows:

Evaporator:

$$Q_{ev} = m_r (h_1 - h_6) \quad (3)$$

$$I_{ev} = m_r (\Psi_1 - \Psi_6) + Q_{ev} \left(1 - \frac{T_0}{T_{ev}}\right) \quad (4)$$

Compressor:

$$W_c = m_r (h_3 - h_2) \quad (5)$$

The refrigerant enthalpy ( $h_{3s}$ ) is based on actual condition that is determined as follows:

$$h_3 = \left(\frac{h_{3/8} - h_2}{h_c}\right) + h_2 \quad (6)$$

where,  $h_{3,s}$  is refrigerant enthalpy in isentropic condition. The electric power of compressor engine is:

$$W_{el} = \frac{W_c}{\eta_{mech} \cdot \eta_{el}} \quad (7)$$

The irreversibility of the compressor is:

$$I_{comp} = m_r (\Psi_2 - \Psi_3) + W_{el} \quad (8)$$

Condenser:

$$Q_{cond} = m_r (h_3 - h_4) \quad (9)$$

$$I_{cond} = m_r (\Psi_3 - \Psi_4) - Q_{cond} \left(1 - \frac{T_0}{T_{COND}}\right) \quad (10)$$

Expansion valve:

$$h_5 = h_6 \quad (11)$$

$$I_{exp} = m_r (\Psi_5 - \Psi_6) \quad (12)$$

Heat exchanger:

$$Q_{hx} = m_r (h_4 - h_5) = m_r (h_2 - h_1) \quad (13)$$

$$I_{hx} = m_r [(\Psi_4 - \Psi_5) - (\Psi_2 - \Psi_1)] \quad (14)$$

Coefficient of performance and irreversibility of the system is determined as follows:

$$COP = \frac{Q_{ev}}{W_{el}} \quad (15)$$

$$I_{total} = I_{ev} + I_{comp} + I_{cond} + I_{exp} + I_{hx} \quad (16)$$

The exergy efficiency is defined as:

$$\eta_{ex} = \frac{\Psi_1 - \Psi_6}{W_{el}} \quad (17)$$

#### IV. RESULTS ANALYSIS

Figs. 2-6 show the changes of the exergy destruction, COP and the exergy efficiency of the refrigeration system for three different condenser temperatures. In Fig. 2, the exergy destruction of various refrigerants with condenser temperature of 30°C has been shown. Figs. 3 and 4 show the same for condenser temperatures of 40°C and 50°C, respectively. The maximum exergy destruction value has been obtained for R507A in all condenser temperatures. The exergy destruction value increases with increasing the condenser temperature. Fig. 5 shows that the COP significantly increases with reduction of evaporator temperature at condenser temperature of 30°C compared to condenser temperatures of 40°C and 50°C. Maximum COP has been obtained for R717. The difference between COP values for these refrigerants is too small. The minimum COP is obtained for R507A. Fig. 6 shows the exergy efficiency for the refrigerants in various evaporator and condenser temperatures. The maximum exergy efficiency value has been obtained for R717 in all condenser temperatures. Based on the results, R22T, R114 and R134a behave, similarly.

Open Science Index, Energy and Environmental Engineering Vol:13, No:7, 2019 publications.waset.org/10010578.pdf

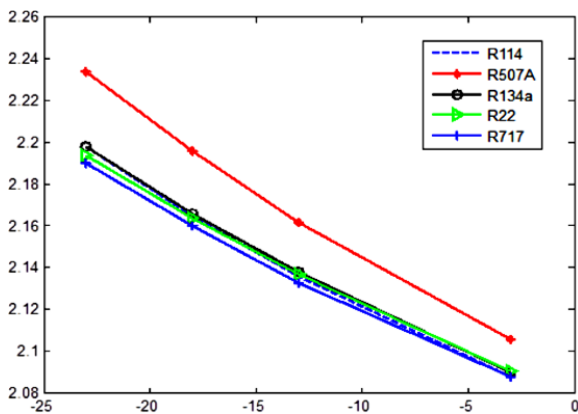

Fig. 2 The exergy destruction of various refrigerants with condenser temperature of 30°C

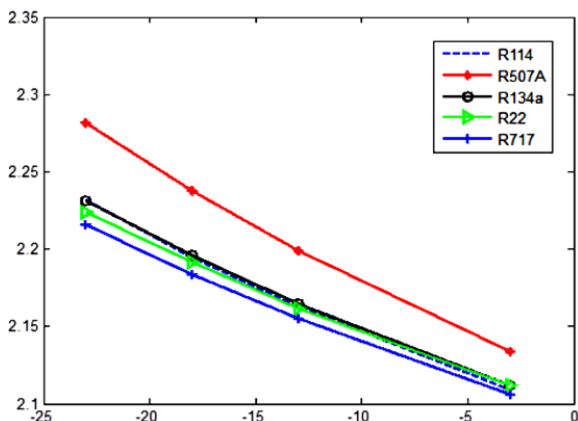

Fig. 3 The exergy destruction of various refrigerants with condenser temperature of 35°C

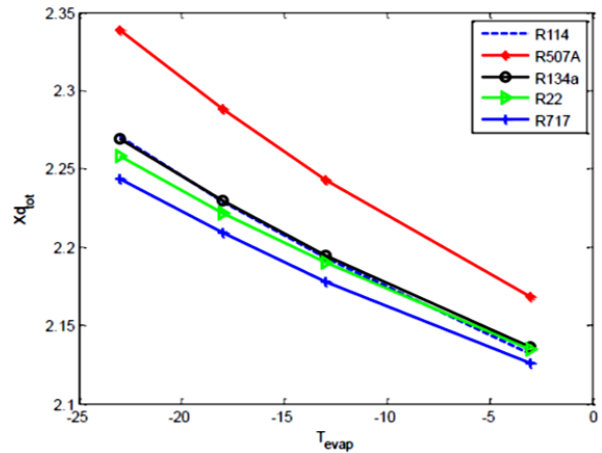

Fig. 4 The exergy destruction of various refrigerants with condenser temperature of 40°C

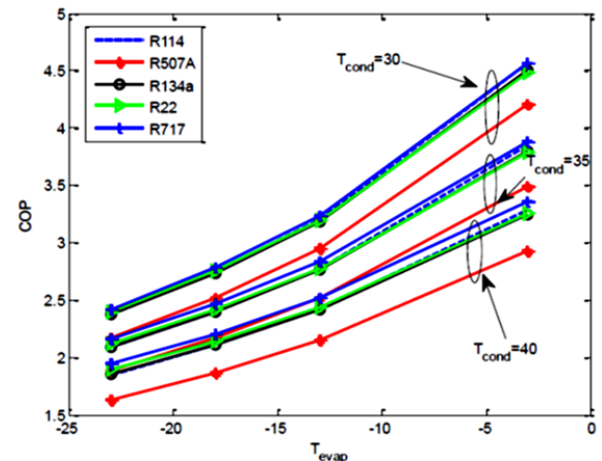

Fig. 5 The COP of various refrigerants based on different condenser and evaporator temperature

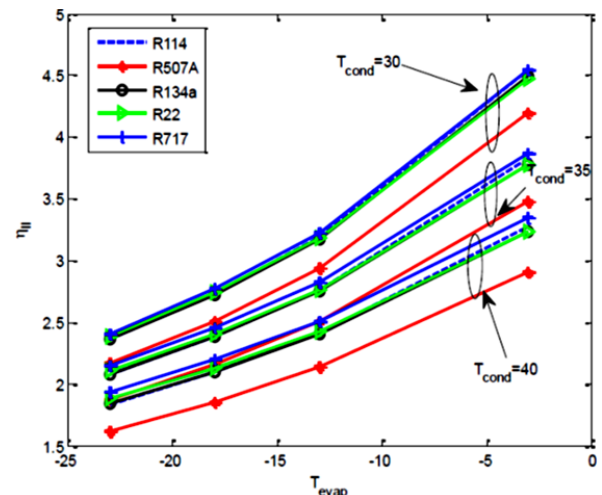

Fig. 6 The exergy efficiency of various refrigerants based on different condenser and evaporator temperatures

#### V. CONCLUSION

A comparative study has been done by theoretical analysis

for five refrigerants including R507A, R134a, R114, R22 and R717. Such a comparison between energy performance and exergy efficiency of these refrigerants give valuable information to refrigeration systems designers. The greatest amount of energy and exergy efficiencies is obtained for R717 for all operating conditions and the maximum exergy destruction is obtained for R507A for all condenser and evaporator temperatures.

It is clear that the COP increases with increasing the evaporator temperature, however the irreversibility and exergy destruction decrease. With specified actual condition, vapour compression refrigeration system with R717 behaves better. R134a, R114 and R22 almost have the same view.

TABLE I  
 OPERATING CONDITIONS OF THE REFRIGERATION SYSTEM

Environment Temperature	293 k
Environment Pressure	100 kpa
Evaporator Temperature	248-273 k
Condenser Temperature	303, 308, 313 k
Superheating Temperature	3 k
Super heating in HX	3 k
Compressor Isentropic Efficiency	80%
Compressor Mechanical Efficiency	90%
Electric Motor Efficiency	90%

#### REFERENCES

- [1] ASHRAE standard 34-2007: Designation and safety classification of refrigerants. ASHRAE, Atlanta GA; 2007.
- [2] H. C. Bayrakci, A. E. Ozgur, Energy and exergy analysis of vapor compression refrigeration system using pure hydrocarbon refrigerants. *Int J Energy Res*, 33 (2009), pp. 1070–1075.
- [3] M. Mohanraja, S. Jayaraj, C. Muraliedharan, Environment friendly alternatives to halogenated refrigerants – a review. *Int J Greenh Gas Control*, 3 (2009), pp. 108–119.
- [4] Domanski PA, Didion DA. Impact of refrigerant property uncertainties on prediction of vapour compression cycle performance. U.S. Department of Commerce, National Bureau of Standards, Gaithersburg; 1987.
- [5] M. Bhatti, Historical look at chlorofluorocarbon refrigerants ASHRAE Trans (Part 1) (1999), pp. 1186–1206.
- [6] Gaggioli RA. Available energy and exergy. *International Journal of Applied Thermodynamics* 1998;1:1–8.
- [7] Wark KJ. *Advanced thermodynamics for engineers*. New York: McGraw-Hill; 1995.
- [8] Bejan A. *Advanced engineering thermodynamics*. New York: Wiley; 1988.
- [9] Moran MJ. *Availability analysis: a guide to efficient energy use*. Englewood Cliffs, NJ: Prentice-Hall; 1982.
- [10] Bejan A. *Entropy generation through heat and fluid flow*. New York: Wiley; 1982.
- [11] Torres-Reyes E, Picon-Nune ZM, Cervantesortari DE, Gortari J. Exergy analysis and optimization of a solar assisted heat pump. *Energy* 1998;23:337–44.
- [12] Bejan A. Theory of heat transfer-irreversible refrigeration plants. *International Journal of Heat Mass Transfer* 1989;32:1631–9.
- [13] Wall G. Optimization of refrigeration machinery. *International Journal of Refrigeration* 1990;14:336–40.
- [14] Akau RL, Schoenhals RJ. The second law efficiency of a heat pump system. *Energy* 1980;5:853–63.
- [15] Chen J, Chen X, Wu C. Optimization of the rate of exergy output of a multistage endoreversible combined refrigeration system. *Exergy*
- [16] Kaygusuz K, Ayhan T. Exergy analysis of solar assisted heat pump systems for domestic heating. *Energy* 1993;18:1077–85.
- [17] Torres-Reyes E, Cervantes DE, Gortari J. Optimal performance of an irreversible solar assisted heat pump. *Exergy* 2001;1:107–11.
- [18] Leidenfrost W, Lee KH, Korenic KH. Conservation of energy estimated

by second law analysis of power-consuming process. *Energy* 1980;5:47–61.

- [19] A. S. Dalkilic, S. Wongwises, A performance comparison of vapour-compression refrigeration system using various alternative refrigerants, *Int. Commun. Heat Mass Transfer* 37 (2010) 1340–1349.
- [20] R. Cabello, E. Torrella, J. Navarro-Esbri, Experimental evaluation of a vapour compression plant performance using R134a, R407C and R22 as working fluids, *Appl. Therm. Eng.* 24 (2004) 1905–1917.
- [21] J. Navarro-Esbri, R. Cabello, E. Torrella, Experimental evaluation of the internal heat exchanger influence on a vapour compression plant energy efficiency working with R22, R134a and R407C, *Energy* 30 (2005) 621–636.
- [22] HC. Bayrakci, AE. Ozgur, Energy and exergy analysis of vapor compression refrigeration system using pure hydrocarbon refrigeration, *Int. J. Energy Res.* 2009; 33:1070–1075.