

# A Data Driven Approach for the Degradation of a Lithium-Ion Battery Based on Accelerated Life Test

Alyaa M. Younes, Nermine Harraz, Mohammad H. Elwany

**Abstract**—Lithium ion batteries are currently used for many applications including satellites, electric vehicles and mobile electronics. Their ability to store relatively large amount of energy in a limited space make them most appropriate for critical applications. Evaluation of the life of these batteries and their reliability becomes crucial to the systems they support. Reliability of Li-Ion batteries has been mainly considered based on its lifetime. However, another important factor that can be considered critical in many applications such as in electric vehicles is the cycle duration. The present work presents the results of an experimental investigation on the degradation behavior of a Laptop Li-ion battery (type TKV2V) and the effect of applied load on the battery cycle time. The reliability was evaluated using an accelerated life test. Least squares linear regression with median rank estimation was used to estimate the Weibull distribution parameters needed for the reliability functions estimation. The probability density function, failure rate and reliability function under each of the applied loads were evaluated and compared. An inverse power model is introduced that can predict cycle time at any stress level given.

**Keywords**—Accelerated life test, inverse power law, lithium ion battery, reliability evaluation, Weibull distribution.

## I. INTRODUCTION

LITHIUM ion batteries (LIB) are low-maintenance rechargeable energy storage. Rechargeable batteries with lithium metal on the anode could provide extraordinarily high energy densities [1]. Technological developments are leading LIB's rapid advancement into medium- and large-scale applications, most notably hybrid electric vehicles (HEV), plug-in HEV, battery electric vehicles (BEV), and energy storage system for buildings. Since its commercialization, the LIB has facilitated a remarkable advance in portable electronics and broadened the accessibility to IT throughout society [2]. The LIB is now used in practically every field of consumer electronics, in accordance with market needs [3]. LIB have a wide range of applications and are an integral part to the success of some applications such as satellites and HEV, this leads to the need for testing and evaluating LIBs.

Collecting and analyzing life data for products and systems running under regular operating conditions is impractical. This can be attributed to the long life time of a product or the short time interval between the design of a product and its release. On the other hand, it is quite difficult to carry out life testing on a product running continuously under regular operating conditions [4]. In such cases, failure assessment of products and reliability evaluation calls for attempting to accelerate

product failures. Accelerated life tests (ALTs) are widely used for testing electronic components. Nogueira et al. [5] Hao et al. [6], [7], Sawant and Christou [8], and Yazdan Mehr et al. [9] all used ALT to investigate LED components. Kim et al. [10], Virkki et al. [11], Kim et al. [12], and Kalaiselvan and Rao [13] used ALT and HALT (Highly Accelerated Life Test) to study the lifetime and failure of different capacitor types. Gu et al. [14] applied a new method of ALT based on the Grey System Theory for a model-based lithium-ion battery life evaluation system. Chiodo et al. [15] proposed a method which considers the randomness of battery parameters. Based on available experimental data, the lifetime probability distribution of these batteries was estimated by means of a Weibull model. Chung and Hsiao [16] performed statistically accelerated degradation tests to validate the aging model for predicting the power fade of LIB. Thomas et al. [17] conducted a statistically designed accelerated aging experiment to investigate the effects of aging time, temperature, and state-of-charge (SOC) on the performance of lithium-ion cells. Takei et al. [18] estimated cycle life of lithium secondary battery using ALT and extrapolation method.

ALT data can also be used to help determine how a system will perform under circumstances other than its normal operating conditions. Testing at elevated loads can be used to predict -with reasonable accuracy- the reliability and life time of products. For some applications, determining the mode of failure can be of equal importance as the time of failure. Failure does not necessarily mean that the system or component have been destructed or stopped working altogether. In many cases, failure refers to a certain level of degradation in performance.

One of the most common types of ALT is step-stress tests [19]. A set of units can be tested under a certain stress level for a specific period of time. If at the end of test period, some units are still functioning they will be subjected to a higher stress level for another amount of time. On the other hand, some step-stress tests monitors the direct relationship between product failure and its performance and degradation, throughout the test duration [20]. Such case represents a degradation test with cumulative damage that can be measured over time to estimate product reliability without the need for a complex model.

Methods used for reliability evaluation are based on either the design criteria or performance data, i.e. it can either be model based or data driven. Available literature is mainly model-based, while less literature is available on data driven approach which leaves a wide area that needs to be broached.

Alyaa M. Younes is with Alexandria University, Egypt (e-mail: alyamohammadyounes@gmail.com).

The present work aims to evaluate the reliability of a Laptop Li-ion battery (type TKV2V) LIB based on data collected under ALT. A degradation test has several advantages over a life test as a reliability analysis approach. Using degradation data directly relates reliability to physical characteristics. Chung et al. [21] used statistically accelerated degradation tests to validate a lithium-ion battery aging model for predicting the power fade of 18650-size cells. Thomas et al. [17] conducted a degradation test to investigate the effects of aging time, temperature, and SOC on the performance of lithium-ion cells.

In the available literature, the reliability of LIB is investigated in terms of the number of cycles until failure with little consideration of the cycle duration, which is very critical in some applications including satellites and electric vehicles.

## II. THEORETICAL ANALYSIS

ALT models can be used to predict the relationship between life time or failure rate and varying stress levels. The data collected during these tests can be used to calculate the expected life time and performance at normal operating conditions. It is assumed that the different stress levels applied will not affect the failure distribution shape [22].

Three acceleration models are most commonly used; Inverse Power Law, Arrhenius Acceleration Model and Miner's Rule. The Arrhenius Acceleration Model can be used only when the stress factor is temperature, while in the inverse power law any kind of stress is applicable. In Miner's Rule [23], it is assumed that the critical damage that causes failure is a fixed value, and the damage accumulates linearly. Both assumptions are not applicable in the present study, so the inverse power law is the most appropriate choice.

In the inverse power, law component life is inversely related to a power of the dominant stress.

$$\frac{\text{Life at normal stress}}{\text{Life at accelerated stress}} = \left( \frac{\text{Accelerated stress}}{\text{Normal stress}} \right)^N \quad (1)$$

where N is the acceleration factor [24].

Weibull distribution can be used to model a variety of life behaviors depending on the values of its parameters. These parameters can be estimated via graphical or analytical methods. In the present study, the single factor linear regression with median rank model is selected to estimate these parameters and evaluate the probability density function  $f(T)$ , reliability function  $R(T)$ , and failure rate  $\lambda(T)$ .

$$f(T) = \frac{\beta}{\eta} \left( \frac{T-\gamma}{\eta} \right)^{\beta-1} e^{-\left[ \frac{T-\gamma}{\eta} \right]^\beta} \quad (2)$$

$$R(T) = e^{-\left[ \frac{T-\gamma}{\eta} \right]^\beta} \quad (3)$$

$$\lambda(T) = \frac{f(T)}{R(T)} = \frac{\beta}{\eta} \left( \frac{T-\gamma}{\eta} \right)^{\beta-1} \quad (4)$$

where  $\beta$ : shape parameter;  $\eta$ : scale parameter;  $\gamma$ : location parameter.

In the present study, the location parameter ( $\gamma$ ) is assumed to be zero, thus reducing the Weibull parameters to two parameters. The shape parameter characterizes the system failure trend, and the scale parameter characterizes the lifetime of the system. In the present study, the least squares regression of Y on X is used for ranking regression [25]. For the two parameter Weibull distribution, the cumulative density function,  $F(T)$  in the form of a single factor linear equation is used to estimate the system reliability.  $F(T)$  is estimated for each order of the Time-to-Failure (TTF) sorted in ascending order, using median rank method. Equation (7) is used to estimate y as in (8). The least squares estimator, the slope,  $a$ , and the intercept,  $b$ , are calculated by regression analysis to estimate the two Weibull parameters ( $\beta, \eta$ ) as follows [25].

$$\ln[-\ln(1 - F(T))] = -\beta \cdot \ln(\eta) + \beta \cdot \ln(T) \quad (5)$$

$$y_i = a + b x_i \quad (6)$$

$$MR\% = \frac{i-0.3}{N+0.4} \cdot 100 \quad (7)$$

where

$$y = \ln[-\ln(1 - F(T))] \quad (8)$$

$$x_i = \ln(T_i)$$

$$b = \beta$$

$$a = -\beta \ln(\eta)$$

i: order number of failure time, N: number of measurements,  $T_i$ : Time-to-Failure, a, b: least square estimators.

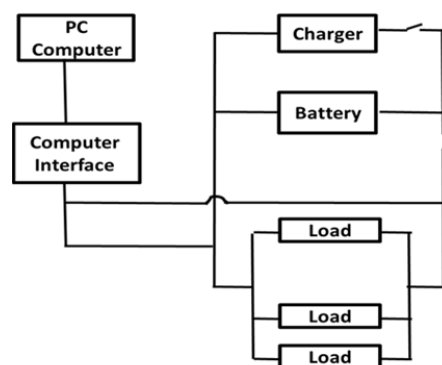

Fig. 1 A schematic diagram of the experimental setup

## III. EXPERIMENTAL WORK

An experimental investigation was carried out to study the effect of stress level applied on the cycle time of a Lithium ion laptop battery (type TKV2V). Fig. 1 shows a schematic diagram of the experimental system used for the ALT of the Li-Ion battery. A PC Computer was used to record and analyze the data. A specially designed Computer Interface was used to acquire and facilitate data manipulation. A charger was used to recharge the depleted battery. Specifically, selected sets of resistors were used to alter the stress level.

After charging the battery, a known load (resistance) was connected across the battery to start the discharge cycle. The computer monitors and record battery voltage during discharge cycles. The battery was tested at a 100% depth of discharge (DoD). Using Arduino Uno software, the cycle time against the voltage value was recorded for each discharge cycle. Fig. 2 shows a typical record of data acquired during a discharge cycle. The figure shows that battery voltage decreases gradually from  $\approx 12$  V to  $\approx 9.5$  V, and then drops suddenly to zero. The discharge cycle time is estimated when the voltage reaches a value of 9 V. To evaluate the effect of the value of load (stress) on the cycle time, the battery was tested under six different load values. The discharge cycle time was estimated for each load. In fact, the battery was run ten times under each load and average cycle time at each load was considered. The resistance across the battery was selected to give six different values of the current density (load) of 0.37 Am, 1.11 Am, 1.48 Am, 1.85 Am, 2.22 Am, and 2.96 Am.

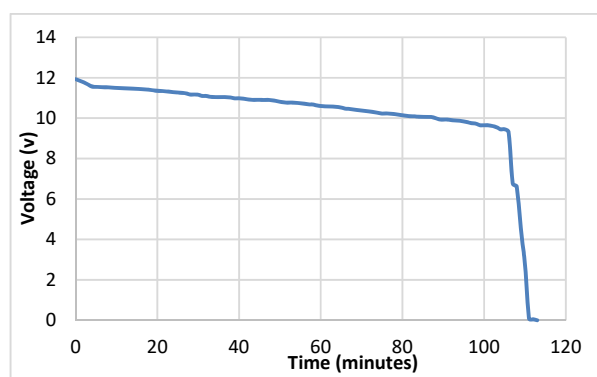

Fig. 2 A typical record of battery voltage versus time during a discharge cycle

#### IV. RESULTS

In this section, the evaluation of the effect of stress level on battery performance is presented. Fig. 3 shows discharge cycles of tested battery at different stress levels. The failure is defined as the inability of system to perform its intended function, when the battery is discharged and fails to supply the design voltage that is a form of failure. For each stress level, the test was repeated ten times and time to failure recorded each time. Each ten readings were sorted in an ascending order to be ranked with median rank based on (7). Fig. 4 illustrates the estimated TTF for the ten discharge cycles at the lowest stress level arranged in an ascending order. The TTF ranges between 392 min and 404 min with an average of 397.4 min. Fig. 5 shows the estimated TTF for the ten discharge cycles at the five higher stress levels arranged in an ascending order. It is obvious from Figs. 4 and 5 that the time to failure decreases as the stress level increases. Moreover, the change in the TTF as the stress level increases is not linear. The average TTF for the six stress levels was 397.4, 112.8, 87.8, 76, 66.3, 51.4 respectively as given in Table I.

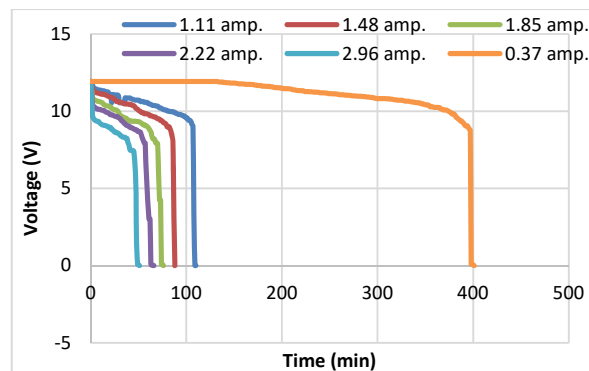

Fig. 3 Discharge cycles of a battery at different stress levels

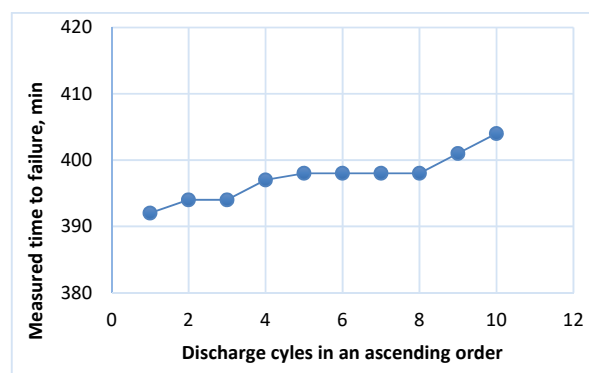

Fig. 4 TTF for the ten discharge cycles arranged in an ascending order for the lowest (0.37 amp) stress level

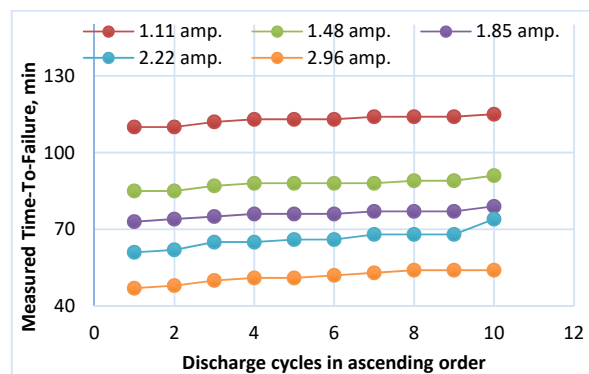

Fig. 5 TTF for the ten discharge cycles arranged in an ascending order for different stress levels

Stress Level (Amp.)	Average TTF (minutes)
0.37	397.4
1.11	112.8
1.48	87.8
1.85	76
2.22	66.3
2.96	51.4

Figs. 6-9 show the Reliability function, Failure function, and Probability density function at all considered stress levels. Regarding the Reliability function, it is obvious that the

average TTF changes by changing the stress level, (see also Fig. 7). Also, the maximum and minimum values for the reliability function differ from one stress level to the other. The reliability function at stress levels 1.48 amp and 1.85 amp are the steepest which can be related to them reaching the highest failure rates as is quite visible in Fig. 8. On the other hand, the failure rate increases gradually as the stress level increase up to 1.48amp then decreases again which can be attributed to the pattern normally followed by the failure rate under ALT. The probability density function has the highest value at a stress level 1.48 amp, and the lowest value at 0.37 amp (see Fig. 6) which is the closest to normal operating conditions, thus conforming with the pattern followed by the failure rate. At a stress level of 2.22 amp, it is visible from the shape of the reliability function, failure rate, and probability density function, that reading number 10 is odd. Table III shows the values of the shape and scale parameters for each of the stress levels used to calculate the Reliability function  $R(T)$ , Failure rate  $\lambda(T)$ , and Probability density function  $f(T)$  at each stress level.

As shown in Table II and Fig. 6, reliability decreases as the TTF increases, and the failure rate increases as TTF increases. The probability density however increases up to a certain limit then starts to decrease again.

TABLE II

RELIABILITY FUNCTION, FAILURE RATE, AND PROBABILITY DENSITY FUNCTION VALUES FOR THE TEN TRIALS AT STRESS LEVEL 0.37 AMP

Reading order	Time to Failure (min)	Reliability Function	Failure Rate	Probability Density Function
N	T <sub>i</sub>	R(T)	$\lambda(T)$	f(T)
1	392	0.890	0.035	0.032
2	394	0.8079	0.065	0.052
3	394	0.808	0.065	0.052
4	397	0.590	0.159	0.094
5	398	0.490	0.214	0.105
6	398	0.490	0.214	0.105
7	398	0.490	0.214	0.105
8	398	0.490	0.214	0.105
9	401	0.174	0.520	0.091
10	404	0.014	1.258	0.018

TABLE III

LEAST SQUARE ESTIMATORS FOR EACH OF THE STRESS LEVELS

Stress Level (Amp.)	Least Square Estimators		
	a	b= $\beta$	$\eta$ (minutes)
0.37	-715.355	119.439	399.130
1.11	-336.476	71.093	113.621
1.48	-228.462	50.938	88.689
1.85	-209.898	48.349	76.809
2.22	-81.455	19.302	68.031
2.96	-87.679	22.129	52.572

The inverse power law model can be used to characterize the relationship between system lifetime (L) and stress level (V) as expressed in (9) and (10).

$$L(V) = \frac{1}{KV^n} \quad (9)$$

or,

$$\ln(L) = -\ln K - n \ln V \quad (10)$$

where (L): system lifetime, (V): stress level, (K, n): inverse power law model parameters.

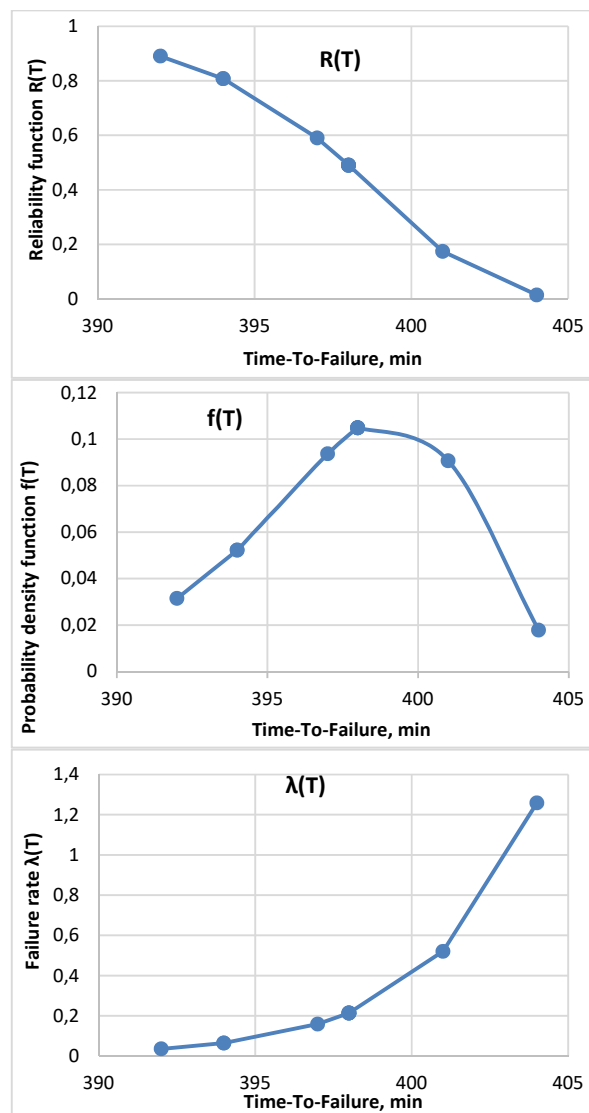

Fig. 6 Reliability function  $R(T)$ , Probability Density Function  $f(T)$ , and Failure Rate  $\lambda(T)$  at stress level 0.37 amp

Equation (10) is used to linearize the system life-stress relationship; this allows the use of linear regression instead of non-linear regression to calculate the extrapolated TTF at any stress level. Using the inverse power law and linear regression, the model in Fig. 10 was predicted. Fig. 11 shows the values calculated using the predicted model versus the actual measured values at each stress level. From Table IV, it is clear that the maximum percentage error in the predicted model is 11.4%, which can be considered as insignificant thus proving the validity of the predicted model. Using extrapolation based on the predicted model, if the stress (load) is reduced to 0.2 amp, the expected cycle time will be 678.5 min, but at a stress

level of 4.0 amp, the expected cycle time will go down to 36.6 min.

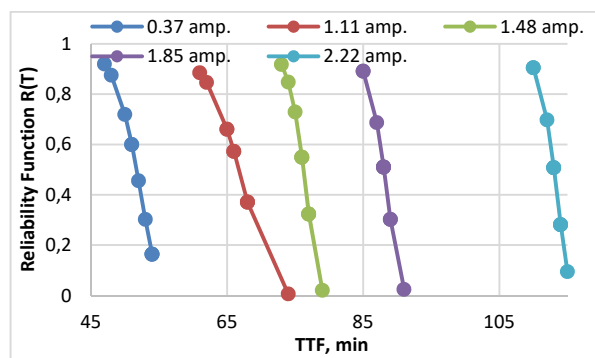

Fig. 7 Reliability function for the different stress levels

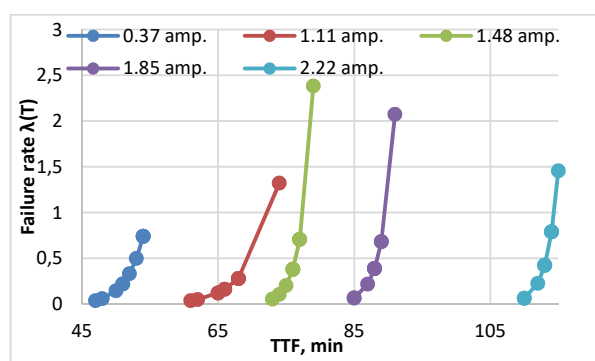

Fig. 8 Failure rate for the different stress levels

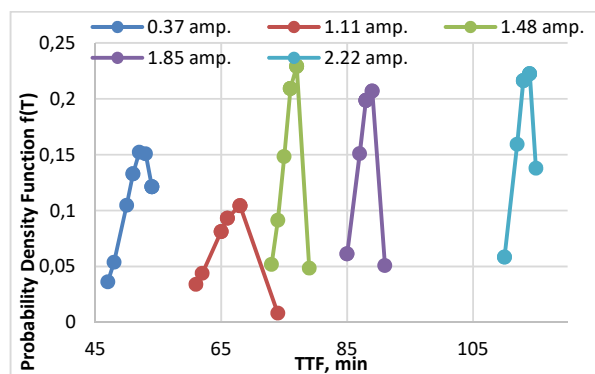

Fig. 9 Probability density function for the different stress levels

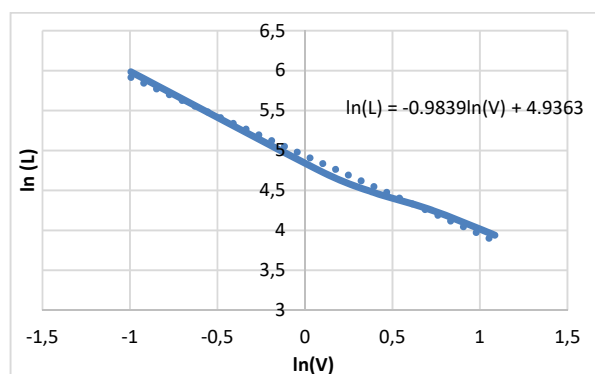

Fig. 10 Inverse power model

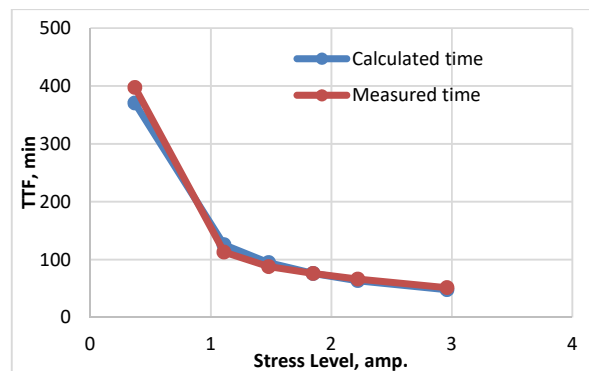

Fig. 11 The measured time vs calculated time at each stress level

TABLE IV  
 CALCULATED TIME, MEASURED TIME, % ERROR AT EACH STRESS LEVEL

Stress Level	Calculated time (min)	Measured time (min)	% Error
0.37	370.386	397.4	6.80
1.11	125.665	112.8	11.41
1.48	94.686	87.8	7.84
1.85	76.022	76	0.03
2.22	63.538	66.3	4.17
2.96	47.874	51.4	6.86

## V. CONCLUSION

An experimental setup was designed and built to investigate the degradation behavior of a Laptop Li-ion battery type TKV2V using an ALT. The developed system can monitor and record battery voltage during its discharge cycle. Based on the experimental results, the probability density function, failure rate and the reliability function under each of the applied loads were evaluated and compared. The results show that increasing the battery load decreases the cycle time significantly and in a geometric progression. The reliability function at each stress level follows almost the same pattern but with differed values. The failure rate increases as stress level increases up to a certain limit then starts to decrease, while the probability density function has the highest value at a stress level 1.48 amp. The battery cycle time was modeled using an inverse power law model that can predict the cycle time at any given stress level considering that the maximum error in prediction is 11.4 % which can be considered as insignificant. Although the presented results show the performance of a specific type of battery; however, the same approach can be conducted for other types of LIB. In principle, this method can be applied to build a model to predict cycle duration for LIB which is a critical criterion for many applications such as in electric vehicles, satellites, and mobile devices.

## REFERENCES

- [1] A. Ulvestad, "A Brief Review of Current Lithium Ion Battery Technology and Potential Solid State Battery Technologies," *arXiv preprint arXiv:1803.04317*, 2018.
- [2] G. Pistoia, *Lithium-ion batteries: advances and applications*. Newnes, 2013.
- [3] S. Cheng, B. Li, Z. Yuan, F. Zhang, and J. Liu, "Development of a lifetime prediction model for lithium thionyl chloride batteries based on

- an accelerated degradation test," *Microelectronics Reliability*, vol. 65, pp. 274-279, 2016.
- [4] W. B. Nelson, *Accelerated testing: statistical models, test plans, and data analysis*. John Wiley & Sons, 2009.
- [5] E. Nogueira, V. Orlando, J. Ochoa, A. Fernandez, and M. Vazquez, "Accelerated Life Test of high luminosity blue LEDs," *Microelectronics Reliability*, vol. 64, pp. 631-634, 2016/09/01/ 2016.
- [6] J. Hao, Y. Rui-Qiang, H.-L. Ke, Q. Sun, and L. jing, "Analysis of the reliability of LED lamps during accelerated thermal aging test by online method," *Optik*, 2018/09/25/ 2018.
- [7] J. Hao, D. Li, C. He, Q. Sun, and H. Ke, "Step-down accelerated aging test for LED lamps based on nelson models," *Optik - International Journal for Light and Electron Optics*, vol. 149, pp. 69-80, 2017/11/01/ 2017.
- [8] M. Sawant and A. Christou, "Failure modes and effects criticality analysis and accelerated life testing of LEDs for medical applications," *Solid-State Electronics*, vol. 78, pp. 39-45, 2012/12/01/ 2012.
- [9] M. Yazdan Mehr, M. R. Toroghinejad, F. Karimzadeh, W. D. van Driel, and G. Q. Zhang, "A review on discoloration and high accelerated testing of optical materials in LED based-products," *Microelectronics Reliability*, vol. 81, pp. 136-142, 2018/02/01/ 2018.
- [10] Y. T. Kim, K.-B. Kim, Y. E. Hyun, I.-J. Kim, and S. Yang, "Simulation study on the lifetime of electrochemical capacitors using the accelerated degradation test under temperature and voltage stresses," *Microelectronics Reliability*, vol. 55, no. 12, Part B, pp. 2712-2720, 2015/12/01/ 2015.
- [11] J. Virkki, T. Seppälä, L. Frisk, and P. Heino, "Accelerated testing for failures of tantalum capacitors," *Microelectronics Reliability*, vol. 50, no. 2, pp. 217-219, 2010/02/01/ 2010.
- [12] J. Kim, D. Yoon, M. Jeon, D. Kang, J. Kim, and H. Lee, "Degradation behaviors and failure analysis of Ni-BaTiO<sub>3</sub> base-metal electrode multilayer ceramic capacitors under highly accelerated life test," *Current Applied Physics*, vol. 10, no. 5, pp. 1297-1301, 2010/09/01/ 2010.
- [13] C. Kalaiselvan and L. B. Rao, "Accelerated life testing of nano ceramic capacitors and capacitor test boards using non-parametric method," *Measurement*, vol. 88, pp. 58-65, 2016/06/01/ 2016.
- [14] W. Gu, Z. Sun, X. Wei, and H. Dai, "A new method of accelerated life testing based on the Grey System Theory for a model-based lithium-ion battery life evaluation system," *Journal of Power Sources*, vol. 267, pp. 366-379, 2014/12/01/ 2014.
- [15] E. Chiodo, D. Lauria, N. Andrenacci, and G. Pede, "Accelerated life tests of complete lithium-ion battery systems for battery life statistics assessment," in *2016 International Symposium on Power Electronics, Electrical Drives, Automation and Motion, SPEEDAM 2016*, 2016.
- [16] K.-J. Chung and C.-C. Hsiao, "Accelerated Degradation Assessment of 18650 Lithium-Ion Batteries," presented at the 2012 International Symposium on Computer, Consumer and Control, 2012.
- [17] E. V. Thomas, H. L. Case, D. H. Doughty, R. G. Jungst, G. Nagasubramanian, and E. P. Roth, "Accelerated power degradation of Li-ion cells," *Journal of Power Sources*, vol. 124, no. 1, pp. 254-260, 2003/10/01/ 2003.
- [18] K. Takei *et al.*, "Cycle life estimation of lithium secondary battery by extrapolation method and accelerated aging test," *Journal of Power Sources*, vol. 97-98, pp. 697-701, 2001/07/01/ 2001.
- [19] M. T. Madi, "Step-Stress Accelerated Life Tests," in *International Encyclopedia of Statistical Science*, M. Lovric, Ed. Berlin, Heidelberg: Springer Berlin Heidelberg, 2011, pp. 1514-1517.
- [20] J. Robinson and W. Nelson, *Accelerated Testing: Statistical Models, Test Plans, and Data Analysis*. 1991, p. 548.
- [21] K. Chung and C. Hsiao, "Accelerated Degradation Assessment of 18650 Lithium-Ion Batteries," in *2012 International Symposium on Computer, Consumer and Control*, 2012, pp. 930-933.
- [22] Paul Wagner, "Techniques to evaluate long term aging of systems," D. G. Paul Lein, David Nicholls, Ed., ed, 2011.
- [23] Q. Sun, H.-N. Dui, and X.-L. Fan, "A statistically consistent fatigue damage model based on Miner's rule," *International Journal of Fatigue*, vol. 69, pp. 16-21, 2014/12/01/ 2014.
- [24] D. Kececioglu and J. A. Jacks, "The Arrhenius, Eyring, inverse power law and combination models in accelerated life testing," *Reliability Engineering*, vol. 8, no. 1, pp. 1-9, 1984/01/01/ 1984.
- [25] L. F. Zhang, M. Xie, and L. C. Tang, "A study of two estimation approaches for parameters of Weibull distribution based on WPP," *Reliability Engineering & System Safety*, vol. 92, no. 3, pp. 360-368, 2007/03/01/ 2007.