

# Monitoring of Belt-Drive Defects Using the Vibration Signals and Simulation Models

A. Nabhan, Mohamed R. El-Sharkawy, A. Rashed

**Abstract**—The main aim of this paper is to dedicate the belt drive system faults like cogs missing, misalignment and belt worm using vibration analysis technique. Experimentally, the belt drive test-rig is equipped to measure vibrations signals under different operating conditions. Finite element 3D model of belt drive system is created and vibration response analyzed using commercial finite element software ABAQUS/CAE. Root mean square (RMS) and Crest Factor will serve as indicators of average amplitude of envelope analysis signals. The vibration signals pattern obtained from the simulation model and experimental data have the same characteristics. It can be concluded that each case of the RMS is more effective in detecting the defect for acceleration response. While Crest Factor parameter has a response with the displacement and velocity of vibration signals. Also it can be noticed that the model has difficulty in completing the solution when the misalignment angle is higher than 1 degree.

**Keywords**—Simulation model, misalignment, cogs missing and vibration analysis.

## I. INTRODUCTION

As engines and vehicles in industrial equipment and appliances become smaller and smaller, the challenge is to transfer power generated without loss of reliability or performance. The most important factor for the immortality of machines is the maintenance of machines to work with maximum safety and reliability. The faults may develop temporarily in the system due to operating conditions such as looseness, heat generation, wear, etc. The failure of the rotor system has safety effects along with economic considerations. Thus, by applying the concept of state-of-the-art monitoring techniques, the machine operation status can be analyzed. Vibration analysis is the most commonly used analysis method to analyze machine operating condition and may provide a clear indication of most machine failures.

Vibration analysis is among the most widely used methods for detecting bearings defects [1]. Faults diagnosis methods for machine components were specialized only by shock pulse and the vibration spectrum analysis methods [2]. The proposed detection technology allows accurate location of the defects as well as its development in the operating state, allowing predictive maintenance tasks. The flexible multi body belt-drive model, different damping mechanisms are proposed for the damping of the longitudinal and bending deformations and several experiments were conducted in order to obtain the damping properties [3]. Good agreement between the numerical result and the experimentally obtained data was found.

A. Nabhan and A. Rashed are with the Production Engineering and Mechanical Design, Faculty of Engineering, Minia University, El-Minia 61111, Egypt (e-mail: a.nabhan@minia.edu.eg).

Belt conveyors are the equipment widely used in coal mines and other manufacturing industries, whose main components are a number of idlers. Performance monitoring of vibration using in belt conveyor system was investigated [4]. The vibration analysis technique is used to find out the different faults that appeared in the operating systems, like belt worm, misalignment and resonance [5]. The belt drive experimental setup was designed, fabricated and used for experimental work to obtain realistic vibration data for different working condition. Three different faults such as side-cut-out, side-cut-in and loose & side-cut-out were created in the belt to study and understand the behavior of the system during healthy and fault running condition. Different faults appear when the pulley-belt system is operating like unbalance, misalignment, belt worm and chirp noise [6]. The results of Fast Fourier Transform FFT explained the effect of each type of faults comparing with the operating condition FFT of the system. A numeric model of the ball bearing is established using ABAQUS to study the effect angular position defect around the outer race. The statistical parameters ratio extracted from simulation through numeric model were used to characteristic the bearing performance [7]. Moreover, the model is developed to detect the number of defects on the outer race of the bearing [8]. A vibration model is established in a scaled model to simulate and monitor system performance in term of vibration signals level in case of balanced and unbalanced rotational conditions. The obtained signals of the vibration sensor is processed and controlled and then plotted using C language [9]. Adding and reducing the mass for balancing can be performed to obtain lower vibration level. The experimental frequency spectra were obtained for both balanced and unbalanced conditions under different unbalanced forces at different speed conditions [10].

The purpose of this study is to examine and better understand the effects of belt drive system faults on the performance of the system under various operating conditions. A three-dimensional model is established to evaluate belt drive damaged, cogs missing, and the belt misalignment with different angles. The model is established to obtain simulated vibration signals using finite element analysis through ABAQUS software. The vibration monitoring methods are examined using, RMS and Crest Factor.

Mohamed R. El-Sharkawy is with the Automotive and Tractors Engineering, Faculty of Engineering, Minia University, El-Minia 61111, Egypt.

## II. EXPERIMENTAL EQUIPMENT

An experimental setup is employed in this research to collect the vibration signals to study the vibration signatures generated by incipient belt drive system defects. Fig. 1 shows a schematic diagram of the testing device and equipment used in data collection. The power unit of the testing rig is a three-phase asynchronous motor with variable speed characteristics up to 6000 rpm. The motor is actuated with the control unit. The control unit contains a frequency converter for continuous adjustment of the speed. An elastic claw coupling is installed to connect the shaft with the electric motors to prevent of the shaft misalignment and to increase the flexibility of the shaft. The arrangement has also two ball bearings, which are fitted into two bearing housings. The accelerometers, used in the test rig, are piezoelectric sensors with integral electronics (IMI Sensors-603C01).

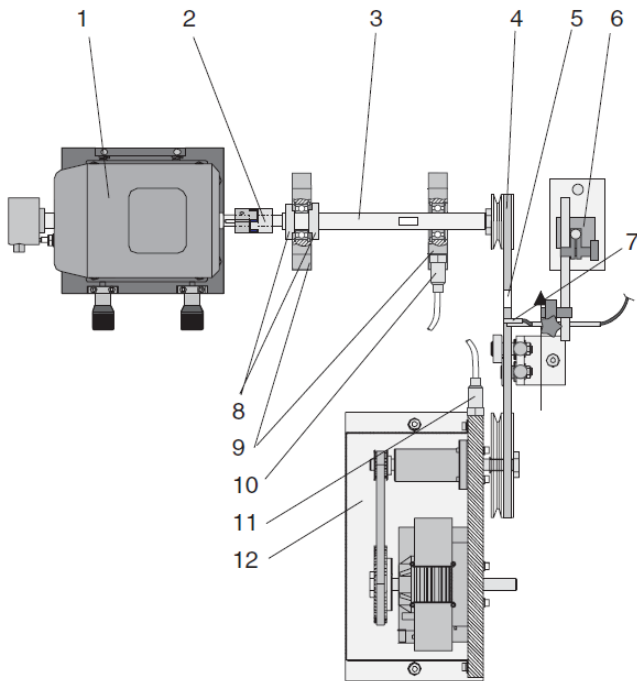

- |                          |                                      |
|--------------------------|--------------------------------------|
| 1 Drive unit             | 2 Elastic claw coupling              |
| 3 Short shaft            | 4 Small belt pulley for V-belt drive |
| 5 Reflective mark        | 6 Magnetic clamp with steel plate    |
| 7 Reference sensor       | 8 Setting rings for axial attachment |
| 9 Bearing block          | 10 Acceleration sensor 1             |
| 11 Acceleration sensor 2 | 12 Brake & Load Unit                 |

Fig. 1 Schematic representation of the test rig

The piezoelectric sensors, with sensitivity of 100 mV/g, convert the measured vibrations into electrical signals. The amplifier supplies the acceleration sensors with current and filter the signals from the accelerometers. The amplifier allows to amplify the signals with gain factor of 1, 10, or 100. The signal is then digitized in the data acquisition card (BMC USB-AD16F) and transferred to the PC, where it is processed. The software allows the signals to be evaluated. For this purpose, the software provides various forms of representation. The

software depends on the reference sensor to measure revolution / min of the shaft. The reference sensor (OZDK 10P5101/S35A) is a reflex photoelectric proximity switch. The drive wheel is to be fitted on a shaft from the base unit. The belt pulleys are assembled using clamping sets. The package also includes a damaged V-belt and an eccentrically bored small belt pulley, as shown in Fig. 2. The large belt pulley should be fitted on the belt pulley bearing block.



Fig. 2 Belt drive with Missing Cogs V-belt

## III. SIMULATION MODEL TECHNIQUE

The Dynamic three-dimensional model was created to study the effect of belt drive defects, Missing Cogs, and pulley misalignment on the vibration signals. The 3D model of belt drive system is designed using commercial software package ABAQUS/CAE. It is assumed that contact between the belt and its mating surface on the pulley means that no relative movement is allowed on the contact surface. Cogged belts are made as flexible belts with teeth molded onto their inner surface. The load of the belt is applied from the cogs to the pulley as frequency load because of the belt geometry and details of the distribution are illustrated in Fig. 3. The belt geometry is partitioned into 16 parts. The contact between the inner surface of the belt and the pulley groove occurs in a rectangular area. Interaction between surfaces are defined as surface-to-surface contact with no adjustment. The lower surface of the race is developed as fixed part which have no degree of freedom, ENCASTRE,  $U_1=U_2=U_3=UR_1=UR_2=UR_3=0$ . For analyzing the geometric contact, 3-D model mesh is developed using hexahedron solid element, which has 8-nodes with fully integrated (C3D8). Fig. 4 illustrate the mesh-seed pattern of belt drive system with the fully integrated, 8-nodes elements (C3D8).

One of the problems facing maintenance operations is the belt noise. Misalignment is the main reason which causes of the belt noise. A belt noise can make chirping or squealing sounds that may be consistent or may intermittent. Failure mode of misalignment of the belt drive system illustrates in Table I. The simulation model is established to study the effect of misalignment angles of the belt drive on the vibration signals.

The misalignment angles of the belt drive which set in this study, is 0.5, 1.0, 1.5, 2.0, 2.5" degrees.

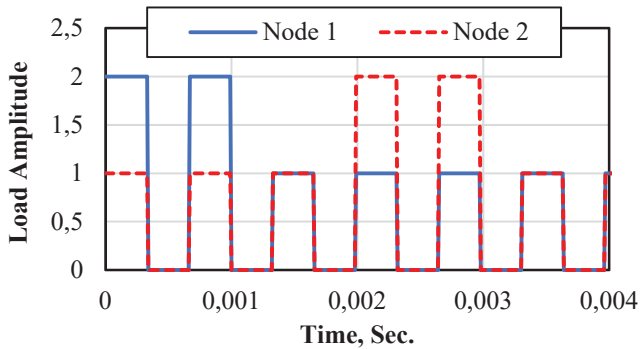

Fig. 3 Dynamic loading models for nodes 1 and 2 acting on a contact area

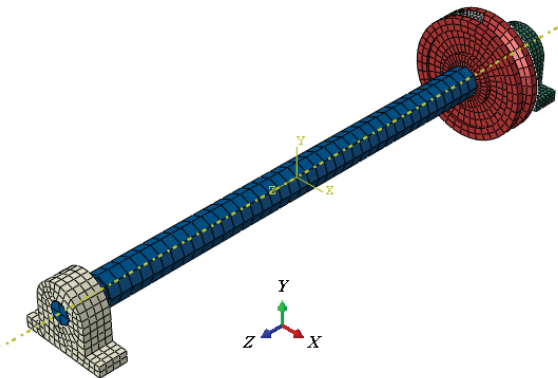

Fig. 4 Mesh-seed pattern of the belt drive system

TABLE I  
 FAILURE MODE OF MISALIGNMENT OF THE BELT DRIVE SYSTEM

Degrees of Misalignment	Failure Mode
0" to 1.0"	Very low potential for chirp noise
1.0 to 1.5"	Potential for chirp noise
1.5" to 2.0"	High probability for chirp noise
> 2.5"	Extreme chirp noise / Probability of belt jump

#### A. Time Domain Techniques

One of the simpler detection and diagnostic approaches is to analyze the measured vibration signal in the time domain. Whilst this can be as simple as visually looking at the vibration signal, other more sophisticated approaches can be used such as trending time domain statistical parameters. A number of statistical parameters can be defined as RMS, peak, and Crest Factor based upon the beta distribution. Time domain statistical parameters have been used as one-off and trend parameters in an attempt to detect the presence of incipient belt damage.

$$RMS = \sqrt{\frac{1}{N} \sum_{i=1}^N [X(t) - \bar{X}]^2}$$

$$Crest\ factor = [max.(X) - min.(X)]/RMS$$

where  $\bar{X}$  : The mean value of the discrete time signal  $X(t)$  and  $N$ : Number of data points.

The vibration data are calculated for points **V** and **H** for a broad range of rotational speed ranging from 1000 to 3000 rpm.

## IV. RESULTS AND DISCUSSION

### A. Vibration Signals Analysis

In this section, the vibration data are analyzed and different techniques such as time domain and envelope analysis are assessed with regard to their effectiveness in the detection of belt drive system defects. Figs. 5 and 6 illustrate the typical waveform of the damaged V-belt drive in time domain and envelope analysis techniques. The vibration data are carried out under a shaft rotational speed of 2500 rpm (41.67 Hz). It can be observed that, the time domain signals display a clear regular waveform with small peak less than 0.5 m/sec<sup>2</sup> in acceleration amplitude. In Fig. 6, the envelope spectrum analysis, the fundamental vibration and harmonics of the belt frequency can clearly be seen (25.6 Hz). Belt frequency can be calculated according the following formula:

$$f_R = n \times U_{AR} / 60 \times L_A$$

where,  $n$ : drive shaft speed in rpm,  $L_R$ : V-belt length,  $U_{AR}$ : Drive roller circumference,  $f_R$ : V-belt frequency in Hz.

The boundary conditions of the simulation process have been chosen to satisfy an acceptable homogeneity between the experimental set up and the simulated model. Align and secure the drive unit and bearing blocks. Fig. 7 shows the corresponding signal that obtained from the simulation process. It is observed from Figs. 5 and 7 that the dynamic response of the belt drive is approximately similar for the experimental and theoretical cases. Furthermore, it is noticed from these results indicated that the proposed method of simulation can be used to produce vibration data for condition monitoring applications.

The analytical results describe the alteration of statistical parameters, RMS and Crest Factor, for acceleration, displacement and velocity responses in both data collection points, vertical [V] and horizontal [H]. The variation of the RMS of the acceleration versus the shaft speed of the belt drive model is shown in Fig. 8. The RMS acceleration response for both the vertical and horizontal directions [V and H] displays for the three coordinates [1, 2, and 3]. It can be seen that acceleration give high result at the vertical direction in the X-coordinate [A1] and the horizontal direction in the Z-coordinate [A3]. The same observation is valid for the displacement and velocity response as shown in Figs. 9 and 10 respectively. It can be concluded that RMS parameters for vertical point in the X-coordinate [A1] and the horizontal pint in the Z-coordinate [A3], seems to be a better receiving point for defect detection. It can be seen form Fig. 11 that the Crest Factor parameter for acceleration response give convergent values for both the vertical and horizontal directions [V and H] displays for the three coordinates [1, 2, and 3]. It can be concluded that Crest Factor parameter for acceleration response give a constant rate and it is difficult to detect a defect. Fig. 12 illustrates the crest factor ratio for displacement response for belt drive model versus the shaft speed. It can be noticed that displacement response gives high result at the vertical data collection point in

X-coordinate [V1] and Z-coordinate [V3]. The same observation is valid for the velocity response the vertical point in Z-coordinate [V3] for as shown in Fig. 13. It can be concluded that the Crest Factor for vertical point, i.e. [V], seems

to be a good receiving point for defect detection in X-coordinate [V1] and Z-coordinate [V3] for displacement response and in Z-coordinate [V3] for velocity response.

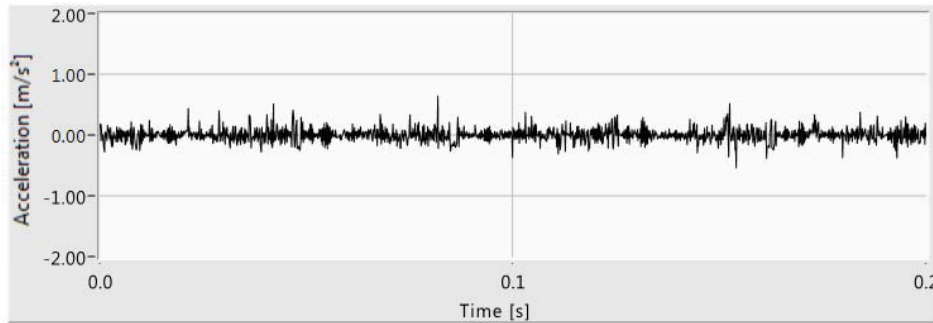

Fig. 5 Vibration acceleration signals with time domain for the damaged V-belt

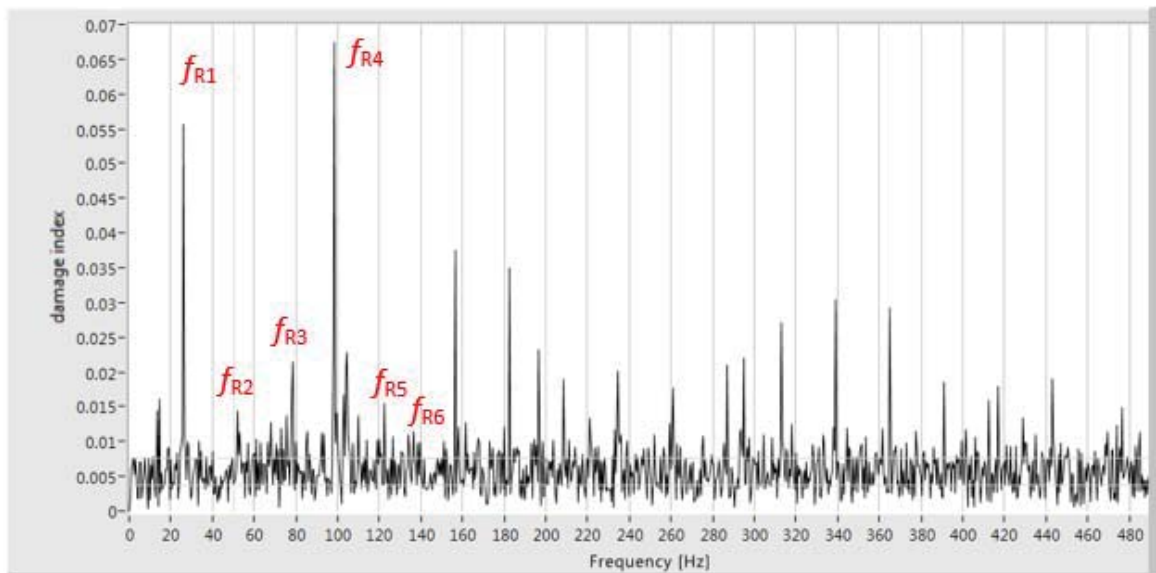

Fig. 6 Vibration acceleration signals with envelope analysis for the damaged V-belt

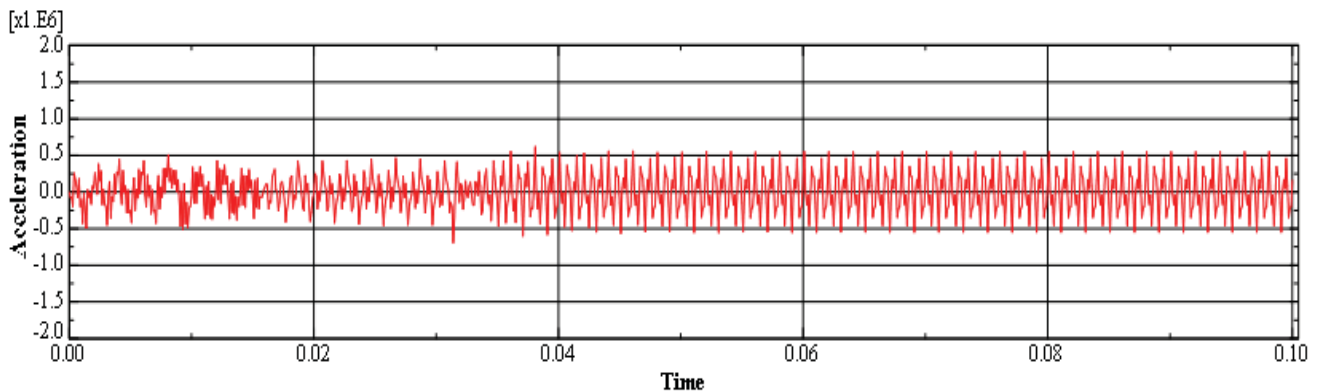

Fig. 7 Simulation acceleration signals with time domain for the damaged V-belt



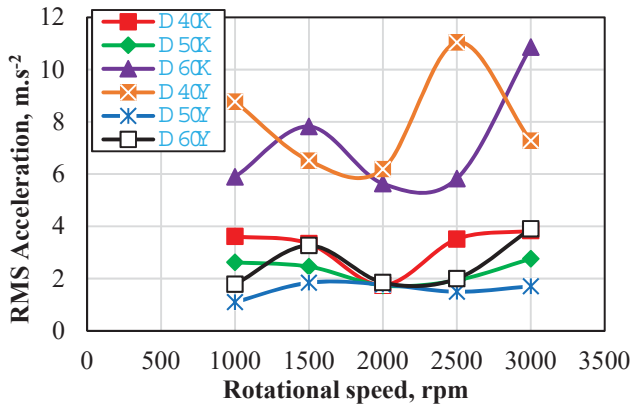

Fig. 8 RMS acceleration response of the damaged V-belt drive for simulation model

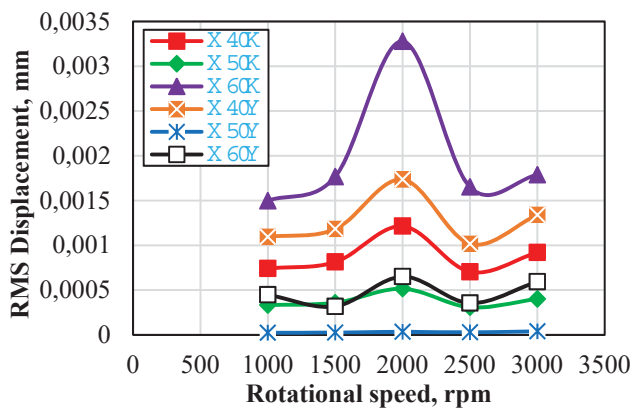

Fig. 9 RMS displacement response of the damaged V-belt drive for simulation model

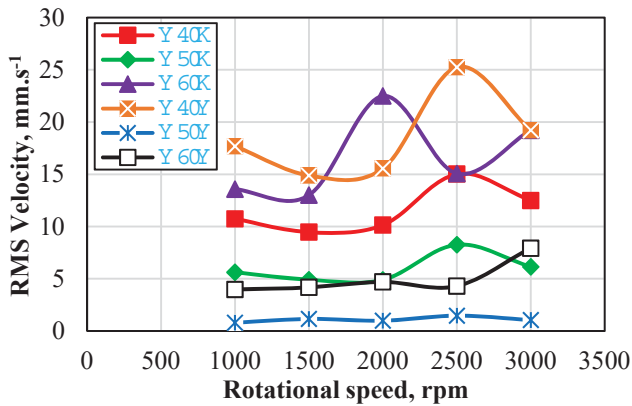

Fig. 10 RMS velocity response of the damaged V-belt drive for simulation model

In this section the misalignment angles of the belt drive is changed from 0.5° to 2.5° with intervals of 0.5°. The different misalignment angles are studied by using the ratios RMS, and Crest Factor. The analytical results describe the alteration of the acceleration, displacement and velocity for vertical and horizontal direction. The RMS acceleration response is displayed for both vertical and horizontal [V and H] for the three coordinates [1, 2, and 3]. It can be seen form Fig. 14 that

the RMS acceleration response gives a high result in the vertical orientation in the coordinate of X [A<sub>1</sub>] and the horizontal orientation in the coordinate of Z [A<sub>3</sub>]. The highest value of the acceleration response can be observed at the misalignment angle of 1.0 degree.

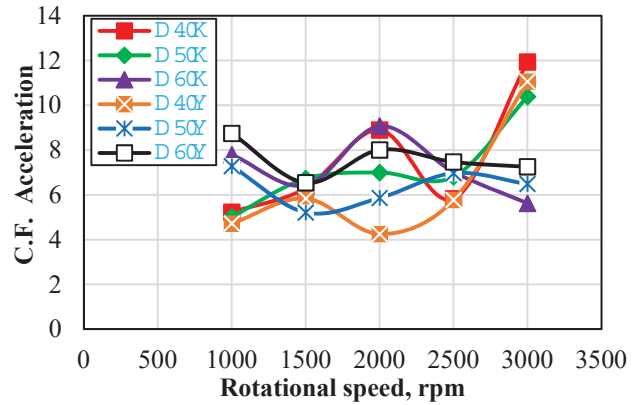

Fig. 11 Crest Factor acceleration of the damaged V-belt drive for simulation model

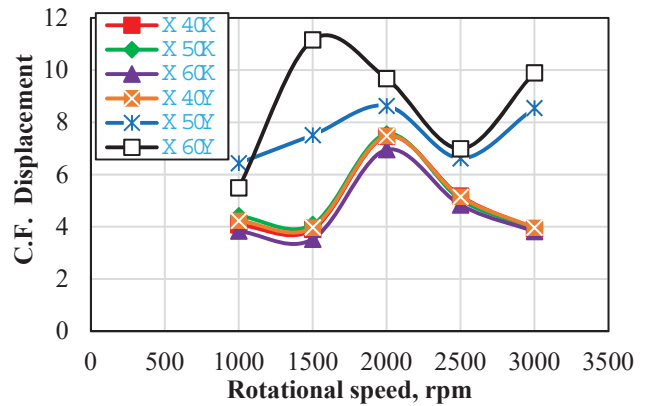

Fig. 12 Crest Factor displacement of the damaged V-belt drive for simulation model

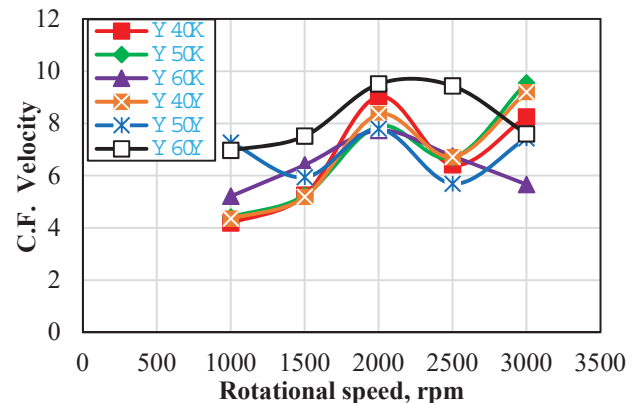

Fig. 13 Crest Factor velocity of the damaged V-belt drive for simulation model

The main observation when running the simulation model is that by increasing the misalignment angle above 1 degree, the

model does not complete the solution. In case the misalignment angle of 1.5 and 2.0 degrees the model the solution is disrupted at the ratio 91% while the misalignment angle of 2.5 degrees the solution is disrupted at the ratio 40%. It may be due to an increase in angle of inclination because the contact surfaces of the belt and the pulley increases the error rates of the elements in the mating areas. It can be concluded that the contact zone elements are distorted by increasing the inclination angle of the belt. The same notice is standing for the displacement and velocity response as shown in Fig. 15 and 16 respectively. It can be inferred that RMS parameters of the vertical point in the X-coordinate [A<sub>1</sub>] and the horizontal pint in the Z-coordinate [A<sub>3</sub>] seem to be a good collecting data point for system monitoring. Fig. 17 can be seen that the Crest Factor parameter for acceleration response have close values for both the vertical and horizontal directions [V and H] displays for the three coordinates [1, 2, and 3]. It can be concluded that Crest Factor parameter for acceleration response gives close average and the defect is difficult to discover. Fig. 18 illustrates the crest factor ratio for displacement response for belt drive model versus the shaft speed. It can be noticed that displacement response gives high result at the vertical data collection point in Y-coordinate [V<sub>2</sub>]. While the velocity response displays high result at the vertical point in Z-coordinate [V<sub>3</sub>] for as shown in Fig. 19. It can be concluded that the Crest Factor for vertical point, i.e. [V], seems to be a good receiving point for defect detection in X-coordinate [V<sub>1</sub>] and Y-coordinate [V<sub>2</sub>] for displacement response and in Z-coordinate [V<sub>3</sub>] for velocity response.

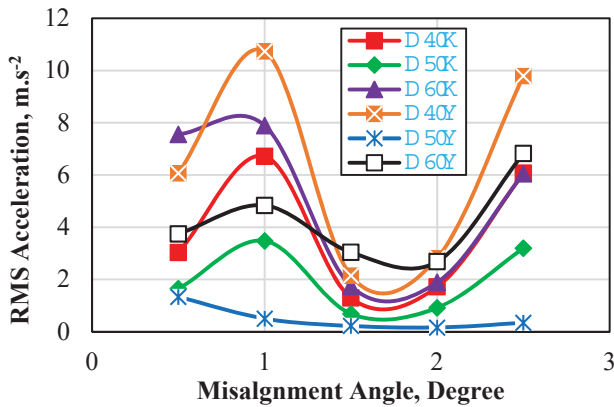

Fig. 14 RMS acceleration response of the belt misalignment for simulation model

**B. Von-Mises Stress Distribution**

In this section, the proposed simulation model allows for the accurate location of the stress concentration areas as well as for the distribution of stresses to the whole part, allowing avoiding the occurrence of catastrophic failure. Fig. 20 displays the Von-Mises stress distribution for whole belt drive model. It can be seen that the maximum stress located at position which the pulley is mounted. Furthermore, the stress distribution on the shaft displays more detailed on Fig. 21. Fig. 22 shows the distribution of the stresses of the housing and it can be noticed that the highest value of the stresses are present at the inner edge of the housing as a result of direct reaction force. The same

notice is standing for the stresses distribution for the pulley as shown in Fig. 23. It is also evident that the value of the stresses concentration of the belt shall be at critical cross section, as illustrate in Fig. 24. It may be used to calculate the belt time life before being cut.

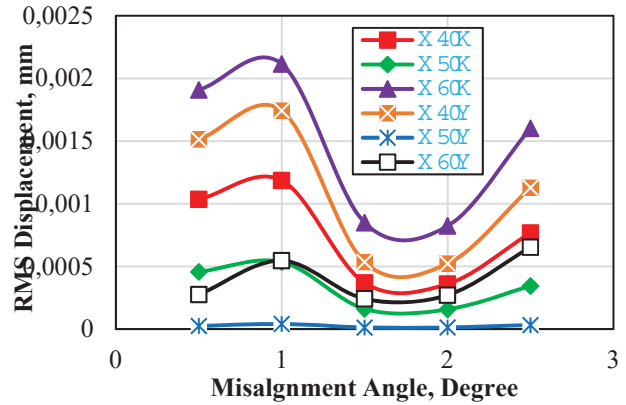

Fig. 15. RMS displacement response of the belt misalignment for simulation model

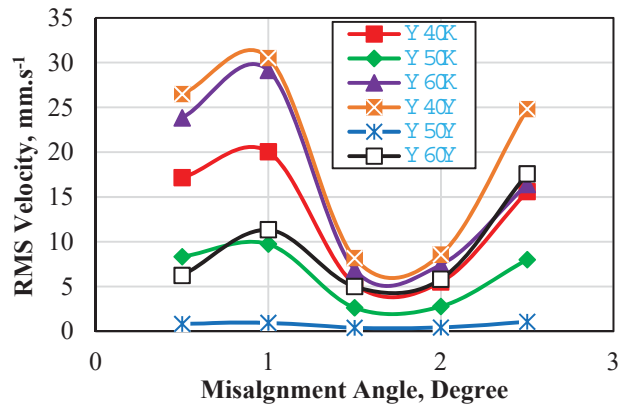

Fig. 16 RMS velocity response of the belt misalignment for simulation model

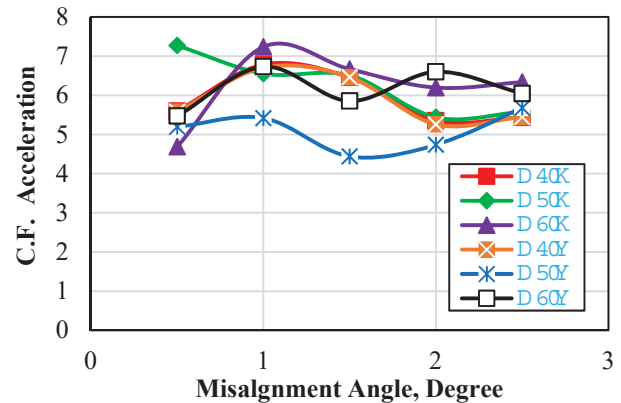

Fig. 17 Crest Factor acceleration of the belt misalignment for simulation model

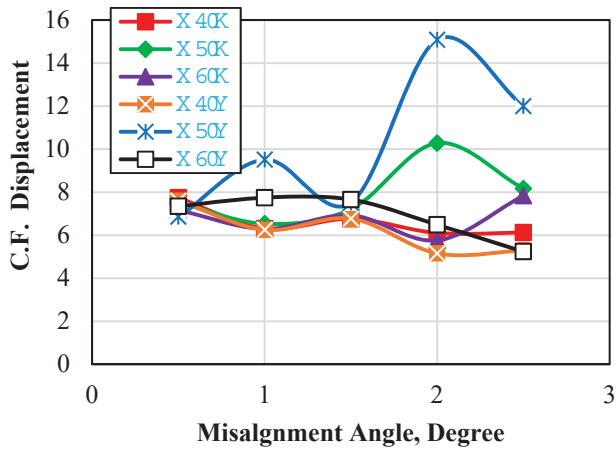

Fig. 18 Crest Factor displacement of the belt misalignment for simulation model

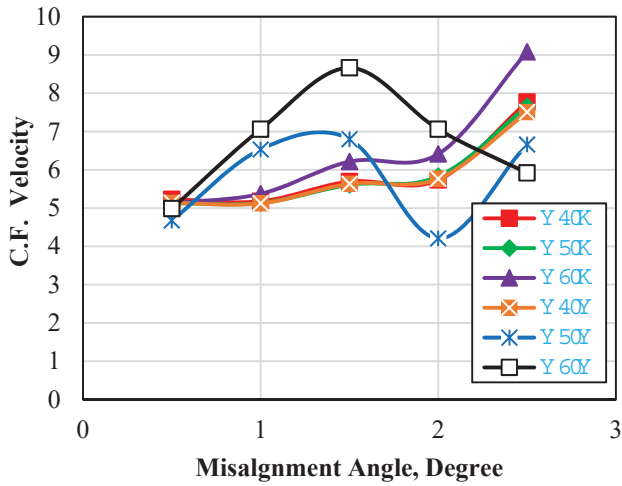

Fig. 19 Crest Factor velocity response of the belt misalignment for simulation model

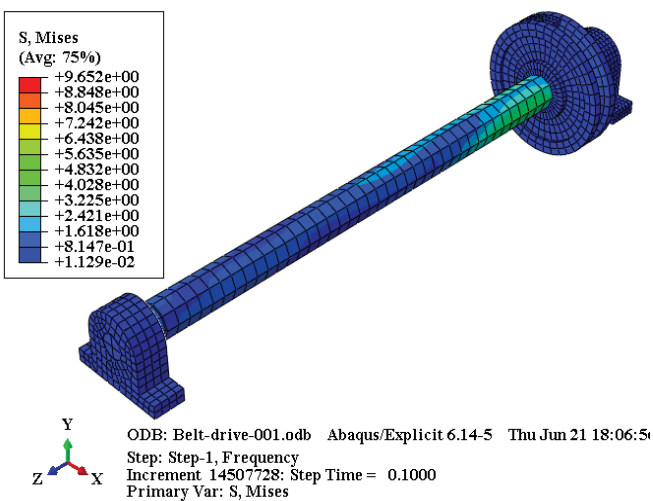

Fig. 20 Von-Mises stress distribution of full belt drive model

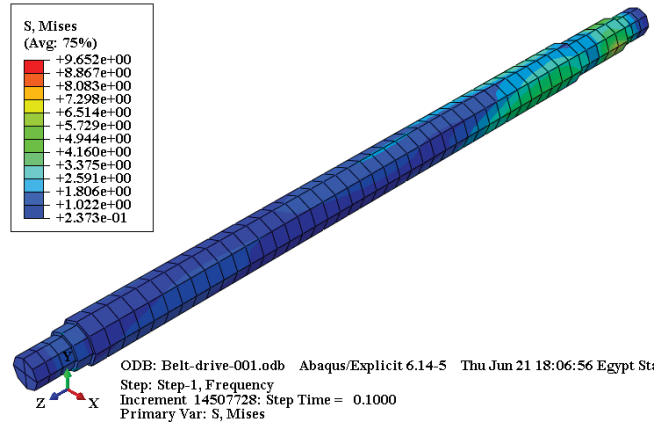

Fig. 21 Von-Mises stress distribution of shaft model

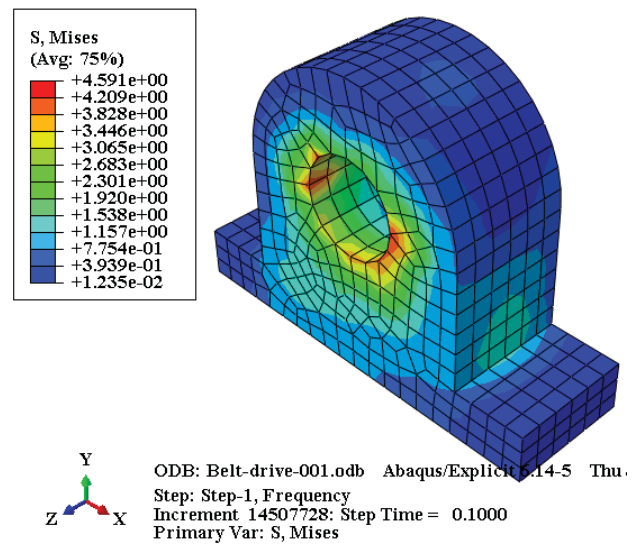

Fig. 22 Von-Mises stress distribution of bearing housing model

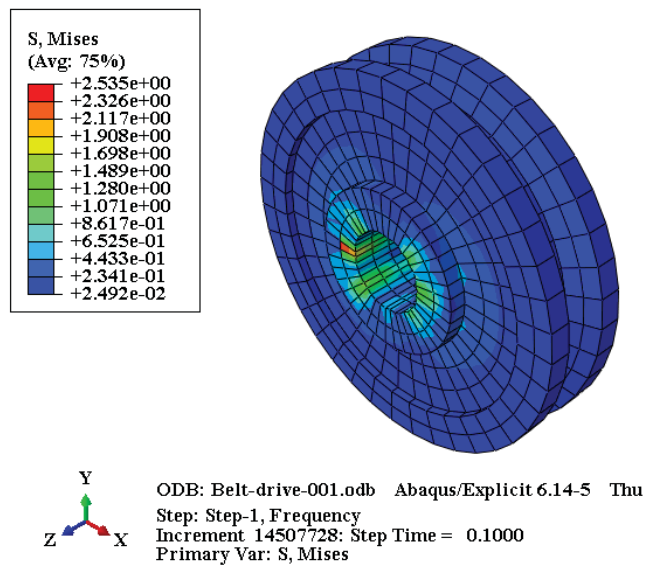

Fig. 23 Von-Mises stress distribution of pulley model

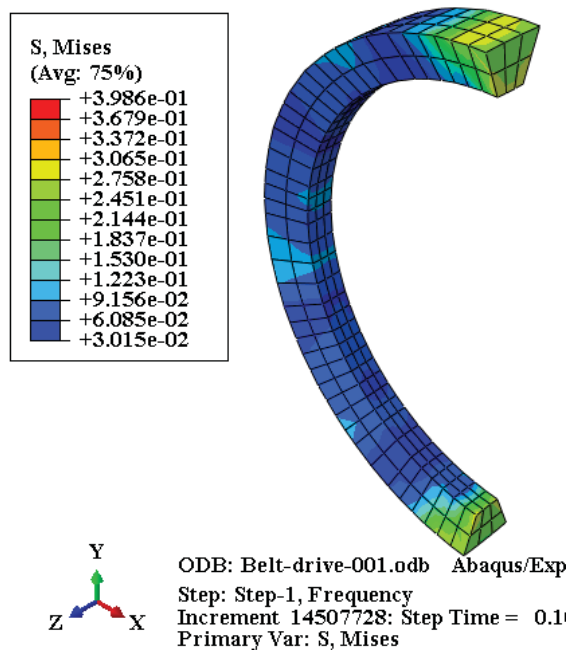

Fig. 24 Von-Mises stress distribution of V-belt model

#### V. CONCLUSION

In this paper, it is concluded that the time domain not suitable to predict the fault. But the frequency domain analysis displays the fault accurately. The dynamic response of the belt drive model is approximately similar for the experimental and theoretical cases. Furthermore, it is noticed from these results indicated that the proposed method of simulation can be used to produce vibration data for condition monitoring applications. A number of statistical parameters can be defined as RMS, peak, and Crest Factor. It can be concluded that RMS parameters for vertical point in the X-coordinate [A<sub>1</sub>] and the horizontal pint in the Z-coordinate [A<sub>3</sub>], seems to be a better receiving point for defect detection. While the Crest Factor for vertical point, i.e. [V], seems to be a good receiving point for defect detection in X-coordinate [V<sub>1</sub>] and Z-coordinate [V<sub>3</sub>] for displacement response and in Z-coordinate [V<sub>3</sub>] for velocity response. . The simulation model is established to study the effect of misalignment angles of the belt drive on the vibration signals. The misalignment angles of the belt drive which set in this study, is 0.5, 1.0, 1.5, 2.0, 2.5° degrees. It is possible to note that the model cannot complete the solution when the misalignment angle increases above 1 degree. In case the misalignment angle of 1.5 and 2.0 degrees the model the solution is disrupted at the ratio 91% while the misalignment angle of 2.5 degrees the solution is disrupted at the ratio 40%. It may be due to an increase in angle of inclination because the contact surfaces of the belt and the pulley increases the error rates of the elements in the mating areas. Moreover, Simulation model allows for the accurate location of the stress concentration areas as well as for the distribution of stresses to the whole part, allowing avoiding the occurrence of catastrophic failure.

#### REFERENCES

- [1] Tandon, N., and A. Choudhury. "A review of vibration and acoustic measurement methods for the detection of defects in rolling element bearings." *Tribology International* Vol.32.8, p.p. 469-480, 1999.
- [2] Dimitris C. Tsantiotis, Theodore N. Costopoulos, and Ioannis S. Zotos, "Maintenance of Mechanical Drivers and Fault Diagnosis of Machine Elements", 2nd International Conference "From Scientific Computing to Computational Engineering", 2nd IC-SCCE Athens, pp. 5-8, 2006.
- [3] Gregor Cepon, Lionel Manin, MihaBoltezara, "Introduction of damping into the flexible multi- body belt-drive model: A numerical and experimental investigation ", *Journal of Sound and Vibration* 324, pp.283–296, 2009.
- [4] Ojha S., Sarangi D., Pal B.K., Biswal B.B.," Performance Monitoring of Vibration in Belt Conveyor System", *Journal of Engineering Research and Applications*, Vol. 4, Issue 7, pp.22-31, 2014.
- [5] Al Bulushi Abdulrahman Abdulshakoor, M. Lokesha G.R. Rameshkumar,"Fault Diagnosis in Belts using Time and Frequency based Signal Processing Techniques" *International Journal of Recent advances in Mechanical Engineering*, Vol.6, No.11, pp.11-20, 2015.
- [6] Ali Raad Hassan, Khalid Mohsen Ali, "Dignosis of Pulley-Belt System Faults Using Vibration Analysis Technique", *Journal of University of Babylon, Engineering Sciences*, Vol.(26), No.(2), pp.167-180, 2018.
- [7] Nabhan A., Nouby M., Samy A. M., Mousa, M.O.," Vibration analysis of deep groove ball bearing with outer race defect using ABAQUS " *Journal of Low Frequency Noise, Vibration and Active Control*, Vol. 35(4). pp. 312-325, 2016.
- [8] Nabhan A., Nouby M., Samy A. M., Mousa, M.O.," Multiple Defects Detection in Outer Race of Gearbox Ball Bearing Using Time Domain Statistical Parameters" *International Journal of Vehicle Structures & Systems*, Vol. 8(3). pp. 167-174, 2016.
- [9] Djajadi Arko, Arsi Azavi, Rusyadi Rusman, Sinaga Erikson, "Monitoring Vibration of A Model of Rotating Machine", *Journal of Mechatronics, Electrical Power, and Vehicular Technology*, Vol. 2, No 1, pp. 51-56, 2011.
- [10] Kumar B. Kiran, G. Diwakar, Satynarayana Dr. M. R. S. ," Determination of Unbalance in Rotating Machine Using Vibration Signature Analysis", *International Journal of Modern Engineering Research*, Vol.2, Issue.5, pp-3415-3421, 2012.