

Simulation of Concrete Wall Subjected to Airblast by Developing an Elastoplastic Spring Model in Modelica Modelling Language

Leo Laine, Morgan Johansson

Abstract—To meet the civilizations future needs for safe living and low environmental footprint, the engineers designing the complex systems of tomorrow will need efficient ways to model and optimize these systems for their intended purpose. For example, a civil defence shelter and its subsystem components needs to withstand, e.g. airblast and ground shock from decided design level explosion which detonates with a certain distance from the structure. In addition, the complex civil defence shelter needs to have functioning air filter systems to protect from toxic gases and provide clean air, clean water, heat, and electricity needs to also be available through shock and vibration safe fixtures and connections. Similar complex building systems can be found in any concentrated living or office area. In this paper, the authors use a multidomain modelling language called Modelica to model a concrete wall as a single degree of freedom (SDOF) system with elastoplastic properties with the implemented option of plastic hardening. The elastoplastic model was developed and implemented in the open source tool OpenModelica. The simulation model was tested on the case with a transient equivalent reflected pressure time history representing an airblast from 100 kg TNT detonating 15 meters from the wall. The concrete wall is approximately regarded as a concrete strip of 1.0 m width. This load represents a realistic threat on any building in a city like area. The OpenModelica model results were compared with an Excel implementation of a SDOF model with an elastic-plastic spring using simple fixed timestep central difference solver. The structural displacement results agreed very well with each other when it comes to plastic displacement magnitude, elastic oscillation displacement, and response times.

Keywords—Airblast from explosives, elastoplastic spring model, Modelica modelling language, SDOF, structural response of concrete structure.

I. INTRODUCTION

THE Swedish Civil Contingencies Agency (MSB) are among all responsible for the physical protection of the Swedish population, e.g. civil defence shelters. This imposes high demands on knowledge and understanding of the effects of extraordinary events such as loads from explosions. To acquire, preserve and develop such knowledge, it is necessary to study both the load and the structural dynamic response in various amount of detail. For this purpose, since the mid-1990s, MSB has had a long-term research plan to better understand and develop computational and analytical tools for

this purpose. So far this has resulted in four PhD theses and numerous reports and scientific papers, see [6]-[17], and can be downloaded from [22].

Today's buildings have complex subsystems that need to co-exist: e.g. electrical, air conditioning and water systems; some of these system components might also need to be able to withstand impulse loading while mounted on the structure. In industries, avionics, aerospace and naval ships, especially designed for operating in harsh conditions and military usage, are examples where the technology of optimizing the uptime of the complete system has come far. Therefore, a unified object-oriented language for Systems Modeling like Modelica [18] is of high interest for modelling systems with different physical domains at the same time.

In this paper, the SDOF model representing a concrete wall is implemented both Excel and Modelica with elastoplastic properties. The Modelica implementation has both damping and plastic hardening as an option. The results of the two implementations are also compared for a specific case study. Modelica is not a tool but a modelling language which can be used to model and combine electrical, mechanical, thermodynamic, fluid, hydraulic, biological, magnetic, control, event, and real-time, systems, etc. The authors have used the open source tool OpenModelica [19] which includes public libraries of components within the mentioned multidomain. Here, the translational mechanical library has been extended with developing an elastoplastic spring damper with plastic hardening model component that can be used with other components in OpenModelica library for translational mechanics. The model includes equations for defining decomposition of elastic and plastic deformation, using constitutive equation for force, using yield condition, hardening rule, and flow rule from elastoplastic theory. All equations have been written in Modelica's acasual format which means the model can be re-used in diverse ways in a system, i.e. the input and output is not fixed only the equations are formulated in the model.

The paper is organized in the following sections: section II describes how the SDOF is numerically solved when implemented in Excel. Section III describes how the elastoplastic spring damper model was implemented in the mechanical 1-D translational library. Section IV discusses how to derive SDOF parameters, such as mass, elastic stiffness, and plasticity from a physical concrete wall. In section V, the case study is shortly described including the explosion load. In Section VI, the simulated displacement

Leo Laine is with the LL Engineering AB, Stugvägen 4, 438 94 HÄRRYDA, Sweden (phone: +46 70 201 55 80; e-mail: leo.laine@telia.com).

Morgan Johansson is with Norconsult AB and with Chalmers University of Technology as Adjunct Professor, Norconsult AB, Therese Svenssons gata 11, 417 55, Göteborg (e-mail: morgan.johansson@norconsult.com).

results from excel implementation of SDOF is compared with OpenModelica. In Section VII, the paper is concluded and discussed.

II. SDOF SYSTEM

When studying dynamically loaded structures, it is often convenient to use a simple calculation model to capture the essential response obtained. A SDOF system, consisting of the mass, structural properties and acting load, is the simplest way to do so. Below the basic information of the build-up of such a system, and how it can be used, is briefly described. More detailed information can be found in [2] and [12].

For a SDOF system, the basic dynamic equation can be expressed as

$$m\ddot{u} + c\dot{u} + ku = F(t) \quad (9)$$

where m , c , k and F corresponds to the mass, damping, stiffness and acting load, and \ddot{u} , \dot{u} and u are the acceleration, velocity and displacement. For a system subjected to an impulse load, the damping usually has a small effect and here it has been conservatively omitted, resulting in a more simplified system as shown in Fig. 1.

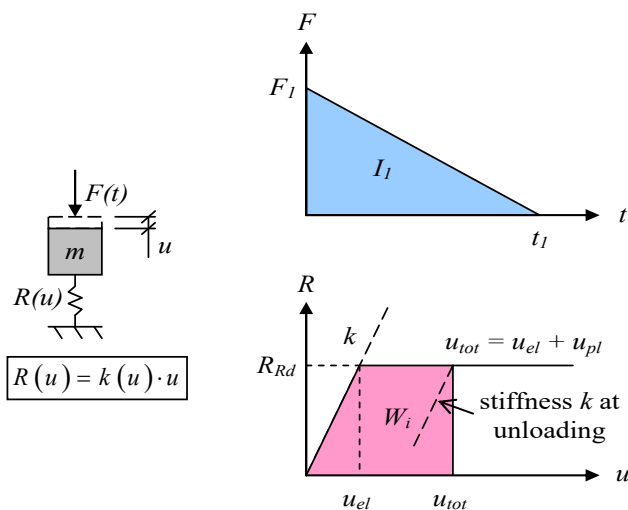

Fig. 1 Simplified SDOF system used with schematic illustration of load relation $F(t)$ and elastoplastic structural response $R(u)$

Depending on the properties used for the load and stiffness, it is possible to analytically solve the displacement u for a given case. However, considering the possibility of a nonlinear structural response $R(u) = k(u) \cdot u$ and complex load properties $F(t)$, it is often convenient to use a numerical solution to determine the resulting displacement $u(t)$. There are several different solution methods available for this, but here the Central Difference Method (CDM) is used, see e.g. [1] or [8].

CDM is a so called explicit solution method, meaning that the solution of the displacement at time $t+\Delta t$, here denoted as ${}^{t+\Delta t}u$, is calculated based solely on equilibrium at time t . Accordingly, all information needed to proceed the solution at

time $t+\Delta t$ is already known and there is no need of any iterations to find a solution in case of a nonlinear response $R(u)$.

Using CDM, and neglecting the effect of damping, the displacement at time $t+\Delta t$ can be determined as

$${}^{t+\Delta t}u = \Delta t^2 {}^t m^{-1} \left({}^t F - \left[{}^t k - \frac{2 {}^t m}{\Delta t^2} \right] {}^t u - \left[\frac{{}^t m}{\Delta t^2} \right] {}^{t-\Delta t} u \right) \quad (2)$$

where Δt is the time step used and index t and $t-\Delta t$ indicate information at time t and time $t-\Delta t$, respectively. Further, a start condition for the displacement at time $-\Delta t$ need to be used; this is expressed as:

$${}^{-\Delta t} u = {}^0 u - \Delta t {}^0 \dot{u} + \frac{\Delta t^2}{2} {}^0 \ddot{u} \quad (3)$$

The expression for the displacement in (2) can easily be programmed in e.g. Excel (used here) or MATLAB and a numerical solution $u(t)$ can be determined. Based on this, the corresponding velocity and acceleration can be determined as

$${}^t \dot{u} = \frac{1}{2\Delta t} ({}^{t+\Delta t} u - {}^{t-\Delta t} u) \quad (4)$$

$${}^t \ddot{u} = \frac{1}{\Delta t^2} ({}^{t+\Delta t} u - 2 {}^t u + {}^{t-\Delta t} u) \quad (5)$$

Using an explicit method can metaphorically be described as driving a car forward, only looking in the back mirror; i.e. one is not able to drive too fast or one will lose control. Practically, this means that there is a time step condition in explicit methods that needs to be fulfilled to get a stable solution. For CDM this means that

$$\Delta t < \Delta t_{cr} = \frac{2}{\omega} = 2 \sqrt{\frac{m}{k}} \quad (6)$$

However, there may also be other reasons to choose a small time step, e.g. small load duration. Hence, using an explicit method is usually a good choice when studying the structural response due to an impulse load since such loads nevertheless demand a small time step to get an accurate solution. The suitable time step in each situation depends on both the load case and the structural dynamical properties. It usually works well to use a time step in the order of 1/100 of the duration of the impulse load; i.e.

$$\Delta t \leq \begin{cases} \Delta t_{cr} \\ 0.01 \cdot t_1 \end{cases} \quad (7)$$

Since no iterations are needed in the solution method the CDM is very suitable to solve nonlinear problems. The expression in (2) can be determined regardless of whether the structural response is linear or not. The trick is to let the

stiffness ${}^t k$ correspond to the secant stiffness to the solution at time t , see Fig. 2 (a). To model an elastoplastic response, as indicated in Fig. 1, it is also important to correctly take into account the effect of unloading, as schematically shown in Fig. 2 (b). If this is not considered the response will be nonlinear elastic; i.e. the response will just follow $R(u)$, not considering any effects of unloading and reloading.

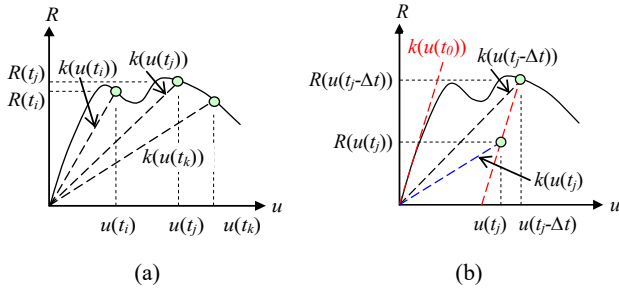

Fig. 2 (a) Secant stiffness used in a general case; (b) considering the effect of unloading when deciding the secant stiffness. Based on [8]

In the calculations carried out here, the following method has been used to include the plastic response:

$${}^t u_{\max} = \max({}^0 u_{\max}, {}^{\Delta t} u_{\max}, \dots, {}^{t-\Delta t} u_{\max}) \quad (8)$$

$${}^t \Delta u_{pl} = \begin{cases} {}^t u - \max(u_{el}, {}^t u_{\max}) & \text{if } {}^t u > u_{el} \text{ and } {}^t u > u_{\max} \\ 0 & \text{if not} \end{cases} \quad (9)$$

$${}^t u_{pl} = \sum_{i=0}^{i=t} {}^i \Delta u_{pl} \quad (10)$$

From this the corresponding internal force, R is then determined in each time step as

$${}^t R = {}^0 k ({}^t u - {}^t u_{pl}) \quad (11)$$

This method is rather primitive but works fine for a simple case like this.

III. MODELLING OF ELASTOPLASTIC SPRING MODEL IN OPEN-MODELICA

The OpenModelica [19] includes many open source libraries such as, electrical, thermal, fluid, magnetic, media, and mechanics. The mechanics library is split into 1-D translational, rotational, and multibody system library. Here, 1-D translational library was used to implement an elastoplastic 1-D spring model. This model includes plastic hardening and damping force which is not included in Section II.

The reader will notice that the format of the equations in this section differs from that used in Section II; equations shown in this section use the Modelica language code format. This is intentional, to increase ease of use if implementing the same equations into Modelica. The following governing

equations were implemented. The first equation is defining the deformation between the two connectors of 1-D spring model by using the relative distance definition s_{rel}

$$deform = s_{rel} - s_{rel0} \quad (12)$$

where s_{rel0} is the initial deformation. Then the deformation is separated into elastic and a plastic part

$$deform = deform_{elastic} + deform_{plastic_1} \quad (13)$$

Thereafter the constitutive equation can be defined as

$$der(force) = ElasticModule * (der(deform) - der(deform_{plastic_1})) \quad (14)$$

where $der(\cdot)$ is the time derivative operator in Modelica language. The yield force is calculated as

$$yieldforce = ElasticModule * s_{elas}; \quad (15)$$

The yield condition is defined as

$$f_Yielding = yieldforce - sign(force) * s_{plastichardening}; \quad (16)$$

Check if the yield condition is met by using equation:

$$f_YieldCondition = abs(force) - abs(f_Yielding); \quad (17)$$

where $f_YieldCondition < 0$ means elastic phase and $f_YieldCondition = 0$ means yielding. The $abs(\cdot)$ is the operator for absolute value.

The hardening rule can be defined by

$$der(s_{plastichardening}) = h_hardeningmodule * der(deform_{plastic_1}); \quad (18)$$

A trial force is calculated as

$$der(forcetriall) = der(deform) * ElasticModule; \quad (19)$$

The force condition is defined as

$$forceCondition = sign(force) * der(forcetriall); \quad (20)$$

Now the flow rule can be defined with the following conditions

$$der(deform_{plastic_2}) = \text{if } f_YieldCondition \geq 0 \text{ and } forceCondition > 0 \text{ then } 1 / (ElasticModule + h_hardeningmodule) * sign(force) * der(forcetriall) \text{ else if } f_YieldCondition \geq 0 \text{ and } forceCondition < 0 \text{ then } 0 \text{ else } 0; \quad (21)$$

Update the plastic deformation derivative

$$\text{der}(\text{deform_plastic_1}) = \text{der}(\text{deform_plastic_2}) \cdot \text{sign}(\text{force}); \quad (22)$$

Damping is defined with the following straight forward equation

$$f_d = d \cdot v_rel; \quad (23)$$

where d is the damping and v_rel is the relative speed between the two connectors in 1-D translational spring model.

Finally, the spring force can be calculated with:

$$f = \text{force} + f_d; \quad (24)$$

The following real parameters were defined: *ElasticModule*, *h_hardeningmodule*, *d*, *s_rel0*, and *s_elas*. Following were defined as protected real states: *s_plastichardening*, *f_d*, *deform*, *deform_plastic_1*, *deform_plastic_2*, *f_YieldCondition*, *f_Yielding*, *yieldforce*, *forcetrial*, *force*, and *forceCondition*. The continuum mechanics of plasticity for one dimension is for example explained in [20].

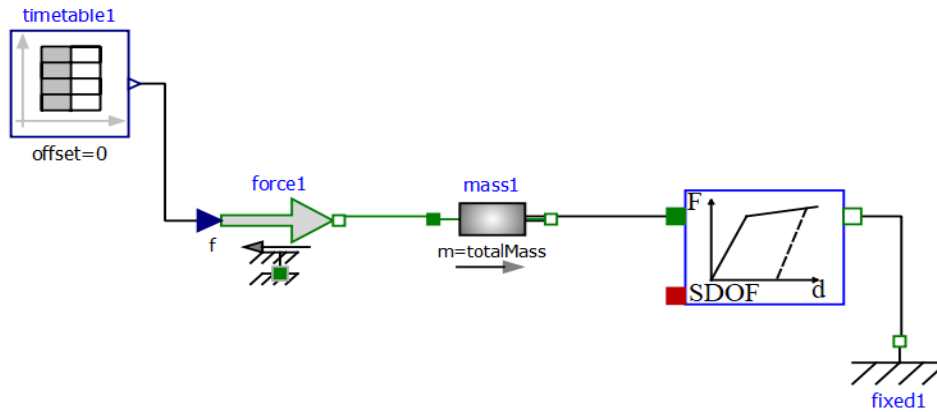

Fig. 3 System model within OpenModelica 1-D translational mechanical library. Including SDOF model of 1-D elastoplastic spring model.

The system model in OpenModelica is shown in Fig. 3. It shows that the loadcase of the airblast on the wall is translated to a time force vector implemented into timetable1, which is the input for the force1 block. The force1 block is mechanically connected to the mass1 block, which represents the SDOF mass of the studied wall. The mass1 block is connected to the SDOF model 1-D elastoplastic spring model. The SDOF model is then finally connected to a fix1 block.

All standard Ordinary Differential Equations (ODE) solvers, e.g. euler, rungekutta, trapezoidal, are available in OpenModelica. However, the powerful solver A Differential/Algebraic System Solver (DASSL) is the one that makes it easy to solve real life physical problems which usually includes Differential Algebraic Equations (DAE) in addition to ODE and solves these systems quite easily [21]. The principle of DASSL solver is to approximate derivatives with k^{th} order Backward Differentiation Formula (BDF). In every step, the DASSL solver chooses the k value and time step Δt based on the behavior of the solution, see [21] for details.

IV. TRANSFORMING A STRUCTURE INTO A SDOF SYSTEM

To use a SDOF system to describe the response of a real structure, the properties of the latter must first be transformed. This can be done using so called transformation factors, relating the property in the SDOF system to that of the structure. This can be done by setting

$$m = \kappa_m m_b \quad (25)$$

$$k = \kappa_k k_b \quad (26)$$

$$F = \kappa_F F_b \quad (27)$$

where index b indicates the property of the structure and κ_m , κ_k and κ_F represent the transformations factor for the mass, stiffness and acting load. Implementing these into (1) and making use of $\kappa_k = \kappa_F$ [2] the basic dynamic equation for a structure can be expressed as

$$\kappa_{mF} m_b \ddot{u} + k_b u = F_b(t) \quad (28)$$

where

$$\kappa_{mF} = \frac{\kappa_m}{\kappa_F} \quad (29)$$

Consequently, the SDOF system used for an arbitrary structure can be defined based on its real stiffness k_b and acting load F_b , while the mass used must be expressed as an effective mass $m = \kappa_{mF} m_b$.

The values of the transformations factors (κ_m), internal work (κ_k) and external work (κ_F) as described in e.g. [2] or [12]. In the literature, values of transformation factors for various basic cases are available, see e.g. [5] or [12]. The deformed shape of the structure is of importance and often linear elastic or plastic response is assumed when determining the value of

κ , see Fig. 4 for schematic illustration of deformed shapes when assuming elastic and plastic response.

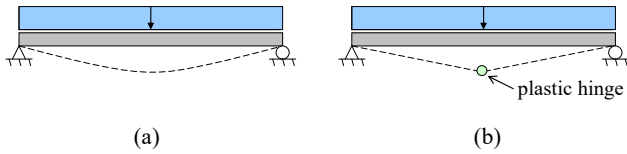

Fig. 4 Illustration of deformed shape in simply supported beam subjected to an evenly distributed load at linear elastic (a) or plastic (b) response

A single point is chosen to represent the response of the structure, here denoted as the system point, and all values related to the structure is related to this point. In Fig. 5, transformation factors κ are summarized for some common cases of a beam subjected to an evenly distributed load.

Evenly distributed load				
Deformed shape, elastic response				
κ_m	0.504	0.406	0.483	0.257
κ_F	0.640	0.533	0.600	0.400
κ_{mF}	0.787	0.762	0.805	0.642
Deformed shape, plastic response				
κ_m	0.333	0.333	0.333	0.333
κ_F	0.500	0.500	0.500	0.500
κ_{mF}	0.667	0.667	0.667	0.667

Fig. 5 Transformation factors κ for beams of various boundary conditions subjected to an evenly distributed load. The black dot indicates the position of the system point. Based on [12]

V. CASE STUDY: RC WALL SUBJECTED TO EXPLOSION LOAD

For the sake of the comparison made in this paper an explosion load acting on a simply supported reinforced concrete wall, spanning in one direction, will be used. The explosion load is based on the reflected pressure caused by a hemispherical charge of 100 kg TNT detonating 15 m from the wall. According to ConWep [4] this approximately corresponds to a peak pressure of $P_r^+ = 300$ kPa and an impulse intensity of $i_r^+ = 960$ Pas. Approximating the $P(t)$ relation to a triangular load shape the corresponding duration can be determined as

$$t_{r,\Delta}^+ = \frac{2 \cdot i_r^+}{P_r^+} = \frac{2 \cdot 960}{300} = 6.4 \text{ ms} \quad (30)$$

The loaded wall is assumed to have geometry, boundary conditions and reinforcement amount according to Fig. 6 (a 1.0 m wide strip is studied), and the load is assumed to be evenly distributed over its length. Material properties are based on Eurocode 2 [3] and is made up of concrete quality C 30 and reinforcement of type B500C; static design material properties are listed in Fig. 6. To simplify, no strain rate

effects are taken into account in the calculations.

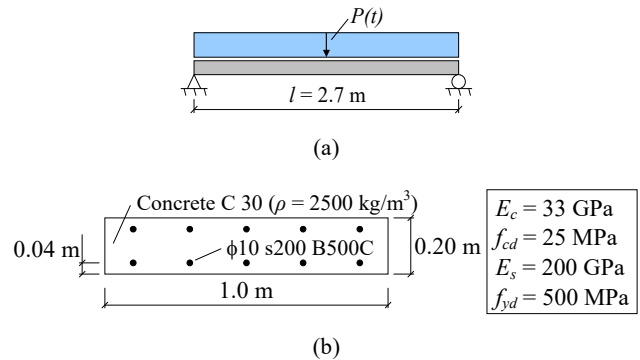

Fig. 6 Studied wall strip subjected to explosion load, (a) showing boundary conditions and (b) showing the cross-section

The calculation of the wall's structural response is based on a SDOF system, as schematically shown in Fig. 1. This means that the response of the wall strip is simulated using one degree of freedom only to describe its full response. This is possible for a case where the shape of the structure's deformation is known (or can be assumed with realistic reliability) throughout its full movement. Here it is assumed that a plastic response will be dominant, i.e. that a plastic hinge forms in the middle of the span as illustrated in Fig. 4.

The total mass of the wall can be determined as

$$m_b = \rho \cdot b \cdot h \cdot l = 2500 \cdot 1.0 \cdot 0.20 \cdot 2.7 = 1350 \text{ kg} \quad (31)$$

and using $\kappa_{mF} = 0.667$ from Fig. 5 the effective mass can be determined as

$$m = \kappa_{mF} \cdot m_b = 0.667 \cdot 1350 = 900 \text{ kg} \quad (32)$$

The stiffness of a simply supported beam subjected to an evenly distributed load can be determined as

$$k = \frac{384}{5} \cdot \frac{EI}{l^3} \quad (33)$$

Here, the moment of inertia is based on a cracked beam (state II) and can thus be determined as

$$I = I_{II} = \frac{bx_{II}^3}{3} + \alpha A_s (d - x_{II})^2 \quad (34)$$

where b is the strip width, x_{II} is the height of the compressive zone, $\alpha = E_s / E_c$ is a material stiffness factor, A_s is the reinforcement amount and d is the effective height.

For a case of pure bending (i.e. no normal force, $N = 0$) the height of the compressive zone can be determined from

$$x_{II} = \frac{bx_{II}^2/2 + \alpha A_s d}{bx_{II} + \alpha A_s} \rightarrow x_{II}^2 + \frac{2\alpha A_s}{b}(x_{II} - d) = 0 \quad (35)$$

Here $\alpha = 6.1$, $A_s = 393 \text{ mm}^2$, $b = 1000 \text{ mm}$ and $d = 160 \text{ mm}$, resulting in $x_{II} = 25 \text{ mm}$, $I_{II} = 4.9 \cdot 10^7 \text{ mm}^4$ and finally a cracked stiffness of $k = k_{II} = 6.3 \cdot 10^6 \text{ N/m}$.

The moment capacity is determined based on stress block factors and cross section force and moment equilibrium as schematically shown in Fig. 7.

The height of the compressive zone is determined as

$$x = \frac{f_{yd} A_s}{0.8 f_{cd} b} = \frac{500 \cdot 393}{0.8 \cdot 25 \cdot 1000} = 25 \text{ mm} \quad (36)$$

and the moment capacity as

$$M_{rd} = f_{yd} A_s (d - 0.4x) = \dots = 30.5 \text{ kNm} \quad (37)$$

From this the static load capacity is determined as

$$R_{Rd} = \frac{8M_{rd}}{l} = \frac{8 \cdot 30.5}{2.7} = 91 \text{ kN} \quad (38)$$

and the limit for elastic displacement as

$$u_{el} = \frac{R_{Rd}}{k_{II}} = \frac{91 \cdot 10^3}{6.3 \cdot 10^6} = 14.4 \text{ mm} \quad (36)$$

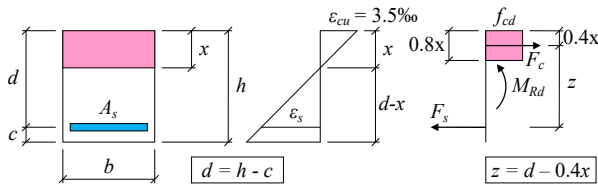

Fig. 7 Wall strip subjected to explosion load

The values presented above are sometimes somewhat rounded off but in the numerical analyses that are presented below the following (exact) values have been used as input parameters:

- Mass: $m = 900 \text{ kg}$
- Stiffness: $k = 6.3 \cdot 10^6 \text{ N/m}$
- Capacity: $R_{Rd} = 91 \text{ kN}$

The (exact) load acting on the SDOF system, see Fig. 1, is determined as

$$F_1 = b \cdot l \cdot P_r^+ = 1.0 \cdot 2.7 \cdot 300 = 810 \text{ kN} \quad (40)$$

$$t_1 = t_{r,\Delta}^+ = 6.4 \text{ ms} \quad (41)$$

giving a total impulse load of

$$I_1 = b \cdot l \cdot i_r^+ = 1.0 \cdot 2.7 \cdot 960 = 2592 \text{ Ns} \quad (42)$$

The time step used in the analysis are $\Delta t = 0.064 \text{ ms}$.

The dynamic response of the model due to this load is shown in Fig. 8, in which the maximum displacement obtained reaches about 48 mm. After that, the mass swings back again

and the system is elastically unloaded. Due to plastic displacement, though, the total displacement never reaches back to zero again. Instead the mass oscillates around an average displacement of about

$$u_{pl} = u_{tot} - u_{el} \approx 48 - 14 = 34 \text{ mm} \quad (43)$$

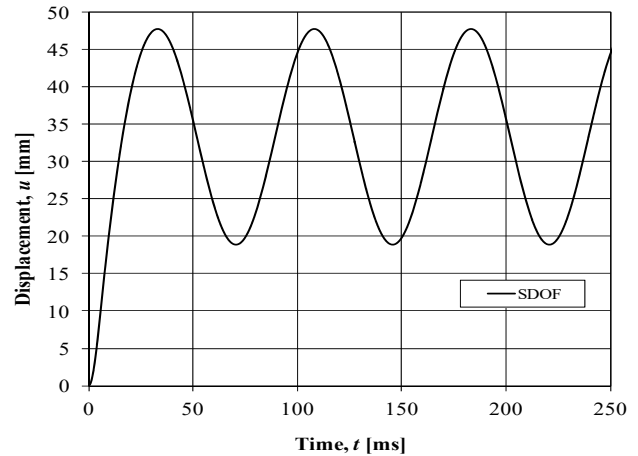

Fig. 8 Displacement-time relation $u(t)$ for studied wall strip

The complementing results from the analysis are shown in Fig. 9 and Fig. 10, where the load-time relation and load-displacement relation, respectively, are shown. In Fig. 9, the load $F(t)$ applied on the system is clear and the internal response $R(t)$ is shown as a comparison. In Fig. 10, the applied force-displacement relation $R(u)$ is clear while the applied load $F(u)$ is shown as a comparison.

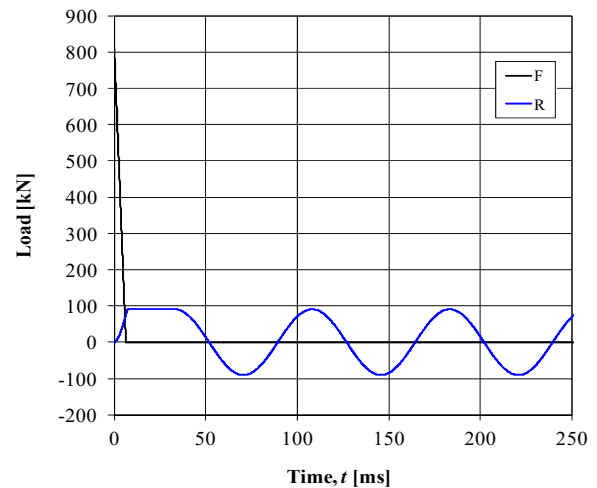

Fig. 9 Load-time relation from numerical analysis of SDOF system

VI. COMPARISON OF RESULTS OF SDOF IMPLEMENTATION IN OPENMODELICA AND EXCEL

In this chapter two SDOF implementations are compared. Sections II, IV, V are explaining the Microsoft Excel implementation and Section III is explaining the OpenModelica implementation of the Case Study presented in

Section V.

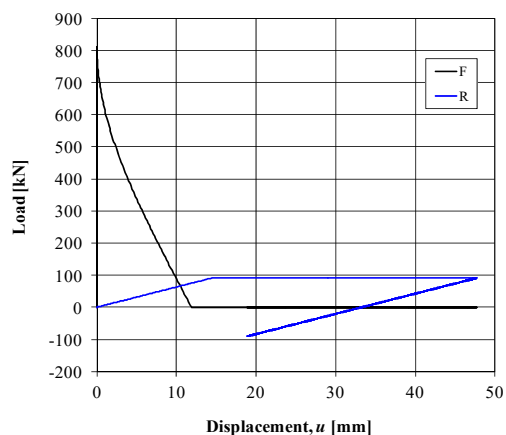

Fig. 10 Load-displacement relation from numerical analysis of SDOF system

The Modelica model parameters are set as shown in Table I. The damping and plastic hardening is set to zero, as well as initial deformation. It is important to notice that the Modelica implementation uses the s_{elas} as input parameter and not the force capacity R_{Rd} . To avoid numerical difference in the solution the complete division between structures force capacity and elastic stiffness should be used as input, see Table I. In the system model the mass of SDOF was set to 900 kg and loadForce time table was set to [0, 0; 0.000064, 810000.0; 0.0064, 0; 1, 0] in [s] and [N].

In Fig. 11, the simulation results of SDOF displacement from both Excel and OpenModelica are shown. The OpenModelica solution traces the Excel solution without any deviation when it comes to rise time, maximum displacement, plastic displacement, elastic amplitude and periodicity of the elastic oscillation. In Appendix – Damping, the influence of damping in the OpenModelica model is briefly shown.

TABLE I
 USED INPUT PARAMETERS FOR SDOF MODELICA MODEL

Name	Value	Unit
D	0	Ns/m
ElasticModule	$6.3 \cdot 10^6$	N/m
$h_{hardeningmodule}$	0	N/m
s_{elas}	$R_{Rd}/k=0.014444$	mm
s_{rel}	0	mm

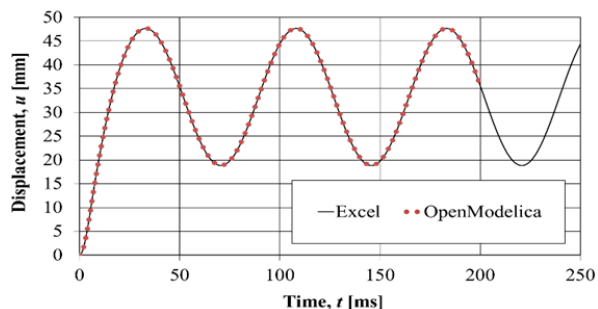

Fig. 11 SDOF displacement as a function of time for Modelica and Excel model

VII. CONCLUSIONS AND DISCUSSIONS

Here it is shown how a concrete structure such as a beam or a wall strip, with various boundary conditions, can be translated into a SDOF model. In addition, how an elastoplastic perfectly plastic model can be used to predict the elastic and plastic displacement of the structure due to an impulse load from an air detonated explosive charge is shown. All MSB references are free to download.

A SDOF model with elastoplastic material behavior was implemented in Excel. In OpenModelica a 1-D elastoplastic translational spring model, which included plastic hardening and damping, was implemented in the Modelica language. The plastic hardening and the damping were set to zero in the case study. The comparison between the two implementations in Excel and OpenModelica of SDOF's time history of the displacement showed perfect agreement. The Excel implementation is an easy to use implementation for a SDOF system. However, if the complexity needs to be increased to become a multi-degree of freedom problem or that the load case is not just force applied input to the system becomes more cumbersome to solve in Excel. However, this is easily extended and modified in Modelica, where one does not have to pre-define how the equations of the systems are used, i.e. one can easily change inputs and what and number of degrees of freedom. In Modelica, it is also easy to include other physical system domains such as air condition, water, and electricity in the same system model. This is to be able to model more of the complete housing or shelter system that needs to manage a reasonable degree of impulsive load.

The Modelica language provides engineers the development environment to design and optimize the complex systems of tomorrow for their intended purpose.

APPENDIX - DAMPING

It is recommended to not include damping in the impulse load simulations of structural response with a SDOF model. This generates conservative results and due to the nature of the applied load the effect of damping is usually small. However, if damping is to be included, it is usually given as a ratio of critical damping. For the SDOF system in (1), the critical damping is calculated by

$$c_{cr} = 2\sqrt{k \cdot m} \quad (44)$$

For the case study described in Section V, the critical damping is $c_{cr} = 150599$ Ns/m. The ratio of critical damping is defined as

$$\zeta = \frac{c}{c_{cr}} \quad (45)$$

Here, the OpenModelica SDOF is simulated with damping ratio $\zeta = 0, 0.01$ and 0.02 , i.e. 0%, 1% and 2% of critical damping, see Fig. 12. This is approximately how many concrete structures have as viscous damping.

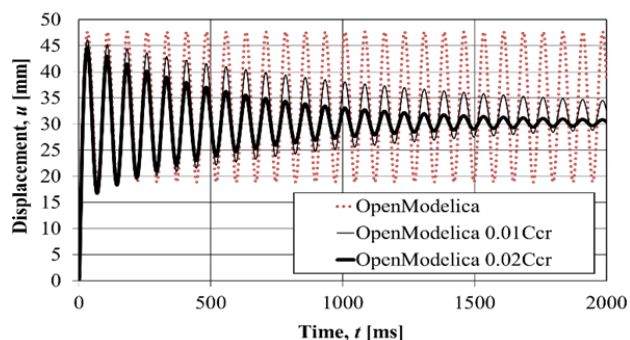

Fig. 12 SDOF displacement in OpenModelica model with different damping ratios

ACKNOWLEDGMENT

The authors acknowledge the support given by MSB and especially Lars Gråbergs. Additionally, members of the West Coast Sweden Shock Wave Group (WCSSWG), and especially Dr. Joosef Leppänen, are highly acknowledged for their input.

REFERENCES

- [1] K-J. Bathe, Finite Element Procedures, Prentice-Hall, Englewood Cliffs, New Jersey, USA, 1996.
- [2] J. M. Biggs, Introduction to Structural Dynamics, McGraw-Hill, New-York, USA, 1964.
- [3] Eurocode 2: Design of Concrete Structures – Part 1-1: General rules and rules for buildings, European Committee for Standardization, Brussels, Belgium, 2004.
- [4] ConWep – Collection of conventional weapons effects calculations based on TM 5-855-1, Fundamentals of Protective Design for Conventional Weapons, U.S. Army Engineer Waterways Experiment Station, Vicksburg, USA, 1992.
- [5] Structures to Resist the Effects of Accidental Explosions. UFC 3-340-02, Department of Defense, USA, 2008.
- [6] J. Ekström, Blast and Impact Loaded Concrete Structures. Engineering, Chalmers University of Technology, PhD Thesis, Göteborg, Sweden, 2017.
- [7] M. Johansson, Structural Behaviour in Concrete Frame Corners of Civil Defence Shelters: Non-linear Finite Element Analyses and Experiments, Department of Concrete Structures, Chalmers University of Technology, PhD Thesis, Publication 00:2, Göteborg, Sweden, 2000.
- [8] J. Johansson, Central differensmetod (Central difference method. In Swedish.), Swedish Civil Contingencies Agency, B03-102, 2012-10-15, Karlstad, Sweden, 2012.
- [9] J. Johansson, Luftstötövåg (Air shockwave. In Swedish.), Swedish Civil Contingencies Agency. Publ.no. MSB448, Karlstad, Sweden, 2012.
- [10] J. Johansson and L. Laine, Bebyggelsens motståndsför-måga mot extrem dynamisk belastning, Del 1: Last av luftstötövåg (The resistance of housing settlement subjected to extreme dynamic loading. Part 1: Load of shock wave in air. In Swedish.), Swedish Civil Contingencies Agency, Publ. no. MSB449, Karlstad, Sweden, 2012.
- [11] J. Johansson and L. Laine, Bebyggelsens motståndsför-måga mot extrem dynamisk belastning, Del 2: Explosion i gatukorsning (The resistance of housing settlement subjected to extreme dynamic loading. Part 2: Explosion at an urban intersection. In Swedish.), Swedish Civil Contingencies Agency, Publ. no. MSB450, Karlstad, Sweden, 2012.
- [12] J. Johansson and L. Laine, Bebyggelsens motståndsför-måga mot extrem dynamisk belastning, Del 3: Kapacitet hos byggnader (The resistance of housing settlement subjected to extreme dynamic loading. Part 3: Building capacity. In Swedish.), Swedish Civil Contingencies Agency, Publ. no. MSB142, Karlstad, Sweden, 2012.
- [13] L. Laine, Markstötövåg (Ground shock wave. In Swedish.), Swedish Civil Contingencies Agency, Publ.no. MSB344, Karlstad, 2012.
- [14] J. Leppänen, Concrete Structures Subjected to Fragment Impacts – Dynamic Behaviour and Material Modelling, Department of Concrete Structures, Chalmers University of Technology, PhD Thesis, Publication

04:4, Göteborg, Sweden, 2004.

- [15] J. Leppänen, Splitterverkan (Splinter effects, In Swedish.), Swedish Civil Contingencies Agency, Publ.nr MSB345, Karlstad, Sweden, 2012.
- [16] U. Nyström, Modelling of Concrete Structures Subjected to Blast and Fragment Loading. Division of Structural Engineering, Chalmers University of Technology, PhD Thesis, no. 3486, Göteborg, Sweden, 2013.
- [17] J. Johansson, Strukturrespons vid impulsbelastning (Structural response at impulse loading. In Swedish.), Swedish Civil Contingencies Agency, B03-101, 2014-04-16, Karlstad, Sweden, 2014.
- [18] Modelica - A Unified Object-Oriented Language for Systems Modeling, Modelica Association, language specification and relevant documents can be freely downloaded at <https://www.modelica.org>, 2019.
- [19] OpenModelica, an open-source Modelica-based modeling and simulation environment intended for industrial and academic usage, Open Source Modelica Consortium, can be freely downloaded at <https://www.openmodelica.org>, 2019.
- [20] A. Öshcner, Elasto-Plasticity of Frame Structure Elements Modeling and Simulation of Rods and Beams, Springer Verlag, p588, DOI 10.1007/978-3-662-44225-8, 2014.
- [21] L. Petzold, A Description of DASSL: A Differential/Algebraic System Solver, SAND82-8637, Applied Mathematics Division, Sandia National Laboratories, Livermore, CA, USA, 1982.
- [22] Swedish Civil Contingencies Agency (MSB) documents can be freely downloaded at <https://www.msb.se/skyddsrum>, 2019.