

The Design of Broadband 8x2 Phased Array 5G Antenna MIMO 28 GHz for Base Station

Muhammad Saiful Fadhil Reyhan, Yusnita Rahayu, Fadhel Muhammadsyah

Abstract—This paper proposed a design of 16 elements, 8x2 linear fed patch antenna array with 16 ports, for 28 GHz, mm-wave band 5G for base station. The phased array covers along the azimuth plane to provide the coverage to the users in omnidirectional. The proposed antenna is designed RT Duroid 5880 substrate with the overall size of 85x35.6x0.787 mm³. The array is operating from 27.43 GHz to 28.34 GHz with a 910 MHz impedance bandwidth. The gain of the array is 18.3 dB, while the suppression of the side lobes is -1.0 dB. The main lobe direction of the array is 15 deg. The array shows a high array gain throughout the impedance bandwidth with overall of VSWR is below 1.12. The design will be proposed in single element and 16 elements antenna.

Keywords—5G antenna, 28 GHz, MIMO, omnidirectional, phased array, base station, broadband.

I. INTRODUCTION

THE last ten years have seen a massive growth in the number of connected wireless devices. Billions of devices are connected and controlled by wireless networks. The device needs a high throughput to support applications such as voice, data, movies, and games. Thus, demands for wireless throughput and the number of wireless devices will always increase [1]. Multiple-input multiple-output (MIMO) has been used in 4G long term evolution (LTE) as one of technologies likely to be adopted in 5G to increase data peak rate for low signal-to-noise ratio [6]. The large number of MIMO can be explored for a massive number of critical capabilities including: higher antenna gain; higher spatial multiplexing gain; and better efficiency [3].

In the past decade, planar antennas have attracted interest for millimeter-wave phased arrays because of their features of broadband antenna, ease of fabrication, and high-efficiency. Several types of planar antennas have been developed for phased array systems [7]. Phased arrays can cover their radiation patterns as well and cancel out the information in unwanted directions [2]. There is an enormous expanse in the millimeter wave spectrum, more specifically 28 GHz and beyond that is largely overlooked until now. On October 22nd 2015, FCC proposed new rules for wireless broadband frequencies of 28 GHz, 37 GHz, 39 GHz and 64 - 71 GHz bands [4]-[6]. The purpose of this paper is to design an array antenna for base station with frequency of 28 GHz. In this paper, a new design of 8x2 elements with 16 ports fed patch

M. Saiful Fadhil Reyhan, Yusnita Rahayu as the senior lecturer, and Fadhel Muhammadsyah are with the Electrical Engineering Department, University of Riau, Pekanbaru, Indonesia (e-mail: muhammad.saifulfadhilreyhan@student.unri.ac.id, yusnita.rahayu@lecturer.unri.ac.id, fadhel.muhammadsyah@student.unri.ac.id).

antenna has been used to form phased array to obtain an omnidirectional on azimuth plane radiation. Each element contains an element feeding until whole element.

II. SINGLE ELEMENT ANTENNA CONFIGURATION

A. Design of the Element Sub-Array

The proposed 5G antenna is designed using RT Duroid 5880 substrate with thickness of 0.787 mm, dielectric constant of 2.2 and loss tangent of 0.0009. The dimension of single component is illustrated on Figs. 1 (a) and 1(b). The simulated reflection coefficient (S11) of the single element is described in Fig. 2. It confirms that the proposed antenna below -10 dB S11 operating at 28 GHz. More than 0.91 GHz of impedance bandwidth (27.43 GHz to 28.34 GHz) of bandwidth is obtained.

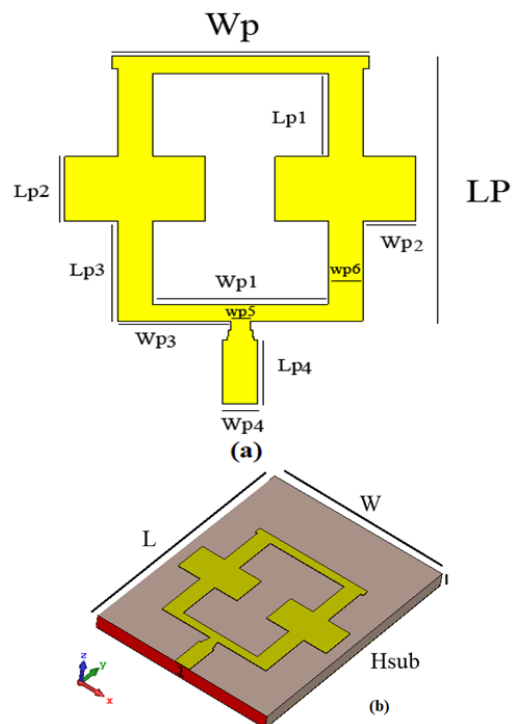

Fig. 1 Dimension of single element (a) Patch (b) sub array antenna

B. Simulated Results and Discussion of the Element Sub-Array

These results show that the array has an impedance bandwidth of 9100 MHz from 27.43 GHz to 28.34 GHz. The optimized parameters for the proposed antenna are shown in Table I. As far as the frequency dependency of the array

radiation pattern concerned, it has a stable array gain throughout the 910 MHz bandwidth as shown in Fig. 3.

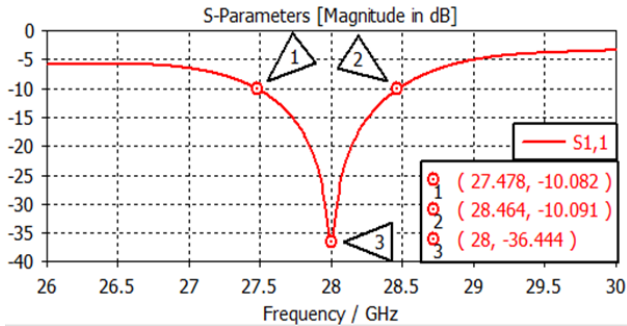

Fig. 2 Return loss of single element antenna

TABLE I
 FINAL DIMENSIONS OF THE ANTENNA PARAMETERS

Parameter	Value (mm)
Wsub	10.7
Lsub	Wp1
Hsub	4.7
Wp	Lp3
Lp	10.2
Wp1	4.7
Lp1	2.63
Wp2	1.4
Lp2	2.04
Wp3	2.97
Lp3	3.12
Wp4	0.954
Lp4	2.02
Wp5	0.54
Wp6	0.93

The proposed antenna, the 3D antenna radiation patterns at 28 GHz, is illustrated in Fig. 3 (a). As shown, the antenna has a good radiation performance with directional pattern 7.45 dB realized gain at frequencies operation. In addition, Fig. 3(b) shows the simulated current distribution for the antenna at 28 GHz, most of the current flows are concentrated around the single element antenna. The voltage standing ratio shown in Fig. 4 is about 1.0306, almost closer to the ideal value of voltage standing wave ratio.

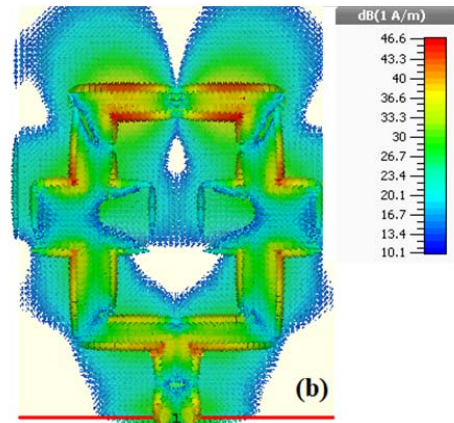
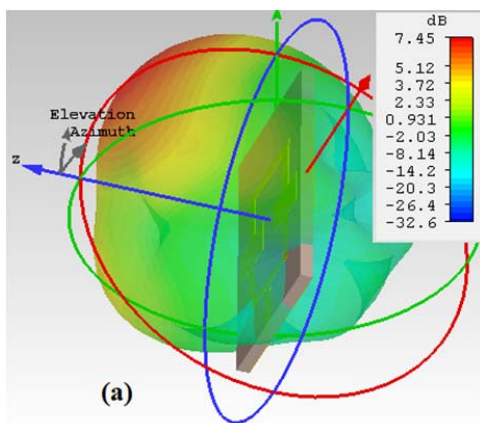

Fig. 3 Simulated (a) radiation pattern characteristics of the antenna at 38 GHz and (b) current distribution

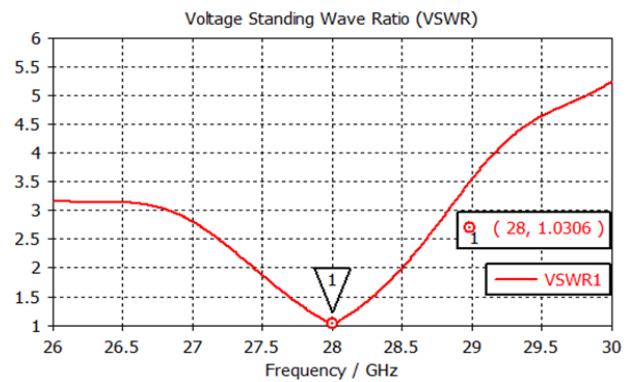

Fig. 4 Voltage standing wave ratio of single element antenna

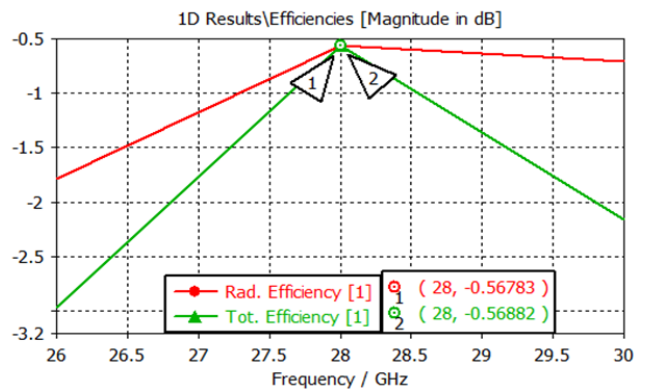

Fig. 5 Radiation and total efficiency of single antenna

The radiation efficiency and total efficiency simulated results is described in Fig. 5. The antenna has good efficiency function, at the frequency range from 38 GHz, the antenna has more than -0.567 dB and -0.568 dB value of radiation efficiency and total efficiency, respectively.

III. DESIGN OF 8X2 PHASED ARRAY ANTENNA

We have arranged single element antenna to form an 8x2 patch array as shown in Fig. 6. This arrangement is advantageous for omnidirectional radiation pattern, each port can separately excited using waveguide port.

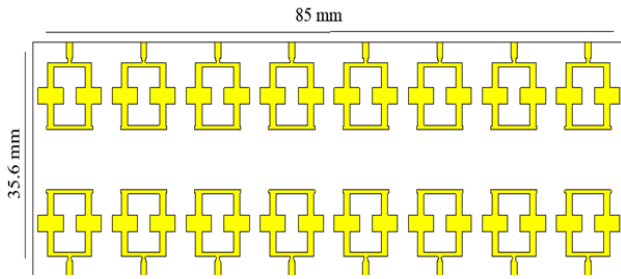

Fig. 6 Dimension of 8x2 linear array antenna

A. Simulated Results and Discussion of the 8x2 Linear Array Antenna

We have simulated the 8x2 array. As shown in Fig. 7, the isolations between the consecutive ports, S11, S21, S31 etc., are well below -20 dB which show a lesser mutual coupling between them. The array gain is 18.3 dB which is good gain for mobile station, while the sidelobe level is -1.1 dB as shown in Figs. 8 (a), and (b) shows the azimuth plane radiation patterns, respectively.

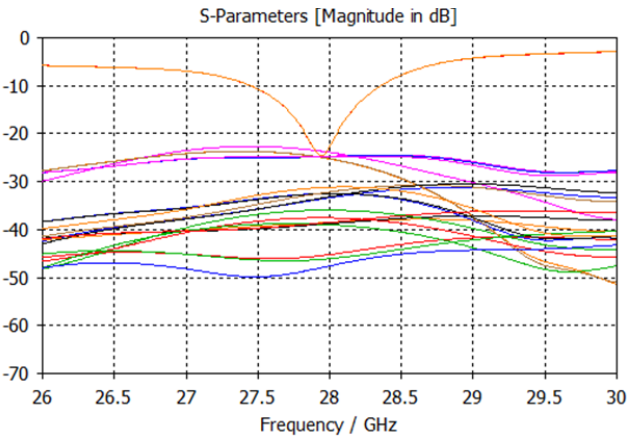

Fig. 7 Port isolations S11, S21, S31, etc.

The radiation efficiency and total efficiency simulated results are described in Fig. 9. The antenna has good efficiency function, at the frequency range from 28 GHz, the antenna has more than -0.359 dB and -0.746 dB value of radiation efficiency and total efficiency, respectively. It has the greater radiation efficiency than single element, but the lower at total efficiency.

The Voltage Standing Wave Ratio (VSWR) has a great matched impedance about 1.115 shown on Fig. 10, it almost approached the ideal VSWR.

IV. CONCLUSION

The new design of 8x2 phased array design for 28 GHz has been proposed. The array has a bandwidth of 910 MHz, with a 18.3 dB gain and an acceptable sidelobe level of -1.0 dB with main lobe direction is 15 deg. The VSWR is below 1.12, it exhibits a good standing wave behaviour while achieving the matching at the last element through the feeding sub array, to effectively radiate the maximum power arriving at the last element. As far as the frequency dependency of the array is

concerned, within the operational bandwidth, it has a stable array gain.

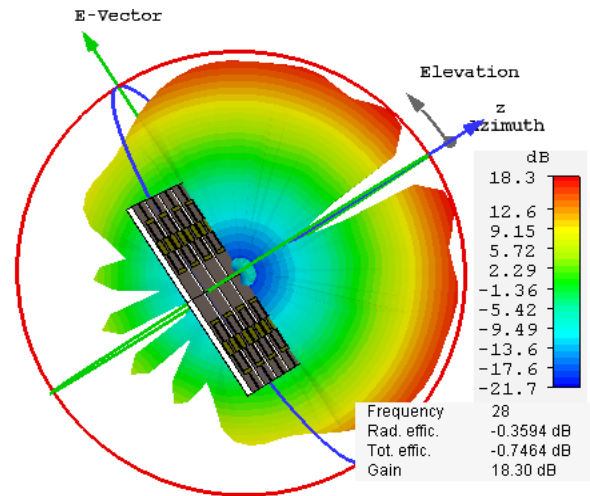

Fig. 8 (a) 3D Array gain with end-fire on azimuth plane

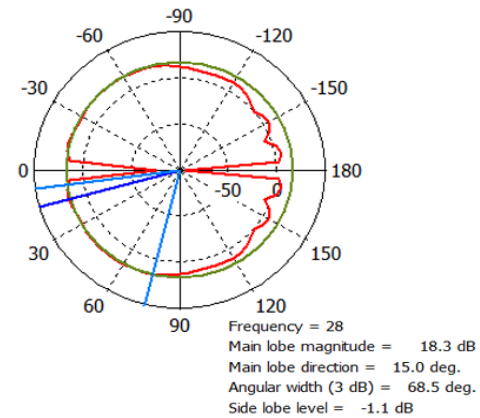

Fig. 8 (b) Array gain polar radiation on azimuth plane

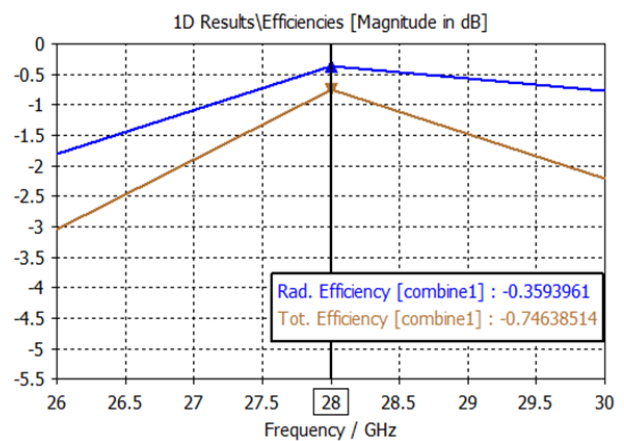

Fig. 9 Radiation and Total Efficiency of Array Antenna

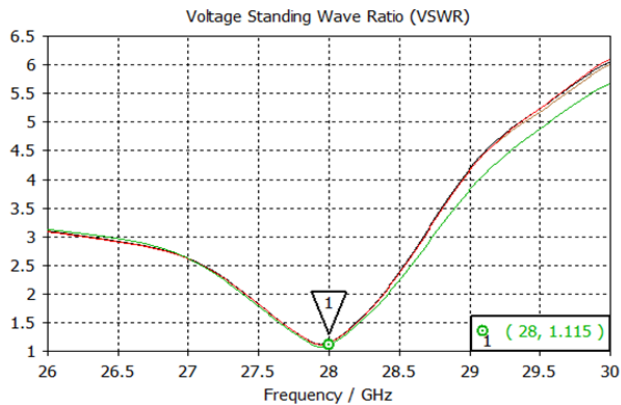

Fig. 10 Voltage Standing Wave Ratio array 8x2 antenna

REFERENCES

- [1] M. M Mamdouh, Ali, A. R Sebak "Design of Compact Millimeter Wave Massive MIMO Dual- band (28/38 GHz) Antenna Array for Future 5G Communication Systems," *IEEE International Symposium on Antenna Technology and Applied Electromagnetics (ANTEM)*, Montreal, 2016.
- [2] A. K. Pandey, "Design of a Compact High Power Phased Array for 5G FD MIMO System at 29 GHz". *Proceeding of The Asia -Pasific Microwave Conference*, 2016.
- [3] A. Sayeed, J. Brad, "Beamspace MIMO Channel Modeling and Measurement: Methodology and Result at 28 GHz," New York: Springer-Verlag, 2016.
- [4] M. E. Shorbagy, R. M Shubair, M. I. AlHajri, and N. K. Mallat, "On Design of Milimetre-Wave Antennas for 5G," *IEEE Mediteranian Microwave Symposium (MMS)*, Abu Dhabi, 2016.
- [5] D. Psychoudakis, H. Zhou, B. Biglarbegian, T. Henige, and F. Aryanfar., "Mobile Station Radio Frequency Unit for 5G Communications at 28 GHz," *IEEE International Microwave Symposium (IMS)*, San Francisco, CA. 2016.
- [6] J. Lota, S. Sun, T. S. Rappaport, and A. Demosthenous, "5G Uniform Linear Arrays with Beamforming and Spatial Multiplexing at 28, 37, 64, and 71 GHz for Outdoor Urban Communication: A Two-Level Approach," *IEEE Transactions on vehicular technology*, Vol. 66, No. 11, pp. 9972-9985, 2017.
- [7] S. X. Ta, H. Choo, and I. Park, "Broadband Printed-Dipole Antenna and Its Arrays for 5G Applications," *IEEE Antennas and Wireless Propagation Letters*, Vol. 16, pp. 2183-2186, 2017.