

Calibrations and Effect of Different Operating Conditions on the Performance of a Fluid Power Control System with Servo Solenoid Valve

Tahany W. Sadak, Fouly, A. Anwer, M. Rizk

Open Science Index, Mechanical and Mechatronics Engineering Vol:12, No:9, 2018 publications.waset.org/10009559.pdf

Abstract—The current investigation presents a study on the hydraulic performance of an electro-hydraulic servo solenoid valve controlled linear piston used in hydraulic systems. Advanced methods have been used to measure and record laboratory experiments, to ensure accurate analysis and evaluation. Experiments have been conducted under different values of temperature (28, 40 and 50 °C), supply pressure (10, 20, 30, 40 and 50 bar), system stiffness (32 N/mm), and load (0.0 & 5560 N). It is concluded that increasing temperature of hydraulic oil increases the quantity of flow rate, so it achieves an increase of the quantity of flow by 5.75 % up to 48.8 % depending on operating conditions. The values of pressure decay at low temperature are less than the values at high temperature. The frequency increases with the increase of the temperature. When we connect the springs to the system, it decreases system frequency. These results are very useful in the process of packing and manufacturing of fluid products, where the properties are not affected by 50 °C, so energy and time are saved.

Keywords—Electro Hydraulic Servo Valve, fluid power control system, system stiffness, static and dynamic performance.

I. INTRODUCTION

FLUID power system must provide optimum accuracy, system stability, and minimum energy consumption. These could be accomplished by controlling fluid pressure, direction of flow and flow rate using different types of control valves. The greatest advantage of that is its versatility to be controlled by a feather touch and drive a large power and its precision in its application when used in repeated loading with close tolerance, [1]. In the fast-growing computer/electronics world, it is still advantageous and easy to control this power muscle remotely, smoothly, efficiently, safely and precisely.

Hydraulic systems are complex and pose nonlinearities, which make the modeling and design of feedback controller challenging. The nonlinearities are mainly due to servo-valve flow - pressure characteristics, orifice area openings, feedback and flow force effects [2], [3], variation of fluid volume under compression, in addition to cavitation and seal friction. Aside from the nonlinearities, hydraulic systems contain large extent of model uncertainties [4].

Tahany W. Sadak (Assistant Professor) is with the Department of Production Engineering and Design Faculty of Engineering, Beni-Suef University Beni-Suef, Egypt (corresponding author, phone: 02-01222675569; e-mail: tahanywilliam@gmail.com).

Fouly (Assistant Professor) and A. Anwer (Professor) are with the Department of Production Engineering and Design Faculty of Engineering, El-Minia University El-Minia, Egypt (e-mail: Ahmed.fouly@mu.edu.eg, mahassenri@yahoo.com).

Many investigations have been done studying the performance of hydraulic control systems. Federlein [5], [6] studied the flow-pressure relationship, load, supply pressure, advantages of closed loop systems.

TABLE I
 NOMENCLATURE

Symbol	Quantity	Units to SI
A	cylinder flow area, throttle valve flow-area	mm ²
D	inner diameter of hydraulic cylinder.	mm
d	diameter of piston rod of the hydraulic cylinder	mm
f	frequency	Hz
f _{b,w}	Frequency at -3 db	Hz
K	system stiffness	N/mm
p _c	control pressure in spool valve; (ps-p1)	bar
p _s	supply pressure	bar
p _{sa}	actual value of supply pressure.	bar
p ₁ , p ₂	cylinder inlet and return pressures	bar
Q	system flow rate	l/min
t	time	s
v	piston speed.	mm/s
W	load of the system	N
x	piston displacement	mm
Φ	opening of electro hydraulic servo solenoid valve	%
Abbreviations		
A, B	Working lines	
EHSSV	Electro Hydraulic Servo Solenoid Valve	
p	Supply pressure line	
T	Return (Tank) line	

II. EXPERIMENTAL WORK

The present experimental investigation studies the performance of (using a low friction, double acting) hydraulic cylinder. This cylinder is shown schematically in Fig. 1; a hydraulic control system using an Electro Hydraulic Servo Solenoid Valve (EHSSV; Catalogue, Bosch Rexroth) [7]. The displacement and speed of the piston of the hydraulic cylinder accordingly the flow rate has been experimented under different values of temperature (28 up to 50 °C), supply pressure (50 bar), system stiffness (32 N/mm), and load (0.0 up to 5560 N).

Pressure drop during piston displacement is conducted. A 3-dimensional drawing for the control system and the hydraulic power supply unit is shown in Fig. 2. Fig. 3 shows schematic of the designed experimented system.

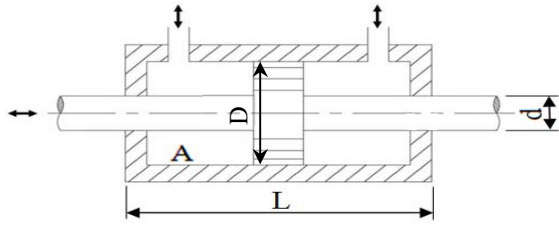

Fig. 1 Schematic drawing of double acting, double rod hydraulic cylinder. ID = 80 mm, d = 45 mm, L = 190 mm, $p_{max.} = 210$ bar, $A = 3436.116965$ mm²

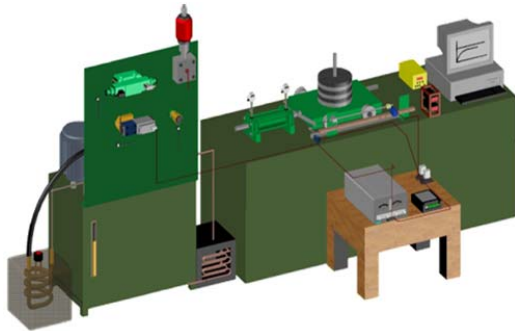

Fig. 2 Investigate fluid power control system in 3-D drawing

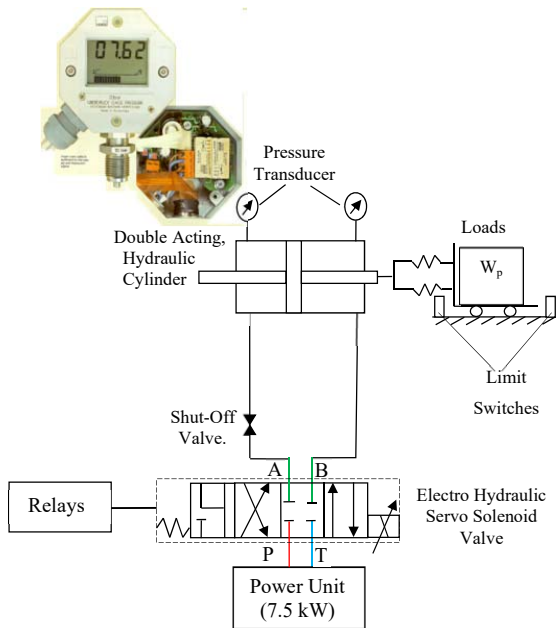

Fig. 3 Hydraulic circuit of fluid power control system (7.5 kW)

The initial and final values (at the beginning and end of piston stroke) of system pressure supply (p_s), the inlet pressure to the hydraulic cylinder (p_1) and the outlet pressure of the hydraulic cylinder (p_2) have been registered, while the values during piston movement have been traced simultaneously using the Digibar transducers (HBM Electrical Measurement of Mechanical Quantities, Digibar pressure transducers) [8] and recorded. Piston displacement ($L = 190$ mm) has been traced also using the inductive displacement transducer (HBM Electrical Measurement of Mechanical Quantities, Inductive displacement transducers W10...W200) [9] and Amplifier with

Digital Indicator [10].

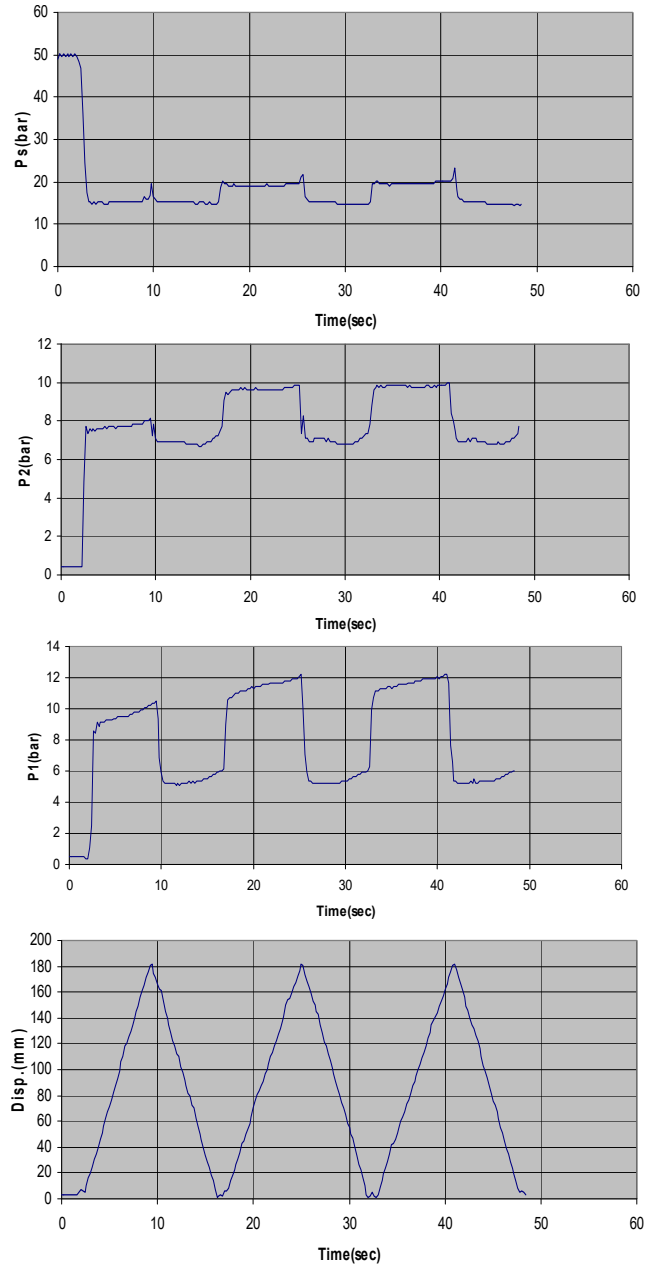

Fig. 4 Example for experimental time charts of system performance under load; $w = 5560$ N for $p_s = 50$ bar, without springs at $t = 50$ °C, in case of full stroke

All traced variables are recorded versus time using the 4-channel USB recorder/logger device [11]. Example for the recorded chart is shown in Fig. 4.

TABLE II
 DYNAMIC VISCOSITY OF OIL AT DIFFERENT TEMPERATURES

Oil Temperature; T [°C]	28	40	50
Dynamic viscosity; μ [Ns/m ²]	36	21	13

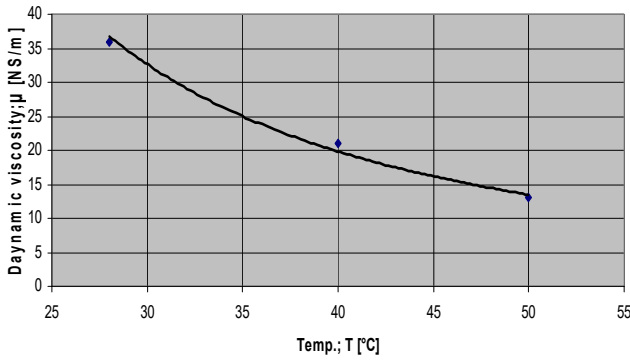

Fig. 5 Effect of temperature on the dynamic viscosity of the oil

Calibrating the frequency inverter and hydraulic pump at different oil temperature indicates that higher frequency value is needed to achieve the same supply pressure at 28 °C. Comparison between calibration curves at 28, 40, and 50 °C had been plotted in Fig. 6. This observation could be donated to the fact that increasing the temperature decreases the viscosity of the hydraulic oil, accordingly it requires more energy, i.e., higher frequency in order to get the same supply pressure at low temperature.

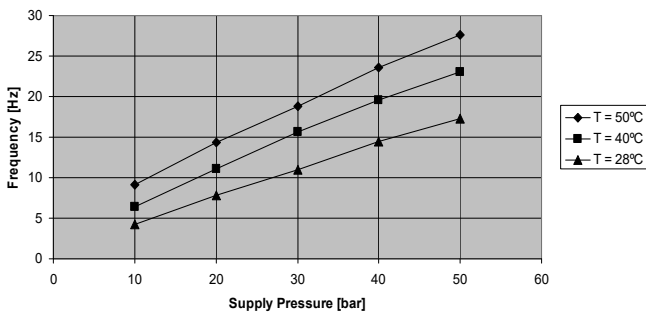

Fig. 6 System supply pressure at different temperatures

TABLE III
 ACTUAL SUPPLY PRESSURE UNDER LOAD; W = 5560 N AND K = 32 N/MM

p_s [bar]	10	20	30	40	50
T [°C]	p_{sa} [bar]				
28	6.28	10.55	14.49	17.29	20.56
40	4.57	7.87	10.55	13.20	16.32
50	4.13	6.80	9.62	12.58	15.68

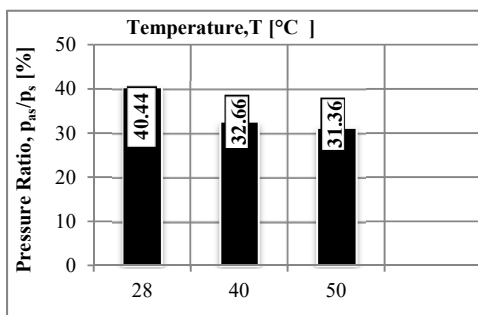

Fig. 7 Percentage of decrease of actual supply pressure due to increasing temperature

III. CALIBRATIONS

A. Effect of Temperature on Fluid

The oil used in the system of the present investigation is of type CO-OP Hydraulic 4 ISO VG 68. The viscosity of the oil is measured at room temperature using a portable viscometer the oil temperature was 28 °C, then the oil is heated to 40 and 50 °C. The measured values are registered in Table I and a calibration curve between the temperature and dynamic viscosity has been drawn in Fig. 5 illustrating this relationship. As the temperature of the fluid increases, its viscosity decreases.

IV. RESULTS AND EVALUATION

A. Evaluation of System Supply Pressure

In this investigation, the effect of temperature is studied, and due to that effect of temperature on the actual supply pressure it must be registered to know its effect on the performance of system.

The values of actual supply pressure are presented for the first case under free-load and without springs, the second case under free-load and with springs 32 N/mm, the third and fourth cases under full-load, without and with springs at 28, 40 and 50 °C. These values are presented in Table III, only the maximum pressure is plotted as percentage in Fig. 7.

The value of the flow rate; Q for each condition of temperature values; T = 28, 40 and 50 °C and under different values of supply pressure; p_s equals 10, 20, 30, 40 and 50 bar without/with connecting springs has been determined from the experimental traced records. All records are under free-load and load; W = 5560 N.

B. Loading Effect

Variation of the load in system affects its performance. The results are registered in Table IV and plotted in Fig. 8.

TABLE IV
 VARIATION OF SYSTEM FLOW RATE; Q WITH DIFFERENT VALUES OF SUPPLY PRESSURE; p_s FOR LOAD; W = 0.0 & 5560 N

p_s [bar]	10	20	30	40	50
W [N]	Q [ml/s]				
0.0	12.13	24.73	35.87	51.81	61.59
5560	11.45	2313	34.36	45.98	51.00

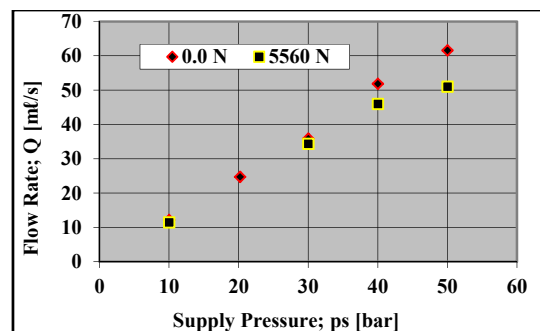

Fig. 8 Variation of system flow rate; Q versus supply pressure at free-load and load, W = 5560 N

According to Fig. 8, it could be concluded that the flow rate decreases by increasing the load. This could be explained as increasing the load increases the back pressure; p_1 , therefore the control pressure; p_c decreases. Hence, the flow rate; Q decreases.

C. Temperature and Stiffness Effect

The value of the flow rate; Q for variation conditions of temperatures, load and supply pressure without/with connecting springs has been determined from the experimental traced records. The speed of the piston of the hydraulic cylinder is calculated from the experiment.

The flow rate output from the servo solenoid valve at full opening; Φ and load, $W = 0.0$ N with springs; $k=32$ N/mm. at temperature 28°C is 57.26 ml/s, while at 40°C is 60.45 ml/s and at 50°C equal 74.18 ml/s. These values are presented in Table V. So, the increasing of temperature achieves an increase in the flow rate value at 40°C by 5.75% more than at 28°C , while the increase at 50°C is 29.55% more than that at 28°C . Results are interpreted versus supply pressure; p_s in Fig. 9.

TABLE V

ARIATION OF SYSTEM FLOW RATE; Q WITH DIFFERENT VALUES OF SUPPLY PRESSURE; p_s FOR TEMPERATURE; $T = 28, 40$ AND 50°C , LOAD; $W = 0.0$ N WITH SPRINGS; $K=32\text{N/MM}$

p_s [bar]	10	20	30	40	50
$T [^\circ\text{C}]$	Q [ml/s]				
28	11.1	22.51	33.31	44.1	51
40	13.95	27.9	39.1	50.2	57.76
50	19.09	35.48	49.45	65.3	75.9

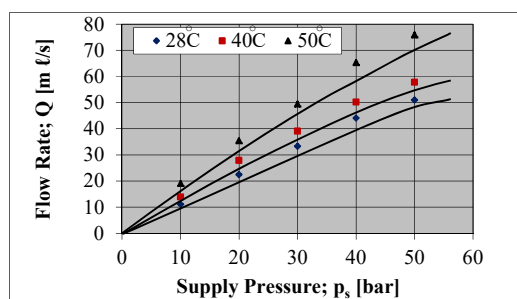

Fig. 9 Variation of system flow rate; Q versus supply pressure; p_s at $W = 5560$ N for $t = 28, 40,$ and 50°C , with $k = 32$ N/mm.

In the same conditions under load, the increasing of temperature achieves an increase in the flow rate value at 40°C by 13.25% more than at 28°C , while the increase at 50°C is 48.8% more than that at 28°C under load, $W = 5560$ N. Results are recorded in Table VI and interpreted in Fig. 10.

TABLE VI

ARIATION OF SYSTEM FLOW RATE; Q WITH DIFFERENT VALUES OF SUPPLY PRESSURE; p_s FOR TEMPERATURE; $T = 28, 40$ AND 50°C , LOAD, $W = 5560$ N WITH SPRINGS; $K=32\text{N/MM}$

p_s [bar]	10	20	30	40	50
$T [^\circ\text{C}]$	Q [ml/s]				
28	11.14	23.65	30.79	47.3	57.26
40	14.44	26.75	39.33	51.82	60.45
50	17.93	36.62	49.46	60.45	74.18

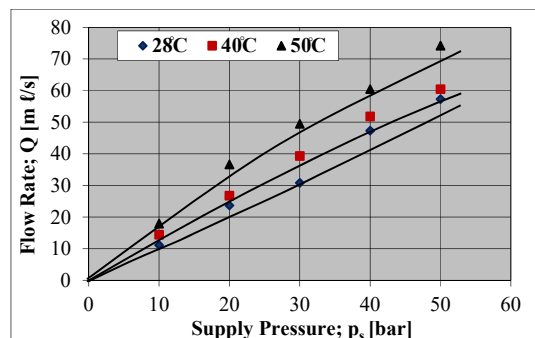

Fig. 10 Variation of system flow rate; Q versus supply pressure; p_s at free-load for $t = 28, 40$ and 50°C , with $k=32\text{N/mm}$

The comparison in case of free-load and under load revealed that connecting springs with stiffness 32 N/mm to the system achieves higher flow rate at high temperature.

TABLE VII

ARIATION OF SYSTEM FREQUENCY, AT $T=28, 40$ AND 50°C FOR DIFFERENT SUPPLY PRESSURE VALUES.

p_s [bar]	f [Hz], $l=190$ [mm]					
	$k=0.0\text{N/mm}$		$k=32$ N/mm.		$k=32$ N/mm,	
$T [^\circ\text{C}]$	Load; $W = 0.0$ N	Load; $W = 0.0$ N	Load; $W = 5560$ N	Load; $W = 5560$ N	Load; $W = 5560$ N	Load; $W = 5560$ N
	10	50	10	50	10	50
$T=28$	0.0185	0.0936	0.0175	0.0877	0.0170	0.078
$T=40$	0.0237	0.1020	0.022	0.0925	0.0214	0.0877
$T=50$	0.0282	0.119	0.0275	0.1136	0.029	0.1163

TABLE VIII

SYSTEM BANDWIDTH FREQUENCIES; $F_{b,w}$ FOR DIFFERENT OPERATING CONDITIONS

Operating Condition	p_s [bar]				
	10	20	30	40	50
$W = 0.0$ & $T = 28$	0.032	0.054	0.09	0.13	0.15
$W = 0.0$ & $T = 40$	0.039	0.068	0.092	0.13	0.16
$W = 0.0$ & $T = 50$	0.042	0.074	0.11	0.13	0.17
$W = 0.0, K = 32$ & $T = 28$	0.027	0.055	0.08	0.1	0.12
$W = 0.0, K = 32$ & $T = 40$	0.033	0.063	0.091	0.11	0.14
$W = 0.0, K = 32$ & $T = 50$	0.042	0.078	0.11	0.13	0.15
$W = 5560, K = 32$ & $T = 28$	0.024	0.051	0.075	0.1	0.12
$W = 5560, K = 32$ & $T = 40$	0.031	0.065	0.088	0.11	0.14
$W = 5560, K = 32$ & $T = 50$	0.041	0.077	0.098	0.12	0.16

Comparing the results in Tables VII and VIII shows that with increasing of load, the value of bandwidth frequency and the frequency of piston displacement decreases.

Comparing the results, it could be observed that connecting springs to the system of the bandwidth frequency and the frequency of piston displacement decreases.

Comparing the results shows that with increasing of temperature the values of bandwidth frequency and the frequency of piston displacement also increases.

Finally, it could be observed that, with increase of supply pressure, the values of bandwidth frequency and the frequency of piston displacement increase.

From the above tables, it is concluded that in all cases and conditions with increase of temperature, the stroke time decreases. Accordingly, with this higher power the piston of

the hydraulic cylinder moves faster than that at low temperature.

V. CONCLUSIONS

- Increasing the temperature of hydraulic oil requires higher power in order to achieve the same supply pressure of the system, which increases the flow rate consequently.
- Increasing of temperature increases the quantity of flow, so it achieves a changing of the quantity of flow by 5.75 % up to 48.8 % Depending on operating conditions.
- The dynamic performance of the system is affected by changing of operating conditions. Increasing the temperature and the supply pressure of the system increases the bandwidth frequency but increasing of load decreases the bandwidth frequency values especially at high values of supply pressure, while, connecting springs decreases the band width frequency.
- Saving time and energy.

REFERENCES

- [1] Sundaram, Shanmuga K., Hydraulic and Pneumatic Controls, S. Chand & Company Ltd, India (2006).
- [2] Arafa, H. A. and Rizk, M., Identification and Modeling of Some Electrohydraulic Servo-Valve Nonlinearities, Proc. Instn Mech. Engrs, Part C (1987), 201 (C2), pp. 137 - 144.
- [3] Arafa, H. A. and Rizk, M., Spool Hydraulic Stiffness and Flow Force Effects in Electrohydraulic Servo-Valves, Proc. Instn Mech. Engrs, Part C (1987), 201 (C3), pp. 193 - 199.
- [4] Sadak, T. W., Rizk, M. and Marzouk, W. W., Effect of Fluid Power Control System Designs on Static and Dynamic Performance of Hydraulic Cylinders, Minia University Press, July (2007), Vol. 26, No. 2. pp. 120 - 130.
- [5] Federlein, H. G., How to Analyze Steady-State Flow in a Hydraulic System, Hydraulics & Pneumatics, June (1976), pp. 61 - 62.
- [6] Federlein, H. G., How to Analyze Steady-State Pressure in a Hydraulic System, Hydraulics & Pneumatics, June (1976), pp. 70 - 72.
- [7] Servo Solenoid Valves Catalogue, Bosch Rexroth AG, Industrial Hydraulics, Zum Eisengießer 1, D - 97816 Lohr am Main, Germany.
- [8] Digibar Pressure Transducers, HBM, Hottinger Baldwin Messtechnik, GmbH, Postfach 4235, Im Tiefen See 45, D - 6100 Darmstadt 1, Germany.
- [9] Inductive Displacement Transducers, HBM, Hottinger Baldwin Messtechnik, GmbH, Postfach 4235, Im Tiefen See 45, D - 6100 Darmstadt 1, Germany.
- [10] Amplifier With Digital Indicator, HBM, Hottinger Baldwin Messtechnik GmbH, Postfach 4235, Im Tiefen See 45, D - 6100 Darmstadt 1, Germany.
- [11] Channel USB Recorder / Logger Catalogue, Velleman Instruments (2003), Legen Heirweg 33, 9890 Gavere, Belgium.