

Gas Sweetening Process Simulation: Investigation on Recovering Waste Hydraulic Energy

Meisam Moghadasi, Hassan Ali Ozgoli, Foad Farhani

II. PROCESS DESCRIPTION

Abstract—In this research, firstly, a commercial gas sweetening unit with methyl-di-ethanol-amine (MDEA) solution is simulated and comprised in an integrated model in accordance with Aspen HYSYS software. For evaluation purposes, in the second step, the results of the simulation are compared with operating data gathered from South Pars Gas Complex (SPGC). According to the simulation results, the considerable energy potential contributed to the pressure difference between absorber and regenerator columns causes this energy driving force to be applied in power recovery turbine (PRT). In the last step, the amount of waste hydraulic energy is calculated, and its recovery methods are investigated.

Keywords—Gas sweetening unit, simulation, MDEA, power recovery turbine, waste-to-energy.

I. INTRODUCTION

ACCORDING to the Paris agreement, the committed countries established their objectives to implement measures to reduce the amount of greenhouse gas (GHG) emissions in order to fight climate change. The application of these measures in the Chemical Process Industries (CPI) such as Gas Treating Units (GTU) involves the study and employment of alternatives to improve energy performance and reduce emissions in an energy-intensive sector. Often in the CPI, a considerable amount of energy is wasted in pressure control valves, where high-pressure fluids must undergo a pressure reduction [1]. In gas sweetening unit, the high-pressure rich amine stream is expanded to enter the low-pressure amine regenerator, and the lean amine is pumped back to the high-pressure absorber. In these process, a significant amount of energy can be recovered by employing PRT. In these machines, the lost energy in throttling valve, is converted to rotational energy, that can be applied to drive another rotary device such as pump, compressor and generator.

In this case, the waste hydraulic energy for 1 train of Gas Processing Plant is calculated about 320 kW, by considering the conversion efficiencies in PRT and generator, the available energy is about 245 kW. Generally, each commercial GTU consists of four gas trains, hence, the total Waste-to-Energy capacity is nearly 1 MW.

Meisam Moghadasi and Foad Farhani are with the Mechanical Engineering Department, Iranian Research Organization for Science and Technology (IROST), Tehran, Iran (e-mail: moghadasi@irost.org, f.farhani@irost.org).

Hassan Ali Ozgoli is with the Mechanical Engineering Department IROST Sh. Ehsani Rad St., Enqelab St., Parsa Sq., Ahmadabad Mostoufi Rd., Azadegan Highway, Tehran, Iran (corresponding author, phone: +989122449408; e-mail: a.ozgoli@irost.org).

Natural gas, while apparently being a hydrocarbon in nature, contains large amounts of acid gases such as hydrogen sulfide (H_2S) and carbon dioxide (CO_2). The Gas Sweetening Process (GSP) purposes to remove part or all of the acid gas that the natural gas contains for different reasons such as safety reason, satisfaction of sales gas specification and also adjusting CO_2 to allow the sales gas to fit with the required range of gross calorific value (GCV) [2].

The existing GSPs are chemical absorption, physical absorption, physicochemical absorption, physical adsorption, cryogenic fractionation, membrane and direct conversion to sulfur [3].

In chemical absorption, several chemical solvents are available, almost all of them being based on alkanolamine products [4]. Amine gas sweetening is commonly used to remove H_2S and CO_2 from natural gas streams.

The process of commercial gas sweetening unit with MDEA is shown in Fig. 1. The raw gas flows into a drum, and then into a solid filter and a coalescer filter. This way, solid and liquid carry-overs are eliminated. Then, it enters the bottom of the absorber tower and flows upward through the tower. In this section, the raw gas is contacted at high-pressure with the solvent (MDEA aqueous solution), which removes H_2S down to the required specification. The processed sweet gas leaving the absorption tower is then further treated in the dehydration unit to final use.

During the down-flowing, amine absorbs H_2S and CO_2 (acid gases), after that rich amine leaves the bottom of the column. Afterward, it goes into a knock-out drum to separate gases and then temperature rises through the heat exchanger. The rich amine stream is routed to a conventional thermal regeneration column, CO_2 and H_2S are stripped from the rich amine by water vapor generated in a kettle-type reboiler. Then, the lean amine is recycled back to the absorption section. This thermal regeneration section is necessary because it provides an efficient means to break the chemical bonds between CO_2 , H_2S , and amine. This makes it possible to produce a regenerated amine stream with very low residual CO_2 and H_2S content.

The hot wet acid gas from the top of column is cooled in the condenser where water is condensed at the same time. The condensed water, which contains dissolved acid gases, is pumped back under level control from reflux drum via pump to reflux tray. A water make-up is made in the water wash circulation loop. This make-up is of steam condensates quality and can also be made in the reflux drum either by adding steam condensate or by direct steam injection into the

regenerator. In normal operation, this make-up corresponds to the total amount of water required to compensate for the water losses in the unit.

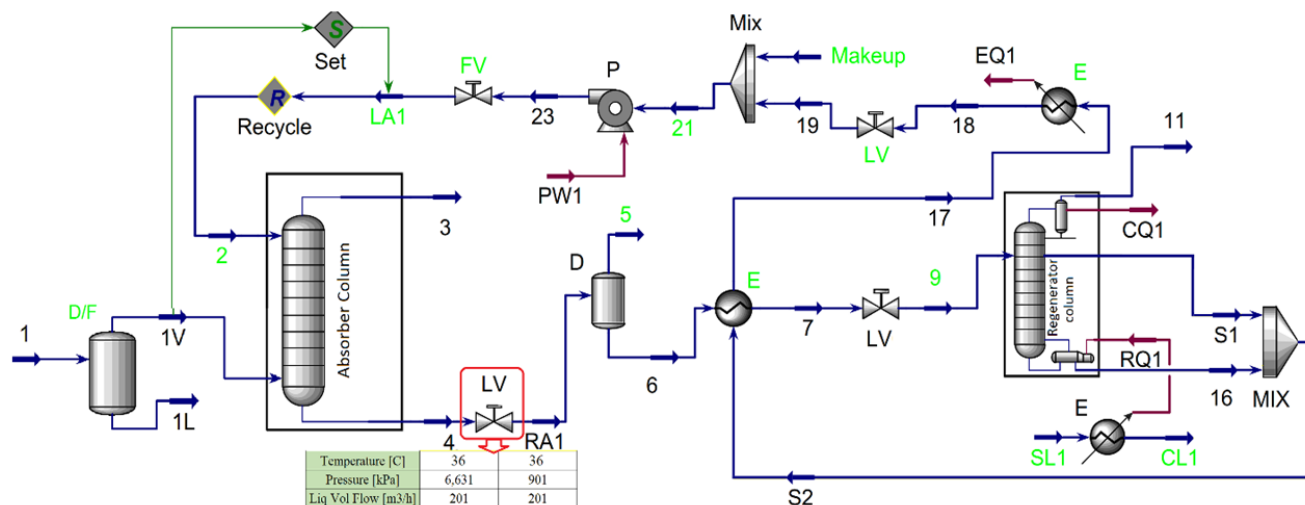

Fig. 1 Process flow diagram for GSP with MDEA solvent by Aspen HYSYS software

A miscellaneous section gathers common facilities such as rich amine flash and heating section, solvent filtration package, drain systems and sump drum, anti-foam make-up and injection package, lean solvent cooling, storage and pumping systems. This selective MDEA process achieves the sweetening of the sour feed gas down to the required H₂S specification, by chemical absorption with an aqueous solution of MDEA. Taking advantage of the slower reaction rate of CO₂ with MDEA, the process can be fitted so as to perform the complete removal of H₂S, while only part of the CO₂ is absorbed in the solvent [5], [6].

A. Chemical Reaction

MDEA with the formula CH₃N(C₂H₄OH)₂, is a tertiary amine. It is used for natural gas sweetening and has received a great deal of attention. MDEA solvent process was developed in order to get a total absorption of hydrogen sulphide and to limit the co-absorption of CO₂ as low as possible. This process is based on the use of MDEA, an industrial amine solvent which is known to have a poor efficiency in CO₂ absorption.

➤ Reaction with H₂S

H₂S reacts immediately with MDEA:

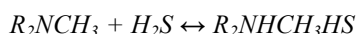

➤ Reaction with CO₂

This reaction has a low reaction rate compared with the very fast reactions between H₂S and MDEA. Knowing the reaction mechanism, it is possible to limit contact to the time just necessary to eliminate all H₂S present in the raw gas but sufficiently short to prevent the CO₂ from reacting completely with the amine solution.

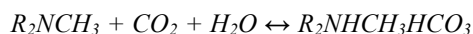

where $R = C_2H_4OH$.

The above reactions are reversible [7], [8].

III. GSP SIMULATION

The total flow rate, pressure, and temperature of feed of the unit (sour gas) is 26,689 kmol/h, 66.1 barg, and 25 °C, respectively. The composition of the sour gas, based on mole fraction, is given in Table I.

TABLE I
COMPOSITION OF SOUR GAS BASED ON MOLE FRACTION

Component	Value	Component	Value
H ₂ O	0.062	C6 cut	0.136
N ₂	3.469	C7 cut	0.079
CO ₂	1.827	C8 cut	0.042
H ₂ S	0.690	C9 cut	0.013
Methane	84.947	C10+	52
Ethane	5.432	COS	3
Propane	2.006	M-Mercaptan	26
iC4	0.371	E-Mercaptan	167
nC4	0.569	PR1 Thiol	43
iC5	0.174	BU1Thiol	7
nC5	0.155	HX1Thiol	2

Typical MDEA concentration ranges are 30%-50% by weight in the aqueous solution and 45% solution was applied in this paper.

A. Simulation Validation

For this purpose, the results of the simulation were compared with industrial data. The flow rate of sweet gas and acid gas, mole fraction of CO₂ and H₂S in the sweet gas and acid gas streams and the pressure of this main streams are listed in Table II. Error is the ratio of the difference between the actual and simulation data to the actual data. The errors in all properties are equal or less than 5%.

B. Simulation Results and Discussion

1) Absorption Column

The contactor is a tray column with valves. It is equipped with 29 valve trays and lean amine can be fed at different column trays (29, 27, 25, 23) depending on Absorber performance. The lean amine solution is fed at the top of the absorber with a 5–20 °C higher temperature than that of the feed gas stream.

TABLE II
 COMPARISON OF THE SIMULATION WITH ACTUAL DATA

Properties	Simulation	Actual	error
Sweat Gas flow (kg/hr)	493,642	493,698	0%
Sweat Gas Pressure (bar)	66.01	65.9	0%
H ₂ S in Sweat Gas (% mol)	0.0000	0.0000	0%
CO ₂ in Sweat Gas (% mol)	0.0080	0.0084	5%
Acid Gas flow (kg/hr)	18,885	18,727	1%
Acid Gas Pressure (bar)	2.11	2.10	1%
H ₂ S in Acid Gas (% mol)	0.3805	0.3751	1%
CO ₂ in Acid Gas (% mol)	0.5700	0.5404	5%

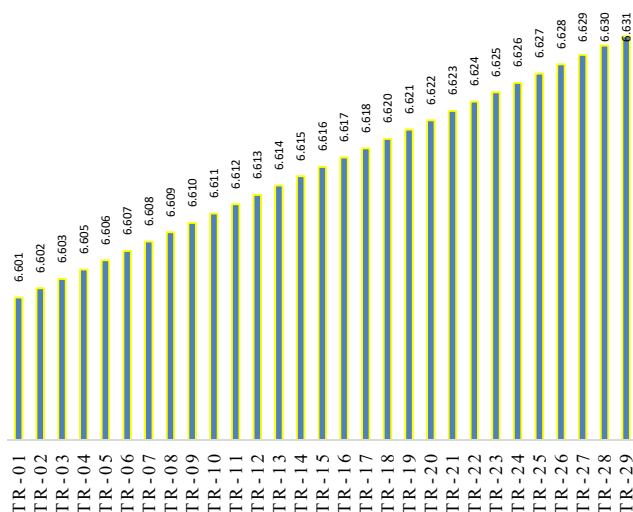

Fig. 2 Pressure profile of absorber column (kPa)

Fig. 2 is plot of the pressure profile. The pressure is linearly increased from the bottom to top of the column. The pressure increasing is approximately constant in each tray. The gas temperature and the gas and liquid velocities all have an effect on the pressure in the absorber.

Fig. 3 shows the temperature profile of column. The reaction between MDEA and sour gas takes place in the liquid phase and the amine temperature increases by the heat releases due to the exothermic reaction. The rich amine transfers its heat to the vapour. Consequently, the vapour temperature increases from the bottom to near the upper part of the absorber where the relatively cold inlet amine decreases the temperature.

Inside the column, mass transfer takes place as the CO₂ and H₂S are absorbed by the aqueous amine. As we gradually move up the column, components CO₂ and H₂S are continuously being transferred from the gas phase to the liquid

phase. Thus, in going up the column, there is a decrease in the total gas flowrate and a decrease in the concentration of CO₂ and H₂S in the gas phase.

Fig. 4 plots the concentration of CO₂ in the liquid phase of the absorber. The mole fraction of CO₂ is almost linearly increased from the top (tray 29) to bottom (tray 01) of the column.

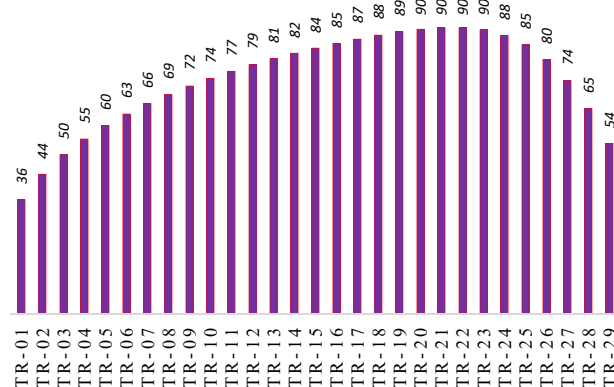

Fig. 3 Temperature profile of absorber column (°C)

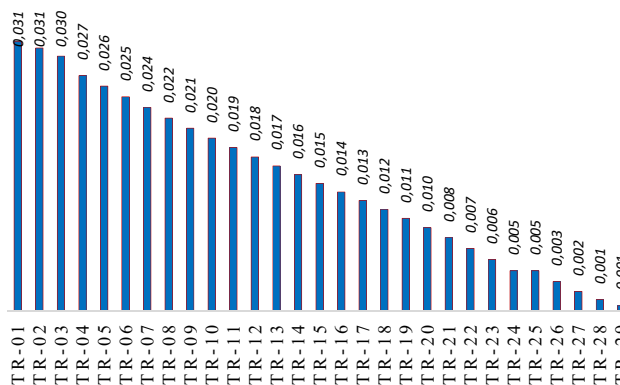

Fig. 4 CO₂ concentration of absorber in liquid phase (mole fraction)

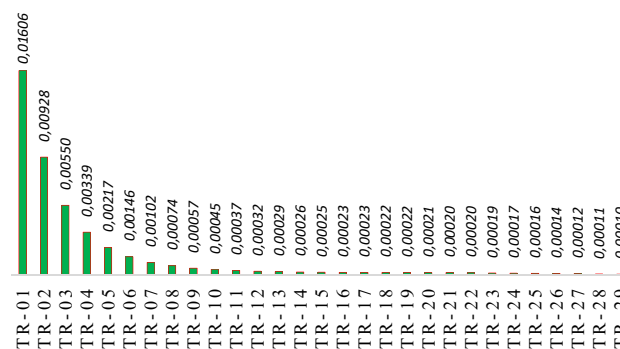

Fig. 5 H₂S concentration of absorber in liquid phase (mole fraction)

The concentration of H₂S in the absorber liquid phase is shown in Fig. 5. The mole fraction of H₂S is rapidly increased in the bottom trays of the column. Rich amine (the amine

solution with acid gases) leaves the bottom of the column.

The CO₂ concentration of absorber in vapour phase is shown in Fig. 6.

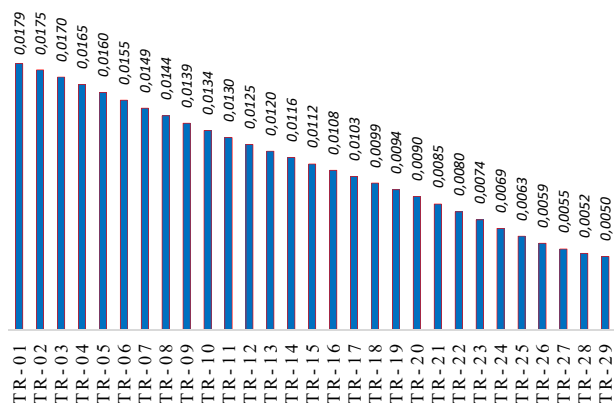

Fig. 6 CO₂ concentration of absorber in vapour phase (mole fraction)

The mole fraction of H₂S in the absorber vapour phase is shown in Fig. 7. The concentration of H₂S drops down to almost zero at the top of the column (clean gas).

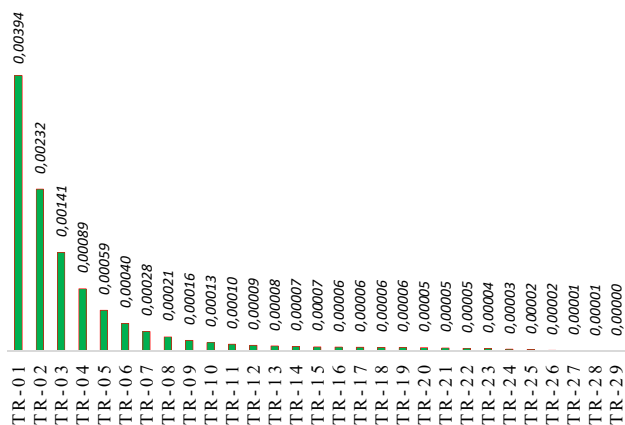

Fig. 7 H₂S concentration of absorber in vapour phase (mole fraction)

2) Regenerator Column

The H₂S and CO₂ contained in the rich amine solution are stripped by counter-current contact with vapour generated in the reboiler (kettle type). Regenerator column is equipped with:

- Two reflux trays (TR-24& 25) in the top of the column to minimise amine carry-over in the regenerator reflux system,
- 23 valve trays for (TR-01 to 23) stripping.

The rich amine stream coming from the flash drum is preheated with hot lean amine in the rich/lean amine exchanger, prior to feeding the top of the regeneration column. The lean amine solution is available at 131 °C at the regenerator bottom. It is cooled down via the lean/rich amine exchanger and lean amine cooler. Then the cold lean amine flows to the storage tank.

The hot wet acid gas from the column overhead is cooled in the air condenser where water is condensed simultaneously.

Temperature and pressure profiles in the regeneration column are shown in Figs. 8 and 9, respectively. During regeneration of the solvent, the absorption reactions are reversed. The reverse reactions are endothermic, meaning heat has to be applied to the solution to liberate the CO₂ and H₂S.

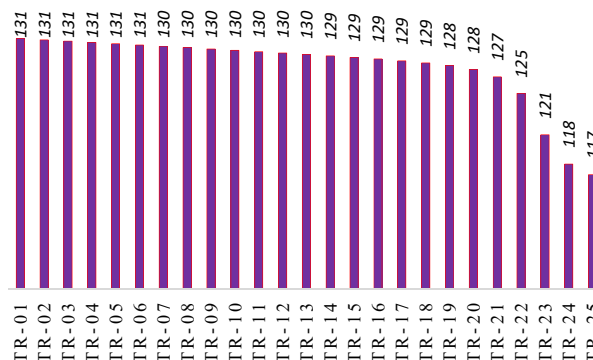

Fig. 8 Temperature profile of regenerator column (°C)

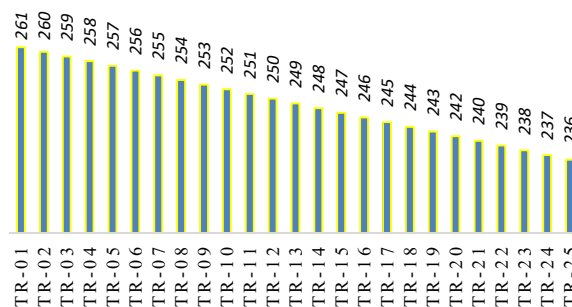

Fig. 9 pressure profile of regenerator column (kPa)

At the top of the regenerator, the acid gases are removed from the amine solution as well as a small percentage of water. Instead, the regenerated solvent (lean) leaves the bottom of the column. The CO₂ and H₂S concentrations in the lean solvent are near zero.

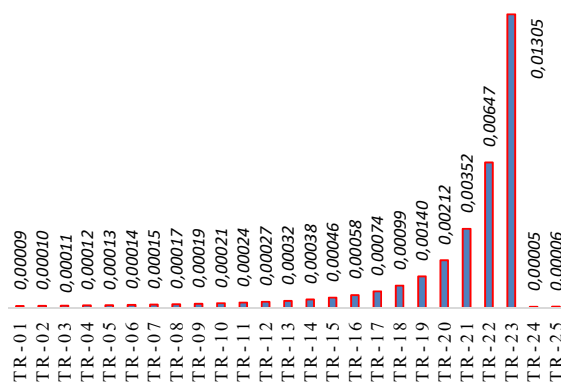

Fig. 10 CO₂ concentration of regenerator in liquid phase (%mol)

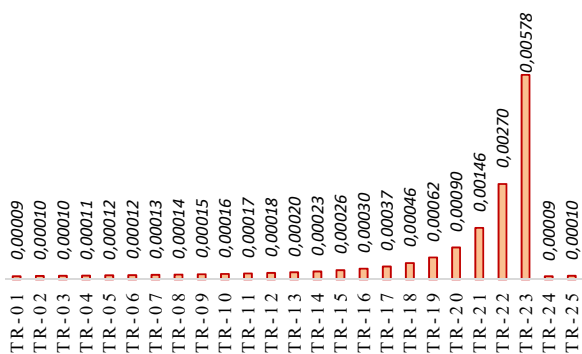

Fig. 11 The H₂S concentration of regenerator in liquid phase (%mol)

Figs. 10 and 11 respectively show the CO₂ and H₂S concentration profiles in the liquid phase for each tray of the regeneration column (stripper).

The CO₂ concentration of regenerator in the vapour phase is shown in Fig. 12.

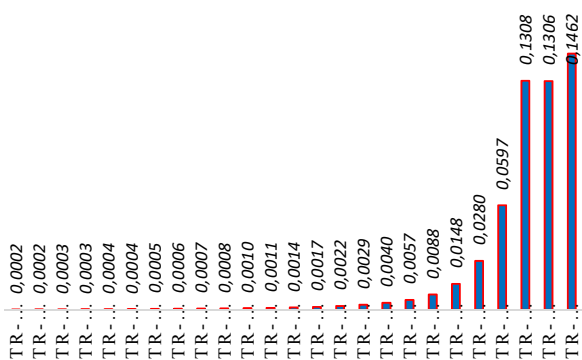

Fig. 12 The CO₂ concentration of regenerator in vapour phase (%mol)

At the top of the column, the concentration of CO₂ and H₂S increase. There is a reflux section where water is supplied to wash the acid gas and steam leaving the stripping section. The mole fraction of H₂S in the stripper vapour phase is shown in Fig. 13.

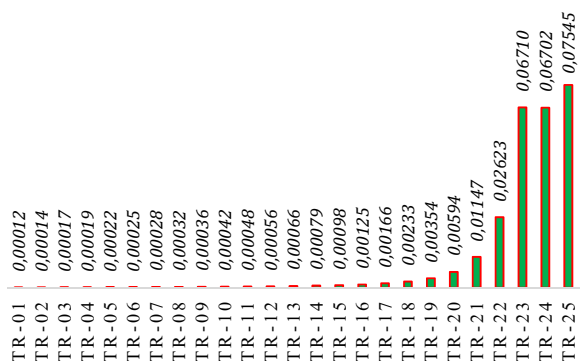

Fig. 13 H₂S concentration of regenerator in vapour phase (mole fraction)

IV. POWER RECOVERY TURBINE

In the PRT, the hydraulic energy of fluid converts into mechanical energy by its pressure reduction which can be applied to do mechanical work on a rotating machine such as pump, compressor, or an electric generator. In essence, PRT is very similar to a centrifugal pump working in reverse flow [9].

A. Calculation of Waste Hydraulic Energy

In the natural GSP, a great deal of energy is dissipated during the depressurization of rich amine, and there is significant energy performance improvement opportunity. The pressurized rich amine exits the bottom of contactor and flashing through the pressure let-down valve (as shown in the Fig. 1) where rich amine loses its energy before going to low-pressure amine flash drum. In this case, the pressure drop across pressure let-down valve is approximately 5730 kPa (831.06 psi). Fig. 14 shows the scope of the PRT, also the scope of its application is specified in the GSP. Accordingly, the minimum capacity for power recovery is about 150 kW.

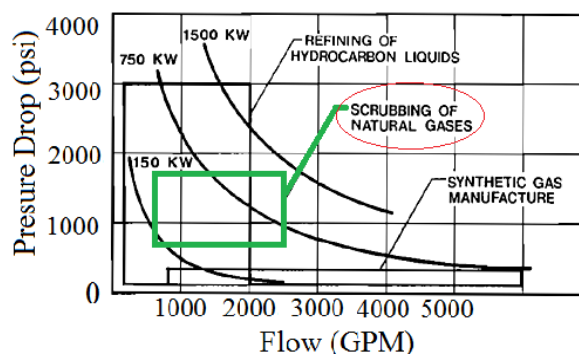

Fig. 14 Scope of the PRT technology

As mentioned, the pressurized rich amine loses a high amount of energy when passing through let-down valve. This pressure reduction can be directly transformed to a quantity of hydraulic energy that is available source for recovery. In this case, the calculated results are given in Table III.

TABLE III
 RESULTS OF WASTE HYDRAULIC ENERGY CALCULATION

Item	Unit	Input data	Calculated
Pin	kPa	6631	-
Pout	kPa	901	-
ΔP	kPa	-	5730
Flow	$\frac{m^3}{h}$	201	-
waste hydraulic power	kW	-	320
PRT Efficiency	%	80	-
PRT output shaft power	kW	-	272

B. Electricity Generation from PRT

In spite the fact that PRT may be used to drive an electric generator, the application as a standalone driver is less common. The simplified process of electricity generation from waste hydraulic energy is shown in Fig. 15.

By considering the efficiency of generator about %90, the capacity of delivering electricity power is approximately 245

kW for each train of gas treating plant.

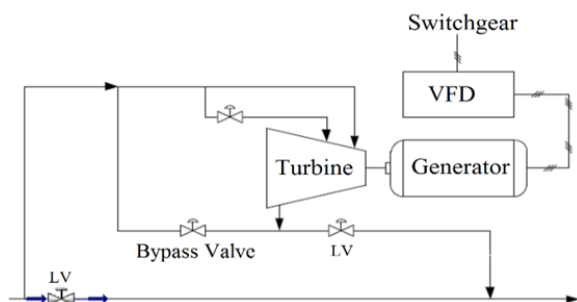

Fig. 15 Schematic of turbine and generator

C. Hydraulic Power Recovery Turbine (HPRT)

A HPRT application is typically used as a secondary driver inline to a primary drive motor and acts as the trim power to the system. A train arrangement may contain a motor as the primary driver, an amine pump, and the HPRT system would add a HPRT, an overrunning clutch, bypass PCV, and shaft. As supplemental power is available, the HPRT and clutch would be engaged and allowed to drive the secondary equipment shaft, thereby reducing the output needed of the primary motor and decreasing electricity consumption [10].

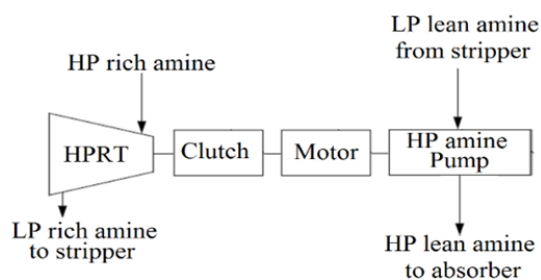

Fig. 16 Schematic of HPRT and amine pump

1) HPRT Key Criteria

HPRT key metrics are given in Table IV, which are efficiency, capital, and operational costs, GHG reduction potential and time to perform engineering and installation [11], [12].

TABLE IV
HPRT KEY CRITERIA

criteria	Comment
Performance	typically, efficiency: from 40% to 80%
Capital cost	Initial investment from \$500k to \$2M
Operational costs	reduce energy cost, includes maintenance costs
Payback period	About two years, by considering saving energy costs and maintenance expenses
Engineering and installation time	Approximately from 6 to 18 months
Environmental considerations	Reduce GHG emissions

2) HPRT Types

HPRTs are often applied in large scale applications and tend to have different operating requirements and characteristics [13]. The four common types of HPRT include:

- Pelton wheel type: this turbine is advisable for high flow stream, where the pressure is let-down from high to almost atmospheric.
- Francis vane type: this type operates at low pressures and high flow streams and is frequently applied in large-scale hydropower stations.
- Water turbine: it is suitable to any application but has limited availability and to perform effectively, requires a large capital investment.
- Radial flow centrifugal pump: a more economical and effective approach involves the use of a radial flow centrifugal pump in reverse to act as a HPRT, that creates a rotational work output.

V. CONCLUSIONS

In the first part of this study, an Aspen HYSYS simulation of an existing commercial GSP using MDEA solution was developed in order to validate its accuracy against plant design data and actual data. The errors in all properties and parameters were equal or less than 5%. Further, temperature and pressure profiles and performance of columns were investigated. In the second part, the validated simulation model in the first part was used to the calculation of waste hydraulic energy of the process. Moreover, electricity generation from PRT and HPRT were discussed.

In conclusion, the waste hydraulic energy of pressure let-down for 1 train of the plant has been calculated about 320 kW. For the first application of waste-to-energy, the capacity of delivering electricity is approximately 1 MW for the total plant. For the second application, annual electricity consumption of total plant is reduced about 8,000 MWh, by deploying secondary drive inline to the amine pump motor, the Pelton wheel type turbine is the best option for this purpose.

NOMENCLATURE

Acronyms	
MDEA	Methyl-Di-Ethanol-Amine
PRT	Power Recovery Turbine
GHG	Greenhouse Gas
CPI	Chemical Process Industry
GTU	Gas Treating Unit
GSP	Gas Sweetening Process
HP	High Pressure
HPRT	Hydraulic Power Recovery Turbine
LV	Let-down Valve
Parameters	
GCV	Gross Calorific Value
kW	Kilowatt
MW	Megawatt
MWh	Megawatt hour
% mol	mole fraction

ACKNOWLEDGMENT

The authors would like to thank the South Pars Gas Complex (SPGC) for providing the data used in this research.

REFERENCES

- [1] Gutierrez, J. P., Ale Ruiz, E. L., Erdmann, E., *Energy requirements, GHG emissions and investment costs in natural gas sweetening processes*, Journal of Natural Gas Science & Engineering (2017), doi:10.1016/j.jngse.2016.12.036.
- [2] Abdolkarim Sharifi, Elham Omidbakhsh Amiri, *Effect of the Tower Type on the Gas Sweetening Process*, Oil & Gas Science and Technology – Rev. IFP Energies nouvelles (2017) 72, 24.
- [3] Tohid Nejad Ghaffar Borhani, Morteza Afkhamipour, Abbas Azarpour, Vahid Akbari, Seyed Hossein Emadi, Zainuddin A. Manan, *Modeling study on CO₂ and H₂S simultaneous removal using MDEA solution*, Journal of Industrial and Engineering Chemistry (2015).
- [4] Meisam Moghadasi, Hossein Ghadamian, Hooman Farzaneh, Mohammad Moghadasi and Hassan Ali Ozgoli, CO₂ capture technical analysis for gas turbine flue gases with complementary cycle assistance including nonlinear mathematical modeling, *Procedia Environmental Sciences* 17 (2013) 648 – 657.
- [5] Wael A. Fouad, Abdallah S. Berrouk, *Using mixed tertiary amines for gas sweetening energy requirement reduction*, Journal of Natural Gas Science and Engineering 11 (2013) 12e17.
- [6] Juan Pablo Gutierrez, Leonel A. Benitez, Elisa L. Ale Ruiz, Eleonora Erdmann, *A sensitivity analysis and a comparison of two simulators performance for the process of natural gas sweetening*, Journal of Natural Gas Science and Engineering 31 (2016) 800e807.
- [7] R. Abdulrahman, I. M. Sebastine, *Natural gas sweetening process simulation and optimization: A case study of Khurmala field in Iraqi Kurdistan region*, Journal of Natural Gas Science and Engineering 14 (2013) 116e120.
- [8] H. A. Ozgoli, H. Ghadamian, R. Roshandel & M. Moghadasi, *Alternative Biomass Fuels Consideration Exergy and Power Analysis for Hybrid System Includes SOFC and GT Integration*, *Energy Sources, Part A: Recovery, Utilization, and Environmental Effects*, 37:1962–1970, 2015.
- [9] Pradeep Bansal, Nick Marshall, *Feasibility of hydraulic power recovery from waste energy in bio-gas scrubbing processes*, *Applied Energy* 87 (2010) 1048–1053.
- [10] Jeremy Martin, Mark Richter, Max Shirazi, *Application of a Hydraulic Turbogenerator in the Acid Gas Removal at a Gas Plant in the Middle East*, Energy Recovery Inc., San Leandro, CA 94577, USA.
- [11] P. Krish, J. Martin and M. Shirazi, *Optimize amine process design using liquid-phase turbochargers*, Energy Recovery Inc., San Leandro, CA 94577, USA.
- [12] The IPIECA website. (Online), *Power Recovery Turbines*, Available: <http://www.ipieca.org/resources/energy-efficiency-solutions/power-and-heat-generation/power-recovery-turbines>.
- [13] The Sulzer website. (Online), *Hydraulic power recovery turbine, Minimize your energy consumption*, Available: <https://www.sulzer.com>.