

Aerodynamic Bicycle Torque Augmentation with a Wells Turbine in Wheels

Tsuyoshi Yamazaki, Etsuo Morishita

Open Science Index, Aerospace and Mechanical Engineering Vol:12, No:3, 2018 publications.waset.org/10009333.pdf

Abstract—Cyclists often run through a crosswind and sometimes we experience the adverse pressure. We came to an idea that Wells turbine can be used as power augmentation device in the crosswind something like sails of a yacht. Wells turbine always rotates in the same direction irrespective of the incoming flow direction, and we use it in the small-scale power generation in the ocean where waves create an oscillating flow. We incorporate the turbine to the wheel of a bike. A commercial device integrates strain gauges in the crank of a bike and transmitted force and torque applied to the pedal of the bike as an e-mail to the driver's mobile phone. We can analyze the unsteady data in a spreadsheet sent from the crank sensor. We run the bike with the crank sensor on the rollers at the exit of a low-speed wind tunnel and analyze the effect of the crosswind to the wheel with a Wells turbine. We also test the aerodynamic characteristics of the turbine separately. Although power gain depends on the flow direction, several Watts increase might be possible by the Wells turbine incorporated to a bike wheel.

Keywords—Aerodynamics, wells turbine, bicycle, wind engineering.

I. INTRODUCTION

MANY people are enjoying cycling these days. Bicycles are so developed and they are very light and easy to handle. Special wheels are used in the competition. A disc is used for the rear wheel while a baton wheel is used for the front wheel. This is because people would like to reduce the aerodynamic drag in the time trial.

While we also ride on a bike, we frequently experience constant cross-wind. Head wind is the worst case and tail wind is very comfortable. A yacht can move upstream against the head wind and this maneuver is called tacking. Although it might be possible to equip a sail to a bike, this is not a practical concept. Wells turbine rotates in one direction irrespective of the incoming flow, and this turbine generates power in an oscillating flow in the ocean [1]-[4]. If we incorporate this turbine to the wheel of a bike, torque can be augmented due to the incoming flow. Because the turbine rotates in one direction, tacking might be possible even for a bike.

In this research, we propose a bike with Wells turbine inside wheels [5], [6]. This is very similar to the baton wheel. Wells turbine is installed not only to reduce the aerodynamic drag, but also to increase the thrust of a bike. We first describe our idea and experiments briefly, and revisit the basic theory of Wells turbine.

Tsuyoshi Yamazaki is graduate student, Department of Mechanical Engineering, Graduate School of Science and Engineering, Meisei University, 2-1-1, Hodokubo, Hino, Tokyo, 191-8506 Japan.

Etsuo Morishita is with Meisei University, 2-1-1, Hodokubo, Hino, Tokyo, 191-8506 Japan (e-mail: etsuo.morishita@meisei-u.ac.jp).

II. BICYCLE WITH WELLS TURBINE

Fig. 1 shows a bicycle of 27 inch with a Wells turbine. In this figure, the turbine is installed in the rear wheel. It is also possible to set the turbine either inside the front wheel or both the wheels.

As the Wells turbine rotates in one direction, the normal component of the wind possibly could drive the bicycle forward. Of course the aerodynamic drag acts on the wheel and the net driving force is not necessarily positive. But in the preferable condition, the bicycle can be driven by the wind. It is quite obvious, a tail wind helps the rider and the turbine accelerates the bike furthermore.

Fig. 2 shows the operating principle of Wells turbine. Although the blade of the turbine is symmetric, it creates the rotational torque once it begins to rotate. This is because the relative flow has an angle of attack, and therefore lift is generated to rotate the blade. Although the efficiency of the turbine of course tends to be lower than the conventional one, the unidirectional nature of the turbine is very attractive to the present application.



Fig. 1 Bicycle with Wells turbine in wheels

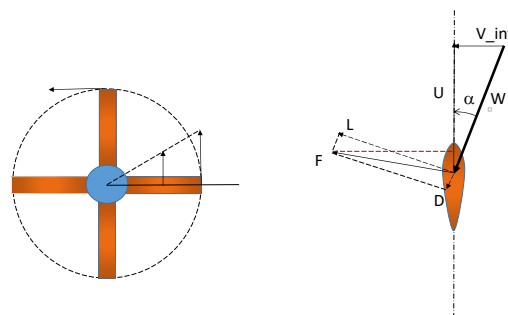

Fig. 2 Wells turbine (D : drag, F : force, L : lift, U : rotational speed, V_{inf} : wind velocity, W : relative velocity, α : angle of attack)

III. BIKE WHEEL EXPERIMENT

Fig. 3 shows the Wells turbine installed to a bike wheel. We

measure the free rotation speed of several different model turbines of 500 mm diameter in the low-speed wind tunnel exit and the result is shown for the NACA airfoils in Fig. 4.

A crank torque sensor, Stages Power Meter New Generation 2-Shimano Ultegra 6800, is available to the bike in Fig. 1, and the unsteady torque is obtained as in Fig. 5. Fig. 5 shows clearly the applied force and the torque by the rider.



Fig. 3 Wells turbine in a wheel

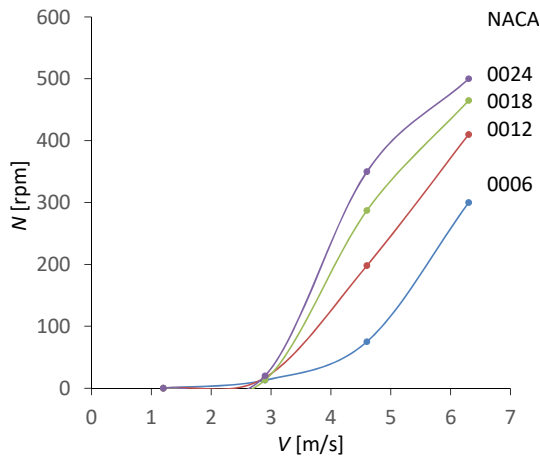

Fig. 4 Model Wells turbine free rotation characteristics (diameter 550 mm)

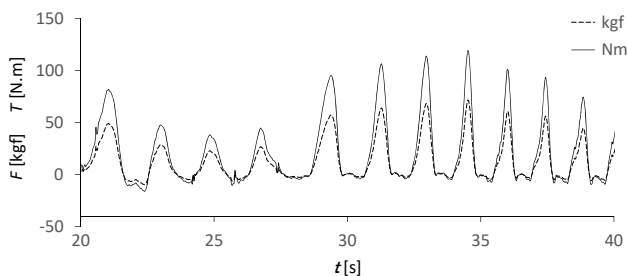

Fig. 5 Crank force and torque

IV. WELLS TURBINE

A. Airfoil Characteristics

Before we proceed to a theoretical modelling of the Wells turbine, it is important to get the aerodynamic characteristics of a symmetric airfoil for the turbine. Fig. 6 shows the experimental results for a two-dimensional NACA0024 airfoil, where C_d is the drag coefficient, C_l the lift coefficient, C_{m0} the moment coefficient around the leading edge. The straight line in Fig.6 shows the theoretical lift coefficient C_{lth} by the lifting line theory. Many studies show that thick airfoils might be better for the Wells turbine application [2]-[4]. One of the reasons might be that self-starting is easy for the thick airfoils.

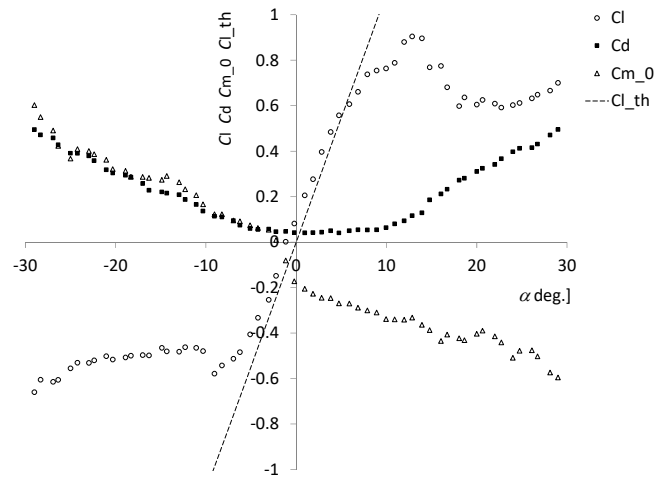

Fig. 6 NACA0024 three-component balance experiment
 $Re = 3.9 \times 10^4$

B. Blade Element Theory

The blade element theory assumes the two-dimensional flow at each radial location of the blade. For the ocean power generation, short blades are used and the blade element theory might be appropriate. Because the theory is simple, three-dimensional effect for the higher aspect ratio is not included. The blade span of a Wells turbine is rather small in the ocean power generation, and we can represent the aerodynamic forces and moment at a particular radius. We can derive the following equations.

$$C_{\theta} \equiv \frac{(L \sin \alpha - D \cos \alpha) r}{\frac{1}{2} \rho V^2 \cdot A \cdot r} = \sigma m_0 \left[1 - \frac{C_D}{m_0} \frac{\sqrt{1 + \phi^2}}{\phi} \right] \quad (1)$$

$$C_A \equiv \frac{L \cos \alpha + D \sin \alpha}{\frac{1}{2} \rho V^2 \cdot A} = \sigma m_0 \left[1 + \frac{C_D}{m_0} \frac{\sqrt{1 + \phi^2}}{\phi} \right] \frac{1}{\phi} \quad (2)$$

$$\eta = \frac{P}{Q\Delta p} = \frac{(L \sin \alpha - D \cos \alpha) r \omega}{(L \cos \alpha + D \sin \alpha) V} = \frac{1 - \frac{C_D}{m_0} \sqrt{1 + \phi^2}}{1 + \frac{C_D}{m_0} \sqrt{1 + \phi^2}} \quad (3)$$

where we define

$$\phi \equiv \frac{V}{U} = \frac{V}{r\omega} = \tan \alpha \quad (4)$$

$$\sigma \equiv \frac{S}{A} \quad (5)$$

$$L \equiv \frac{1}{2} \rho W^2 \cdot C_L \cdot S \quad (6)$$

$$D \equiv \frac{1}{2} \rho W^2 \cdot C_D \cdot S \quad (7)$$

$$W \equiv \sqrt{U^2 + V^2} \quad (8)$$

$$C_L \equiv m_0 \sin \alpha$$

and A is the cross-sectional area, C_A the axial force coefficient, C_D the drag coefficient, C_L the lift coefficient, D the drag, m_0 the lift slope, P the turbine output power, Δp the total pressure drop across the turbine, Q the volumetric flow rate, r the radius, S the total blade area, U the blade rotational velocity, V the flow velocity, W the relative velocity, α the angle of attack, and σ the solidity.

Equations (1)-(3) are examined by comparing to the existing experimental results by Takasaki et al. [4]. The experimental values normalized based on the relative velocity W [4] are transformed to the present definition based on the flow velocity V , i.e. the factor $W^2 / V^2 (= 1 + 1/\phi^2)$ is multiplied to the experimental values.

Fig. 8 shows the torque coefficient C_Q for $\sigma = 0.67$. In the blade element theory, we choose $m_0 = 2\pi$ and $C_D = 0.04$ to fit the experimental data. The theory differs from the experiment at the higher flow coefficient ϕ , possibly due to the constant aerodynamic coefficients assumption in the theory.

Fig. 9 shows the axial force comparison. The blade element theory underestimates the value of C_A . The axial force is derived from the pressure drop Δp in the experiment, while it is directly calculated from the definition in the blade element theory. The experiment might involve other frictional and interferential losses and the pressure loss of the experiment could be higher than that of the theory.

The efficiency prediction by the blade element theory in Fig. 10 is therefore even poorer due to the underestimation of the axial force. It might be better if we can use the experimental aerodynamic coefficient in the blade element theory.

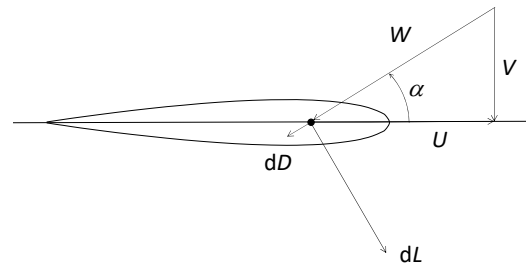

Fig. 7 Airfoil section of Wells turbine

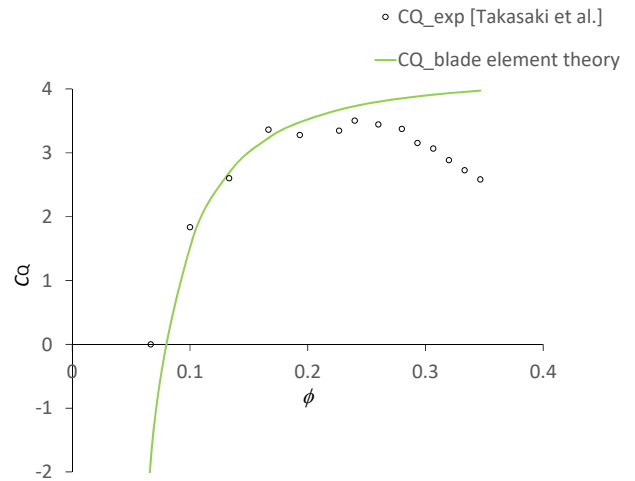

Fig. 8 Torque coefficient C_Q for $\sigma = 0.67$ (blade element theory: $m_0 = 2\pi$, $C_D = 0.04$)

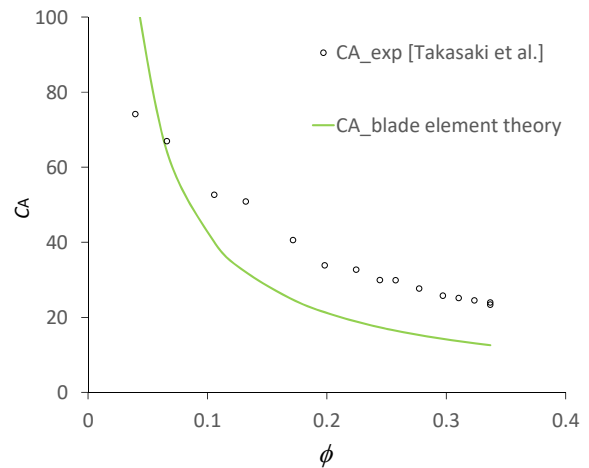

Fig. 9 Axial force coefficient C_A for $\sigma = 0.67$ (blade element theory: $m_0 = 2\pi$, $C_D = 0.04$)

C. Blade Element-Momentum Theory

One of the quick remedies for the three-dimensional turbine problem is the local induced angle of attack derived from the momentum theory of the general turbine, which states that the incoming flow just before the turbine is equal to the average of the upstream and the downstream uniform flows. This momentum change is assumed to be equal to the local blade

axial force. From this assumption, we may get

$$\alpha_i = \frac{\sin \alpha}{1 + 8 \left[\frac{\sigma m_0}{\left(\frac{b}{r} \right)} \right]} \quad (9)$$

where b is the blade span, r the radius, α the local geometrical angle of attack, α_i the local induced angle of attack. By using the local induced angle of attack α_i together with the two-dimensional airfoil characteristics, we can estimate the aerodynamic forces on the blade element at a particular radial location. The total turbine output can be estimated by adding these radial aerodynamic forces and moment.

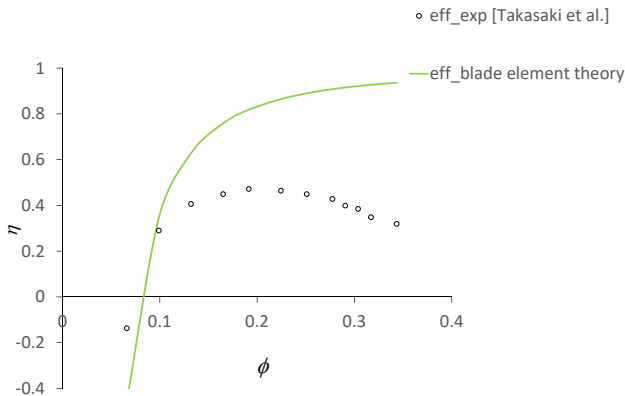

Fig. 10 Efficiency η for $\sigma = 0.67$ (blade element theory:
 $m_0 = 2\pi$, $C_d = 0.04$)

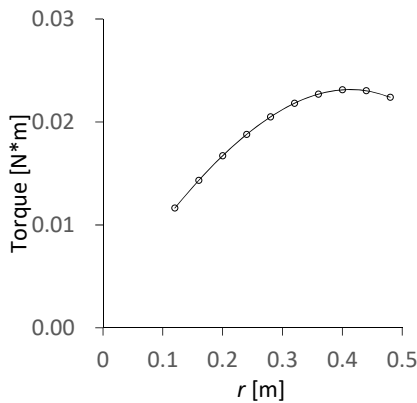

Fig. 11 Wells turbine radial torque distribution
 $N_b = 4$, $r_o = 0.5\text{m}$, $r_i = 0.1\text{m}$, $c=0.1\text{m}$, $V=3\text{m}$, $N=200\text{rpm}$
 $\sigma \approx 0.2$, $m_0 = 0.7 (C_i \equiv m_0 \times 2\pi \sin \alpha)$, $C_d = 0.1$

Fig. 11 shows one of the results of the radial torque distribution where the airfoil sectional drag coefficient is assumed constant for simplicity, and N_b is the number of blades,

r_o the tip radius and r_i the root radius of the blade, respectively.

Fig. 12 shows the performance prediction of the Wells turbine shown in Fig. 11 by changing the rotational speed. The flow coefficient ϕ is defined by the turbine tip speed.

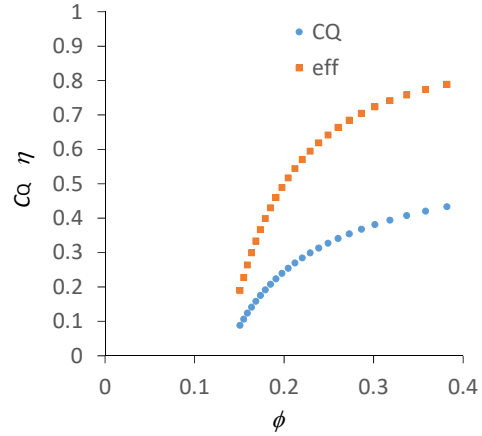

Fig. 12 Performance prediction of Wells turbine
 $N_b = 4$, $r_o / c = 5$, $r_i / c = 1$, $\sigma \approx 0.2$
 $m_0 = 0.7 (C_i \equiv m_0 \times 2\pi \sin \alpha)$, $C_d = 0.1$

V. CONCLUSION

We propose a bicycle with Wells turbine in wheels. Although the power augmentation might be small, it might be possible to get power from the cross wind. The aerodynamic characteristics of the Wells turbine are studied experimentally and analytically. The blade element theory is compared to the experiment. The blade element-momentum theory predicts the radial distribution of the aerodynamic torque along the turbine blade. Several Watts power gain might be possible in the preferable condition.

REFERENCES

- [1] M. Suzuki and C. Arakawa, "CFD Analysis on flow around Wells turbine for wave-power generating system (in Japanese)", Proceedings of the 15th symposium on computational fluid dynamics, E10-2, 2015, pp.1-5.
- [2] M. Inoue, "Wave power generation and Wells turbine (in Japanese)", B. Turbomachinery, Vol.13, No.5, 1985, pp.278-284.
- [3] M. Suzuki, "Characteristics of Wells turbine for wave power generating system and potential theory", Trans. JSME (B), Vol.72, No.715, 2006, pp.678-684.
- [4] K. Takasaki, T. Tsunematsu, M. Takao, M. M. Ashraful Alam and T. Setoguchi, "Wells turbine for wave energy conversion-effect of trailing edge shape-", Int. J. Fluid Machinery and Systems, Vol.9, No.4 2016, pp.307-312.
- [5] T. Yamazaki and E. Morishita, "Aerodynamically assisted bicycle by Wells turbine", Proc. 22nd Sky Sports Symposium 2016, JSASS-2016-6002, pp.5-8.
- [6] T. Yamazaki and E. Morishita, "Crank torque measurement of aerodynamically assisted bicycles by Wells turbine", Proc.23rd Sky Sports Symposium 2017, JSASS-2017-6002, pp.6-9.