

# Stability Analysis of a Low Power Wind Turbine for the Simultaneous Generation of Energy through Two Electric Generators

Daniel Icaza, Federico Córdova, Christian Castro, Fernando Icaza, Juan Portoviejo

**Abstract**—In this article, the mathematical model is presented, and simulations were carried out using specialized software such as MATLAB before the construction of a 900-W wind turbine. The present study was conducted with the intention of taking advantage of the rotation of the blades of the wind generator after going through a process of amplification of speed by means of a system of gears to finally mechanically couple two electric generators of similar characteristics. This coupling allows generating a maximum voltage of 6 V in DC for each generator and putting in series the 12 V DC is achieved, which is later stored in batteries and used when the user requires it. Laboratory tests were made to verify the level of power generation produced based on the wind speed at the entrance of the blades.

**Keywords**—Smart grids, wind turbine, modeling, renewable energy, robust control.

## I. INTRODUCTION

CURRENTLY, small power wind turbines can greatly contribute to the energy demand of households in our country, especially mainly in rural areas where the implementation of this system becomes interesting and convenient for users since in these places the environmental conditions and the wind are very frequent, which will allow the wind turbine to remain in operation most of the time, consequently delivering a fairly regular production of energy [1].

We are forced to look for new alternatives of electrical energy for the increase of the electrical consumption. An energy that has a constantly rising price becomes prohibitive for the most deprived classes [1].

The homemade wind turbines in recent years have been taking a lot of interest from the population, because this system has allowed users to significantly reduce the energy consumption schedules.

Renewable energy becomes inevitable today, only 12.9 percent of the energy in the world is alternative. But, according to the Intergovernmental Panel on Climate Change (IPCC), it should meet 80% of global needs by 2050. The International Renewable Energy Agency says that the

Daniel Icaza and Federico Córdova are with the Research Group GIRVyP, University Catholic of Cuenca, Cuenca, Ecuador (e-mail: dicazaa@ucacue.edu.ec, ncordovag@ucacue.edu.ec).

Christian Castro and Juan Portoviejo are with the School of Electrical Engineering, University Catholic of Cuenca, Cuenca, Ecuador (e-mail: crismanuastro02@gmail.com, jpportob@gmail.com).

Fernando Icaza is with the Student Development Area, De la Salle Cuenca, Cuenca, Ecuador (e-mail: diaelectrico@hotmail.com).

development of the renewable energy sector is inevitable, as it will have to play a role in sustainability. The idea is that its use can be multiplied by 20. Here, there are two reasons: to take advantage of those resources that seem inexhaustible, such as the strength of the sun, which will possibly be exhausted within 5,000 years and to reduce the emission of greenhouse gases.

Electric power through wind generation progressed unstoppably as of the 20<sup>th</sup> century, in some countries more than in others. At the level of South America, this system is being implemented in Argentina, Brazil, Colombia, and Peru.

In Ecuador, renewable energies have also been considered a transcendental part of the National Plan for Good Living, PNBV, where the rural population is directly incorporated, which, in a good proportion, does not have access to distribution lines or, at the same time, would be happy to host this type of autonomous energy sources in several homes. In Ecuador, these sources of renewable energy have not yet been exploited, and unfortunately, in several places, it is still planned to provide energy based on diesel or gasoline generators.

The architecture of the wind turbine requires the use of appropriate and strategic control, which guarantees the optimal integration of the renewable source in the network [1]-[4]. For example, a broad control method used is based on the variable structure of the generation system. As shown in [5], [6], the aim is to achieve a rapid dynamic in the control and also to reduce the uncertainties introduced by load variations. In addition, it must be verified that the mechanical torque is sufficiently capable of generating power to the two generators coupled to the output shaft and has sufficient control and simple regulations [11]-[19].

## II. SIMPLIFIED MATHEMATICAL MODEL

$$V_i(t) = K_i \omega_i(t) \quad (1)$$

$$V_i(s) = K_i \omega_i(s) \quad (2)$$

$$V_x(t) = R_x i_f + L_x \frac{di_f}{dt} \quad (3)$$

$$V_x(s) = (R_x + sL_x)I_f(s) \quad (4)$$

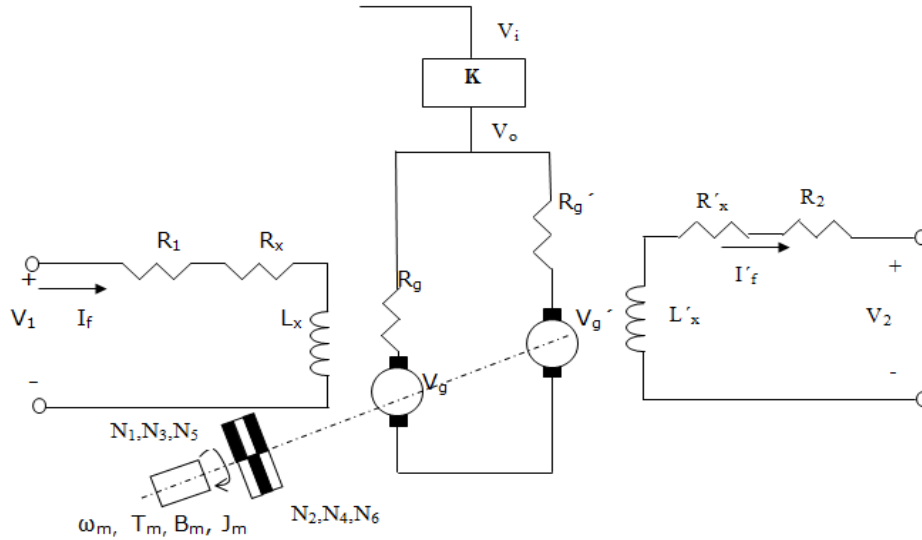

Fig. 1 Simplified mathematical model of the wind turbine where:  $R_g = R'_g$  = Resistance of electric generator,  $V_g = V'_g$  Electromotive force generated,  $K$  = Controller to be selected,  $E_i$  = Input voltage to the controller,  $V_o$  = Output voltage to the controller,  $\omega_g$  = Angular speed of entry to electric generators,  $\omega_m$  = Angular speed of entrance to the wind turbine,  $R_x, L_x = R_x, L_x$  = Impedance related to the stator,  $V_1 = V_2$  = Utility voltage max. 6V,  $R_1 = R_2$  = Input resistance to the stator,  $N_1 = N_3 = N_5$  = Conductive cogwheels,  $N_2 = N_4 = N_6$  = Driven cogwheels,  $K_s$  = Sensor constant of max. speed,  $K_t$  = Proportionality constant of electric generation

$$V_g(t) = K_g i_f(t) \quad (5) \quad J_{eq} = J_m + \left( \frac{N_1 N_3 N_5}{N_2 N_4 N_6} \right)^2 J_L \quad (16)$$

$$V_g(s) = K_g I_f(s) \quad (6)$$

With reference to generator 2, we have:

$$V_g(t) = R_g i_a + V_o(t) + K_c V_i(t) \quad (7)$$

$$V'_x(s) = (R'_x + sL'_x) I'_f(s) \quad (17)$$

$$V_g(s) - V_o(s) = R_g I_a(s) + K_c V_i(s) \quad (8)$$

$$V'_g(s) = K'_g I'_f(s) \quad (18)$$

$$V_1(t) = R_1 i_f(t) \quad (9)$$

$$V'_g(s) - V_o(s) = R'_g I'_a(s) + K_c V_i(s) \quad (19)$$

$$V_1(s) = R_1 i_f(s) \quad (10)$$

$$V_2(s) = R_2 i'_f(s) \quad (20)$$

$$T_m(t) = T_L(t) + T_e^1(t) \quad (11)$$

Below is the block diagram of the wind generator:  
 Let us consider that;

$$T_e^1(t) = - \frac{N_1 N_3 N_5}{N_2 N_4 N_6} T_e(s) \quad (12)$$

$$V_T(t) = V_1(t) + V_2(t)$$

$$V_T(s) = V_1(s) + V_2(s)$$

$$T_L(t) = J_{eq} \frac{d\omega_m}{dt} + B_{eq} \omega_m \quad (13)$$

where  $V_T(s)$  is the total voltage generated in the terminals of the two electric generators, and it does not exceed 12 V DC.

$$T_L(s) = (B_{eq} + J_{eq} s) \omega_m(s) \quad (14)$$

### III. TRANSFER FUNCTION

Using the principles of block reduction to feedback systems related to an output  $Y(s)$  and input  $X(s)$ , we quote [1]:

$$B_{eq} = B_m + \left( \frac{N_1 N_3 N_5}{N_2 N_4 N_6} \right)^2 B_L \quad (15)$$

$$\frac{Y(s)}{X(s)} = \frac{G(s)}{1 + G(s)H(s)} \quad (21)$$

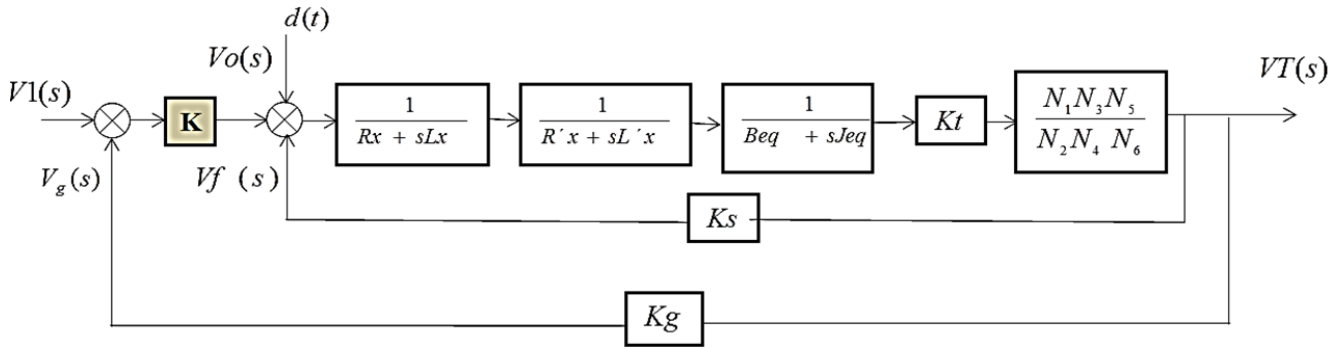

Fig. 2 Block diagram of the wind turbine

Applying (21) to our system [2]-[5] first between  $V_f(s)$  and  $V_T(s)$ , we propose below:

$$\frac{V_f(s)}{V_T(s)} = \frac{\frac{1}{R_x + sL_x} \frac{1}{R'_x + sL'_x} \frac{1}{B_{eq} + J_{eq}s} K_t \frac{N_1 N_3 N_5}{N_2 N_4 N_6}}{1 + K_s * \frac{1}{R_x + sL_x} \frac{1}{R'_x + sL'_x} \frac{1}{(B_{eq} + J_{eq}s)} K_t \frac{N_1 N_3 N_5}{N_2 N_4 N_6}}$$

Organizing terms, we have (22)

$$\frac{V_f(s)}{V_T(s)} = \frac{K_t N_1 N_3 N_5}{N_2 N_4 N_6 (R_x + sL_x)(R'_x + sL'_x)(B_{eq} + J_{eq}s) + K_s K_t N_1 N_3 N_5} \quad (22)$$

Finally applying (21) between the output  $V_f(s)$  and the input  $V_1(s)$ , we obtain the transfer function (23):

$$\frac{V_f(s)}{V_1(s)} = \frac{K_t N_1 N_3 N_5 [K]}{N_2 N_4 N_6 (R_x + sL_x)(R'_x + sL'_x)(B_{eq} + J_{eq}s) + K_s K_t N_1 N_3 N_5 + [K] K_t N_1 N_3 N_5} \quad (23)$$

Parameters:

- $N_1, N_3, N_5 = 80$
- $N_2, N_4, N_6 = 35$
- $L_x = L'_x = 0.2H$
- $R_x = R'_x = 5\Omega$
- $K_s = K_g = 1$
- $K_t = 1 \text{ V/rad/s}$
- $B_{eq} = 0.3 \text{ N-m/rad/s}$
- $J_{eq} = 1 \text{ kg-m}^2$

$$\frac{V_f(s)}{V_1(s)} = \frac{51200[K]}{[428735 + 0.2s)(5 + 0.2s)(0.3 + s) + 1]s + [K]} \quad (24)$$

Organizing terms.

$$V_f(t = \infty) = \lim_{s \rightarrow 0} s V_f(s) = \lim_{s \rightarrow 0} \frac{K_p s + K_I}{0,48s^4 + 24,144s^3 + 307,2s^2 + K_p s + 91 + K_I} = \frac{K_I}{91 + K_I}$$

The characteristic equation is:

$$0,48s^4 + 24,144s^3 + 307,2s^2 + K_p s + 91 + K_I = 0$$

$$\frac{V_T(s)}{V_i(s)} = \frac{[K]}{[12(5 + 0.2s)(5 + 0.2s)(0.3 + s) + 1] + 0,000019[K]} \quad (25)$$

Evaluating (20)

$$\frac{V_T(s)}{V_i(s)} = \frac{K}{0,48s^3 + 24,144s^2 + 307,2s + 91 + 0,00019K} \quad (26)$$

Taking into consideration;

$$V_i(s) = 12 \quad (27)$$

$$V_T(s) = \frac{K}{0,48s^3 + 24,144s^2 + 307,2s + 91 + 0,00019K} 12$$

$D(s)$  = Possible disturbance of kinetic or mechanical nature we start from (22).

$$\frac{V_f(s)}{V_T(s)} = \frac{1}{0,48s^3 + 24,144s^2 + 307,2s + 90 + 0,000019}$$

Taking the transfer function (26), we must now determine the appropriate driver, so we perform the following analyzes:

We test with different controllers, and the one that manages to satisfy is a  $[PI]$  for  $[K] = K_p + \frac{K_I}{s}$

$$\frac{V_T(s)}{V_i(s)} = \frac{K_p + \frac{K_I}{s}}{0,48s^3 + 24,144s^2 + 307,2s + 91 + 0,00019(K_p + \frac{K_I}{s})} \quad (28)$$

$$\frac{V_T(s)}{V_i(s)} = \frac{K_p + \frac{K_I}{s}}{0,48s^3 + 24,144s^2 + 307,2s + 91 + (K_p + \frac{K_I}{s})}$$

It satisfies the stability of the system since all the coefficients of the equation are different from zero [1]. Therefore, we select a  $[PI]$ .

With values of  $K_p = 0.5$  and  $K_I = 0.5$ , the transfer function (28) is finally evaluated:

$$\frac{V_r(s)}{V_i(s)} = \frac{0,5s + 0,5}{0,48s^4 + 24,144s^3 + 307,2s^2 + 91,5s + 0,5} \quad (29)$$

*Graph of Stability of the System*

Starting from (25) before a step input, we obtain Fig. 4 in MATLAB.

When observing Fig. 4, we see that the system stabilizes in the 12 V, according to the design of the wind turbine with the wind speed as constant as possible and with the operation of the two simultaneous electric generators.

As shown in Fig. 5, an analysis is made in the frequency domain starting from the transfer function and analyzing its denominator in function of  $j\omega$ , since the graph does not enclose the point  $-1 + j0$  the system is stable in concordance with Fig. 3 where the LGR is represented.

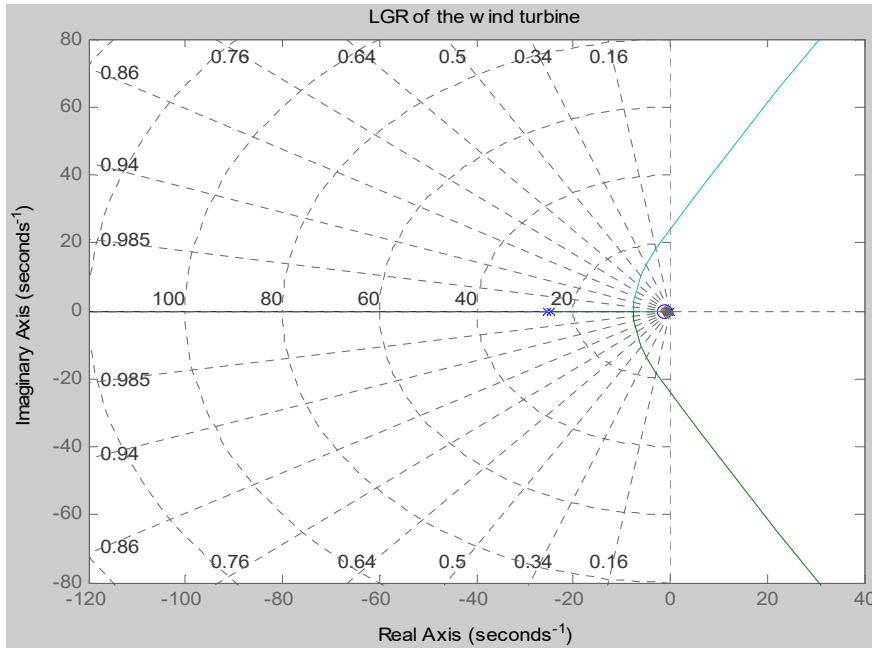

Fig. 3 Location of the LGR of the wind turbine

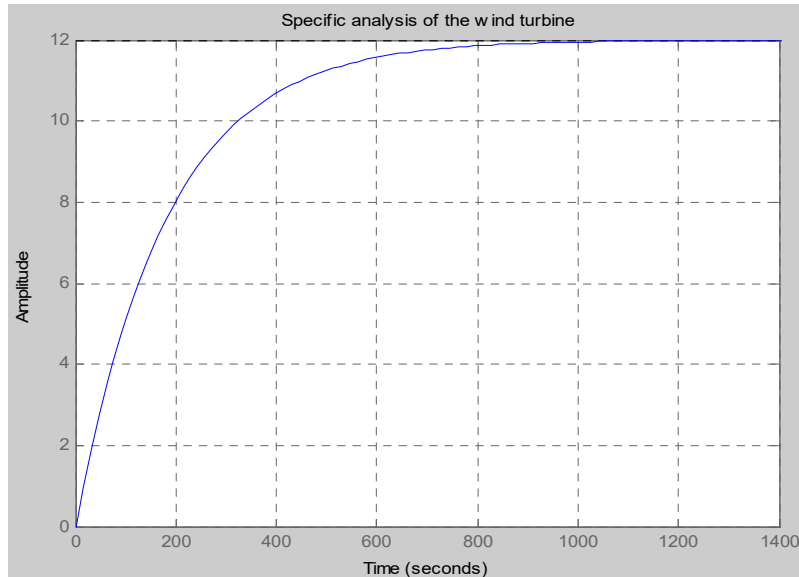

Fig. 4 Response to the impulse of the wind turbine

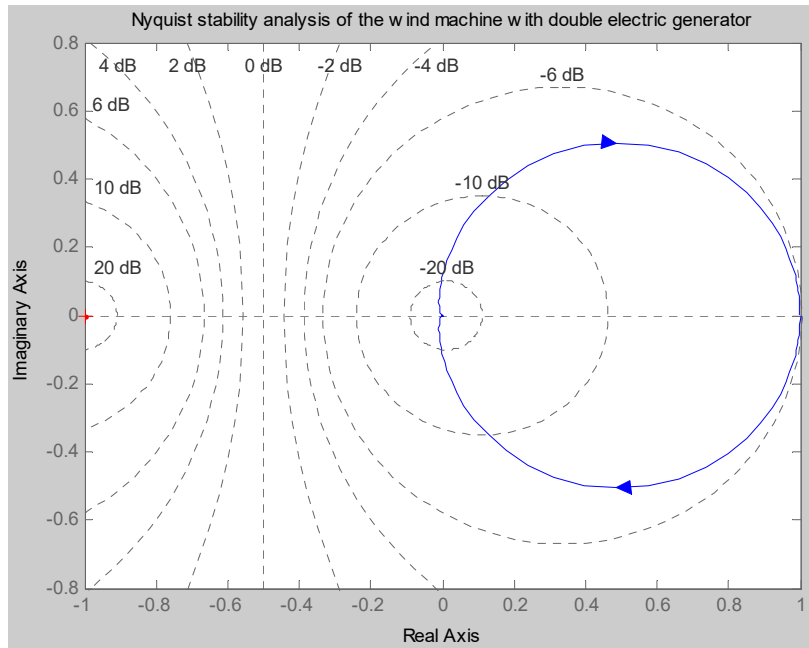

Fig. 5 Nyquist graph for the wind machine with double electric generator

#### IV. STUDY CASE

##### A. Description

In this study, we seek to experience the effects of coupling the two electric generators to the secondary output axis of the multiplication box. With this experimentation, we seek to determine the degree of incidence in the electrical generation with the degree of mechanical effort that is exerted to produce electricity in low power turbines. This analysis seeks to make a design according to the established parameters according to the mathematical model [6]-[9]. We also proceeded to build a wind turbine prototype with the respective parts and pieces, taking into account the outstanding parameters for obtaining the transfer function described according to the mathematical relationship (29) and shown in Fig. 3 by analyzing the locus of the roots in the complex plane.



Fig. 6 Prototype built to perform performance tests

It should be noted that, in the design of the wind turbine, there are many aspects to be taken into account and especially in relation to structural calculation, but the reason for this study refers to the influence that exists when placing two electric generators to the secondary axis.

It is important that each of the main elements that constitute the wind turbine must be designed mechanically, taking into account the efforts to which the wind turbine is subjected, its detail in depth is not the case of this article, but it is important to mention.

After its construction, the operation tests were performed as shown in Fig. 7. For this purpose, we rely on the defined wind energy conversion formulas [7]-[10] as follows:

The power of the turbine is given by [10], [11];

$$P_T = \frac{1}{2} * C_p * \rho_{air} * A * v^3 * \eta_{aer} \quad (30)$$

where  $P_T$  is the Power produced by the sweeping of the blades per unit area,  $C_p$  is the Betz coefficient,  $\rho_{air}$  is the density of the air,  $A$  is the area swept by the blades of the wind turbine, and  $v$  is the speed of the turbine.

- $A = 1,56\pi \text{ m}^2$
- $C_p = 0.5$
- $\rho_{air} = 1.01 \text{ kg.m}^{-3}$
- $\eta_{aer} = 0.55$

Figs. 7 and 8 show that, when a single electric generator is installed, the generation speed is 2 m/s, progressively increasing the generation of energy as a function of speed to the point that, starting at 10.5 m/s, achieves the maximum power of generation of 600 W. Then, we proceeded to install the other electric generator similar to the first and we determined that, at very low speeds, it is not possible to start

generating energy because it requires a higher torque at the entrance to the turbine to overcome the inertia of the two rotors of the generators, once it is achieved that there is sufficient rotation of the rotors, it is observed that, at 3.2 m/s,

energy is scarcely generated, but when sufficiently high speeds are reached it is possible to generate energy up to 900 W. Was the maximum and constant value from 10 m/s.

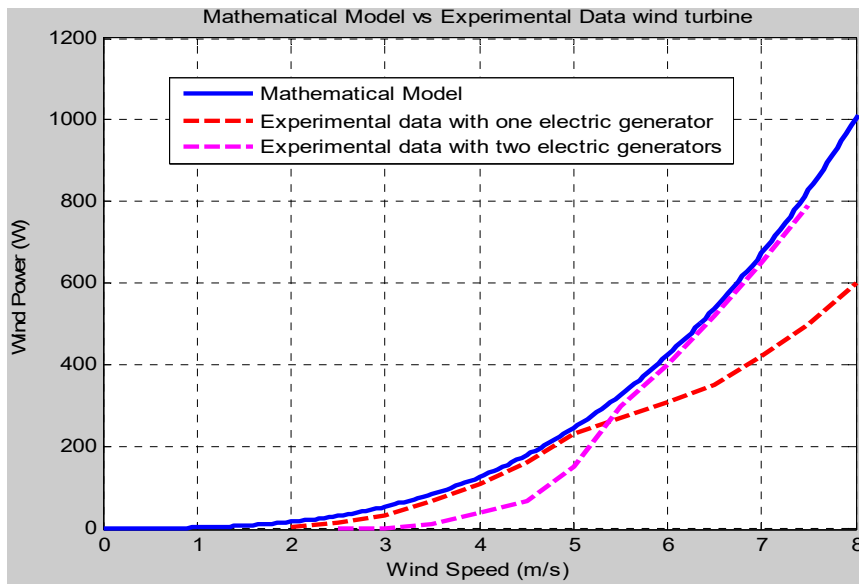

Fig. 7 Comparative curves between the theoretical mathematical model and the experimental curves when

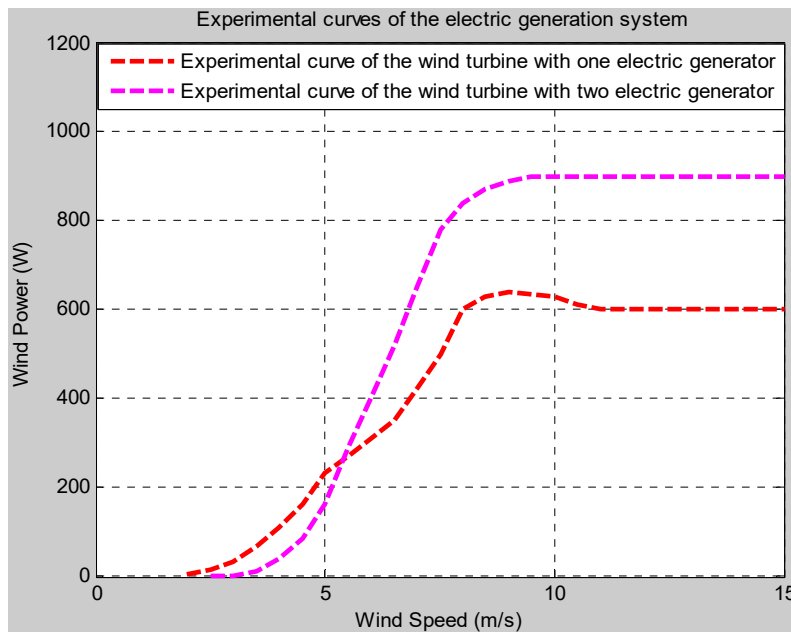

Fig. 8 Stabilized curves of power - speed with one and two electric generators

It is important to indicate that the speed multiplication box must be as calibrated as possible, since if there is a significant imbalance it is very likely that the turbine will stop completely when the two generators are installed. The material of the cogwheels is suggested to be helical tooth grinder as it prevents excessive noise and movements are as constant as possible with a height of teeth around 0.5 cm that was used for this experiment.

## V. CONCLUSIONS

The mathematical model used for the construction of the wind turbine was very efficient, and therefore, the final results were very positive when performing field tests.

This research has used a good part of resources but now having this experience it is even possible to make substantial improvements, and of course, the mathematical model can be improved much more by including other variables and input values.

The installation of wind turbines with dual cogeneration as discussed in this article is possible in low-power wind turbines provided that the wind speed levels are consistently higher than 4 m/s, if possible in several locations including there are winds that are much higher and can be used to a great extent.

As it was analyzed in Fig. 7, if it is not possible to have high wind speeds in a locality, it is not recommended to use a windmill with a double electric generator, one can only be of greater benefit since the energy generated is low scale it can be stored in batteries for the opportune moments that the user considers. On this occasion, an impeller with 2.5 m diameter from blade to blade was used, which may be the reason for another investigation to extend the length of the blades and verify how much benefit it can bring.

The important thing is that despite being a machine quite small in size it is possible to generate power either with one or two generators as has been the motivation for this case, no doubt that this type of wind turbines can be of considerable utility in remote locations.

The generation of energy is available in direct current but we can transform it into alternating current through an inverter equipment.

#### VI. GRATITUDE

We thank the Catholic University of Cuenca for giving us the opportunity to promote this research in the Renewable Energy Area.

#### REFERENCES

- [1] Hattuhiko Ogata, "Ingeniería de Control Moderna". University of Minnesota. Prentice Hall, Tercera edición. 1988.
- [2] R. V. Basavaraj Shivaputrappa Shalavadi, Udaykumar R Yaragatti, "Modelling and Analysis of a Standalone PV/Micro Turbine/ Ultra Capacitor Hybrid System," *International Journal of Renewable Energy Research-IJRER*, vol. Vol 6, 2016.
- [3] D Icaza, A Pauta, G Saguay, F Solis" Control System for Less than Wind Turbines 1500W," *Journal of Technology Innovations in Renewable Energy*, 2016 DOI: <http://dx.doi.org/10.6000/1929-6002.2016.05.03.3>
- [4] N. A. O. Victor Omondi Okinda, "Modeling, Simulation and Optimal Sizing of a Hybrid Wind, Solar PV Power System in Northern Kenya," *International Journal of Renewable Energy Research-IJRER*, vol. Vol 6, 2016.
- [5] Y. Zhu, M. Cheng, Q. Wang "SM-MRAS Based Sensorless MPPT Control for Dual Power Flow Wind Energy Conversion System", 4th International Conference on Renewable Energy Research and Applications (ICRERA), Palermo, Italy, 22-25 Nov 2015, pp. 296-304.
- [6] M. Abdollahi, J. I. Candela, J. Rocabert, R. S. Munoz-Aguilar and J. R. Hermoso, "Improving long line stability by integrating renewables using static synchronous generators", *5th ICRERA Conference*, Birmingham, pp. 512-517, 20-23 November, 2016.
- [7] Binayak, B., Shiva, R. P., Kyung-Tae L., Sung-Hoon A., "Mathematical Modeling of Hybrid Renewable Energy System: A Review on Small Hydro-Solar-Wind Power Generation", *International Journal of Precision engineering and Manufacturing-green Technology*, Vol. 1, No 2, pp. 157-173, 2014.
- [8] Farshid Mostofi, Hossein Shayeghi, "Feasibility and Optimal Reliable Design of Renewable Hybrid Energy System for Rural Electrification in Iran," *International Journal of Renewable Energy Research*, Vol. 2, No. 4, 2012.
- [9] Castillo, A, Villada, F., Valencia, J. A., "Diseño multiobjetivo de un sistema híbrido eólico-solar con baterías para zonas no interconectadas", *Universidad de Antioquia, Tecnura* Vol. 18, Num 39 pp. 77- 93, Enero – Marzo 2014.
- [10] Icaza D. et al. Modeling and simulation of a hybrid system solar panel

- and wind turbine in the locality of Molleturo in Ecuador. ICRERA 2017. San Diego CA USA pp 620-625. DOI: 10.1109/ICRERA.2017.8191134.
- [11] W. Alharbi and K. Bhattacharya, Demand response and energy storage in MV islanded microgrids for high penetration of renewables, in 2013 IEEE Electrical Power & Energy Conference, 2013, pp. 16.
  - [12] D. Paire and A. Miraoui, Power management strategies for microgrid-A short review, in 2013 IEEE Industry Applications Society Annual Meeting, 2013, pp. 19.
  - [13] E. E. Galapagos, "Indicadores de Confiabilidad," *Dirección de Planificación* 2015.
  - [14] Angulo, C.; Godo, L. Modeling problem transformations based on data complexity. *Frontiers in Artificial Intelligence and Applications*, 2007, p. 133.
  - [15] Alegre E, Alaiz-Rodríguez R, Barreiro J, Ruiz J. Use of contour signatures and classification methods to optimize the tool life in metal machining. *Estonian Journal of Engineering*. 2009 Mar 1;15(1).
  - [16] Bayindir, Ramazan, et al. A comprehensive study on microgrid technology. *International Journal of Renewable Energy Research*, 2014, vol. 4, no 4, p. 1094-1107.
  - [17] Icaza D., Modeling, simulation and construction of the D-ICAZA-A1 wind turbine destined for the rural areas of Ecuador. *Innovative Smart Grid Technologies Conference - Latin America (ISGT Latin America)*, 2017 IEEE PES. Quito 2017/12/4 DOI: 10.1109/ISGT-LA.2017.8126742.
  - [18] Icaza D. Sami S., "Modeling, Simulation and Stability Analysis Using MATLAB of a Hybrid System Solar Panel and Wind Turbine in The Locality of Puntahacienda-Quingeo In Ecuador", *International Journal of Management and sustainability*, 2018 vol. 7, No 1, pp 1-24 ISSN(e): 2306-0662. ISSN(p): 2306-9856. DOI: 10.18488/journal.11.2018.71.1.24.
  - [19] Icaza D., Conce H., Flores P., Conce F., "Dimensioning of the main mechanical elements and final assembly of the DIAWIND-A2 wind turbine", 2017 CHILEAN Conference on Electrical, Electronics Engineering, Information and Communication Technologies (CHILECON), DOI: 10.1109/CHILECON.2017.8229551.