

Steel Dust as a Coating Agent for Iron Ore Pellets at Ironmaking

M. Bahgat, H. Hanafy, H. Al-Tassan

Abstract—Cluster formation is an essential phenomenon during direct reduction processes at shaft furnaces. Decreasing the reducing temperature to avoid this problem can cause a significant drop in throughput. In order to prevent sticking of pellets, a coating material basically inactive under the reducing conditions prevailing in the shaft furnace, should be applied to cover the outer layer of the pellets. In the present work, steel dust is used as coating material for iron ore pellets to explore dust coating effectiveness and determines the best coating conditions. Steel dust coating is applied for iron ore pellets in various concentrations. Dust slurry concentrations of 5.0-30% were used to have a coated steel dust amount of 1.0-5.0 kg per ton iron ore. Coated pellets with various concentrations were reduced isothermally in weight loss technique with simulated gas mixture to the composition of reducing gases at shaft furnaces. The influences of various coating conditions on the reduction behavior and the morphology were studied. The optimum reduced samples were comparatively applied for sticking index measurement. It was found that the optimized steel dust coating condition that achieve higher reducibility with lower sticking index was 30% steel dust slurry concentration with 3.0 kg steel dust/ton ore.

Keywords—Ironmaking, coating, steel dust, reduction.

I. INTRODUCTION

IN the past few decades, direct reduction of iron ores has become an important step in ironmaking. Over the years, several direct reduction processes, ranging from those using ore fines to those using lump ores and pellets, have been developed. Some of these processes use natural gas as fuel reductant, whereas the others are based on coal. However, more than 90% of direct reduced iron (DRI) produced in the world today comes from the vertical shaft furnace processes developed by Midrex of USA and HYL of Mexico, both using pellets and/or lumps as feed stock [1]-[6].

Frequently during the direct reduction inside shaft furnaces, a sticking or clustering phenomenon of pellets was observed. The ferrous burden was found to start sticking together in the middle and lower part of the shaft, before the material entered the cooling zone. In the middle shaft, the pellet aggregates formed could be separated by hand, but if it is lower in the furnace, then the sticking was more pronounced. If clustering of the particles in a pellet bed is pronounced, the smooth descending movement of the ferrous burden can be disturbed. In the worst case, the burden descent can be held up, resulting in hanging, followed by a slip when the burden suddenly again moves downwards. Another consequence of clustering in the

pellet layers is the forming of gas channels. Gas channels represent shortcuts for the reducing gas through the ferrous burden, resulting in bad utilization of the gas, and thereby, the fuel rate increases. By using coated pellets, i.e. covering the pellet surface with a thin layer of non-sticking material, it should be possible to decrease the clustering tendency [7]-[9]. Many investigators handled the cluster formation phenomena in shaft furnace [10]-[15]. Results from these investigations indicate that sticking is a result of the growth of fibrous iron precipitates (iron whiskers) that become hooked to each other and finally become crystallized during the initial stages of metallization. One way of preventing the sintering between pellets is therefore to keep the iron surfaces of individual pellets apart. In order to prevent sticking of pellets a coating material, basically inactive under the reducing conditions inside, the shaft furnace can be applied to cover the outer surface of the iron ore pellets.

Coating techniques to avoid cluster formation are thoroughly handled in various studies [16]-[18]. It was found that increase in the gangue content of pellets improves their non-sticking behavior. Pellets coated with calcium carbonate slurry showed very promising results.

In the present work, steel dust (that generated from steel plant) is used as coating material for iron ore pellets, and this study aims to explore steel dust coating effectiveness and determines the best coating conditions.

II. EXPERIMENTAL WORK

A. Raw Material

In this study iron, ore pellets were used in the experiments. These ores are practically used in iron making process. Also, steel dust is used that generated from Electric Arc Furnace. The iron ore and steel dust were characterized with X-ray diffraction (XRD), X-ray fluorescence (XRF), and scanning electron microscope (SEM).

B. Experimental System

Iron ore pellets were coated comparatively with various concentrations of steel dust suspension.

1. Coating Process

Coating material (steel dust) is well mixed with water, and slurry is prepared in various concentrations. Iron ore pellets were showered by the coating slurry in a disc pelletizer.

Various solid concentrations 10, 20, and 30% were used to have a coated steel dust amount of 3.0, 4.0, and 5.0 kg per ton iron ore. Coated pellets were left to air-dry, which was followed by reducibility test.

M. Bahgat is Staff Scientist, H. A. Hanafy is Sr. Engineer TP, and H. Al-Tassan is Director, Technology Management, HADEED - Saudi Iron and Steel Company Jubail Industrial City 31961, Saudi Arabia (e-mail: saddikmb@sabic.com, hanafiha@sabic.com, Tassanh@sabic.com).

2. Reduction Process (Reducibility Test)

The apparatus consists of a reduction furnace supported with a system to supply and regulate the gases, a reduction tube of heat resistance steel, a weighing device to determine the oxygen loss at regular intervals and an electrically heated furnace to heat the test portion to the specified temperature.

The sample weight used for each reduction test is about 500 g in the size range 10.0-12.5 mm. The flow rate of reducing gas during the test period is maintained at about 50 l/min while the temperature is maintained at 985 °C. The schematic diagram and visual photo of the experimental apparatus used in this study were presented in Fig. 1.

The sample is introduced into the chamber. In order to achieve a more uniform gas flow, a two-layer bed of porcelain pellets having a size range of 10.0-12.5 mm is placed between the perforated plate and the test portion. The control panel is used to create the desired program. The reduction tube is closed, inserted into the furnace and suspended centrally from the weighing device. The test samples are dried inside the furnace, then nitrogen gas is allowed to pass through the reduction tube at a flow rate of approximately 25 l/min, and the heating is commenced. After the mass of the test portion becomes constant, H₂ and CO gas mixture is introduced at a rate of 31.5 and 18.5 l/min, respectively. The mass of the test portion is recorded continuously.

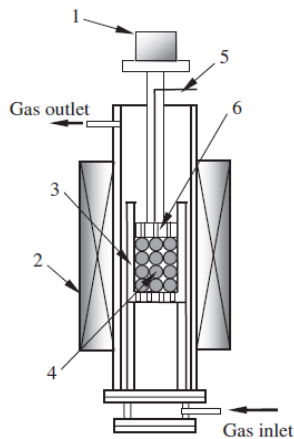

Fig. 1 Schematic diagram of the reduction apparatus 1-Weighting system, 2- Tube furnace, 3- Sample holder, 4- Sample bed in ceramic balls, 5- Thermocouple and 6- Upper arid lower lift

3. Sticking Index (Reduction under Load Test - ISO 11256)

The tendency for cluster formation is measured by detecting the sticking index using reduction under load test. The system is capable of applying a total static load of 147 kPa on a bed of the test portion. The test portion is 2000 g of pellets sample with pellet size – 16.0 mm + 12.5 mm (50 %), and – 12.5 mm + 10.0 mm (50 %). The pellets sample is isothermally reduced in a fixed bed, at 850 °C, under static load, using a reducing gas consisting of 30%CO, 15%CO₂, 45%H₂ and 10%N₂, in a flow rate of 40l/min until a degree of reduction of 95%.

Schematic diagram and visual photo of the Reduction under load - ISO 11256 apparatus are shown in Fig. 2.

Tumble drum apparatus is used to disaggregate the formed cluster by tumbling. The percentage of clusters is determined on the cooled sample. Schematic diagram and visual photo of the tumble drum apparatus are shown in Fig. 3. Tumble drum is made of steel plate at least 5 mm in thickness, having an internal diameter of 1 000 mm and an internal length of 500 mm. Two equally spaced L-shaped steel lifters, 50 mm flat × 50 mm high × 5 mm thick and 500 mm long, to prevent accumulation of material between the lifter and drum. The door shall be so constructed as to fit into the drum to form a smooth inner surface. During the test, the door shall be rigidly fastened and sealed to prevent loss of the sample. The drum shall be rotated on stub axles attached to its ends by flanges welded so as to provide smooth inner surfaces. The drum shall be replaced, in any case, when the thickness of the plate is reduced to 3 mm in any area. The lifters shall be replaced when the height of the shelf is reduced to less than 47 mm.

Carefully we remove all the material from the reduction tube. We determine the mass of the reduced material (m_r). During this operation, some individual pellets usually separate from the clustered material. We remove the pellets and record the mass of the clustered material ($m_{c,i}$). The total rotations are 35 revolutions, divided into seven disaggregation operations of five revolutions each. The weight of the remaining clusters is measured and recorded after each disaggregation operation.

The clustering index, CI, expressed as a percentage, is calculated from the following equation:

$$CI = \frac{100}{8 \times m_r} \times \sum_{i=1}^8 m_{c,i}$$

where m_r is the total mass, in grams, of the test portion after reduction; $m_{c,i}$ is the mass, in grams, of the clusters after the i^{th} disaggregation operations.

III. RESULTS AND DISCUSSION

A. Material Characterization

The various characterization test for iron ore pellets showed that iron oxide (Fe₂O₃) is the major phase with presence of SiO₂, CaO and Al₂O₃ as minor- components (Fig. 4). The SEM photos for iron ore samples are shown in Fig. 5. It was observed that grain coalescence with very low micropores, and many macropores took place in a dense structure.

Almost about 10 different steel dust samples were analyzed, and the average characterization of steel dust, is given in Table I. The dust is mainly 20-30% CaO and CaCO₃ with about 50-60 % Fe₂O₃.

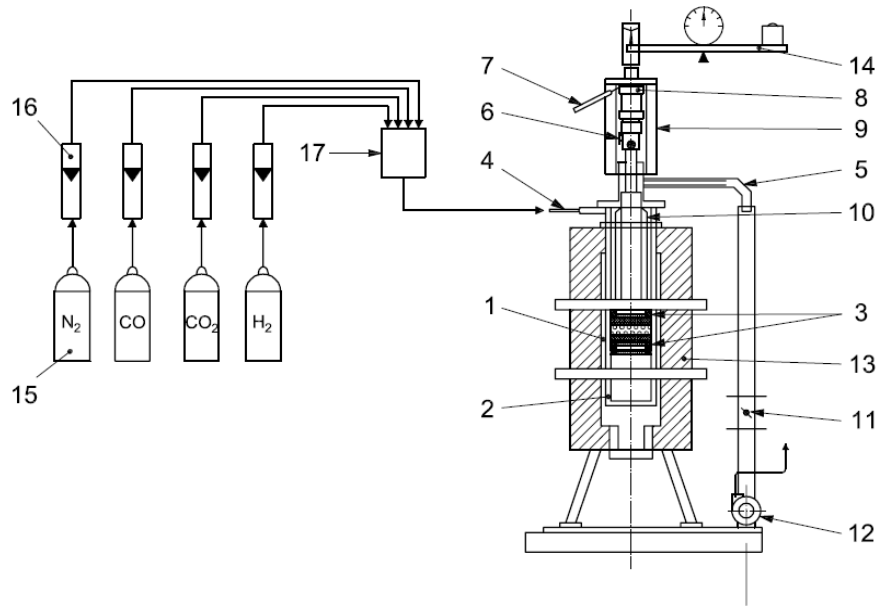

Key

Reduction tube

- 1 outer reduction tube
- 2 inner reduction tube
- 3 upper and lower perforated plates comprising test portion
- 4 gas inlet
- 5 gas outlet
- 6 thermocouple exit

Loading device

- 7 compressed air inlet
- 8 pressure cylinder
- 9 frame for pressure cylinder
- 10 loading ram

Waste gas

- 11 throttle valve
- 12 waste-gas fan

Furnace

- 13 electrically heated furnace
- 14 balance

Gas-supply system

- 15 gas cylinders
- 16 gas flowmeters
- 17 mixing vessel

Fig. 2 Schematic diagram of the reduction under load - ISO 11256 apparatus

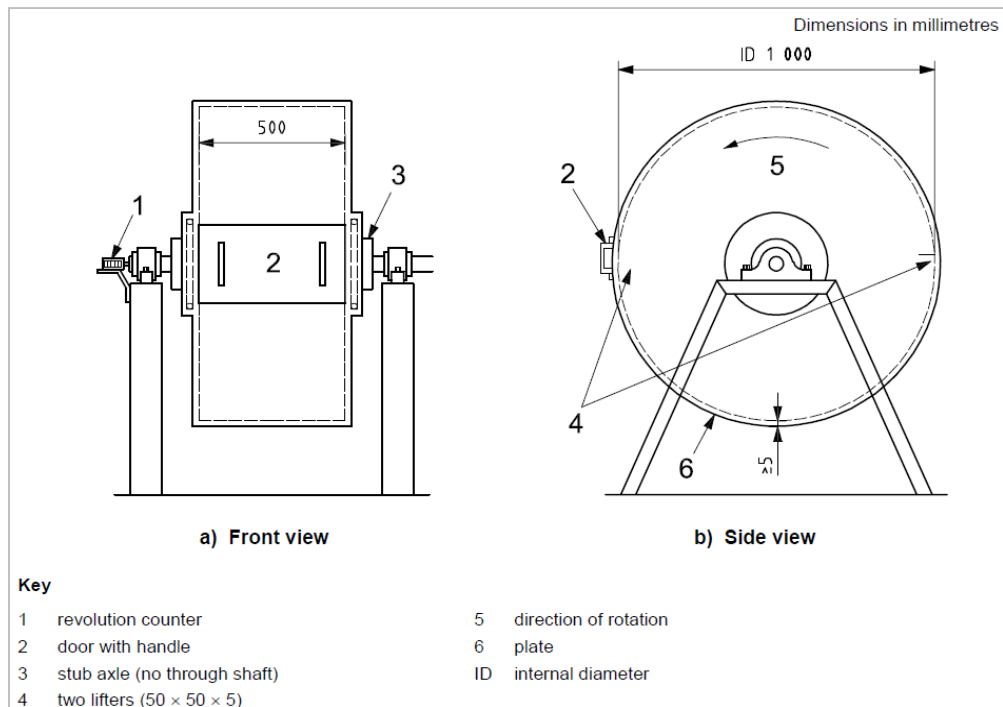

Key

- 1 revolution counter
- 2 door with handle
- 3 stub axle (no through shaft)
- 4 two lifters (50 × 50 × 5)
- 5 direction of rotation
- 6 plate
- ID internal diameter

Fig. 3 Schematic diagram of the tumble drum apparatus

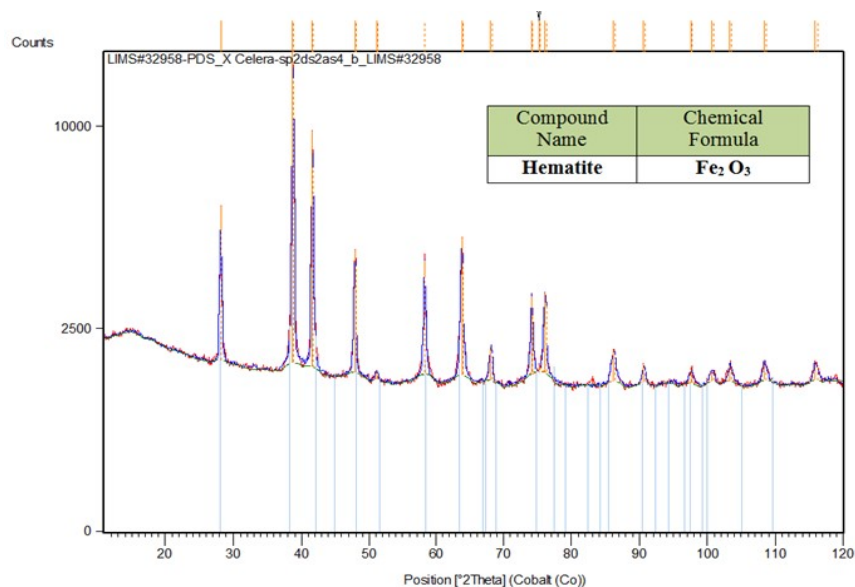

Fig. 4 XRD analysis for iron ore pellets

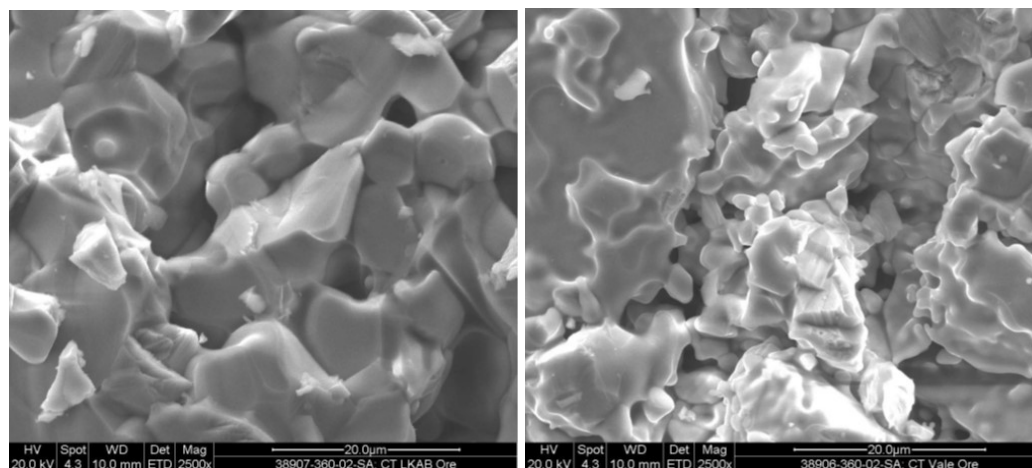

Fig. 5 SEM micrographs of iron ore pellets

TABLE I
CHEMICAL ANALYSIS FOR STEEL DUST

Compound	Conc.%	Element	Conc.%
C	4.719	C	4.719
O		O	30.150
Na ₂ O	0.190	Na	0.140
MgO	8.050	Mg	4.854
Al ₂ O ₃	1.930	Al	1.020
SiO ₂	3.380	Si	1.580
P ₂ O ₅	0.068	P	0.030
S	0.0609	S	0.061
Cl	0.050	Cl	0.050
K ₂ O	0.097	K	0.080
CaO	18.750	Ca	13.400
TiO ₂	0.149	Ti	0.089
V ₂ O ₅	0.065	V	0.036
Cr ₂ O ₃	0.008	Cr	0.005
MnO	0.541	Mn	0.419
NiO	Tracing	Ni	Tracing
ZnO	0.239	Zn	0.192
SrO	0.009	Sr	0.007
PbO	0.012	Pb	0.01
Fe₂O₃	61.683	Fe	43.154

For dust coated pellets, Fig. 6 shows iron ore pellets before and after coating. The surface and internal layers of the coated pellets were analyzed by EDX as shown in Fig. 7. It was found that calcium and carbon have higher percentage on the surface layer compared to the internal one to confirm the formation of dust coating layer.



Fig. 6 Visual photos of iron ore pellets before and after steel dust coating

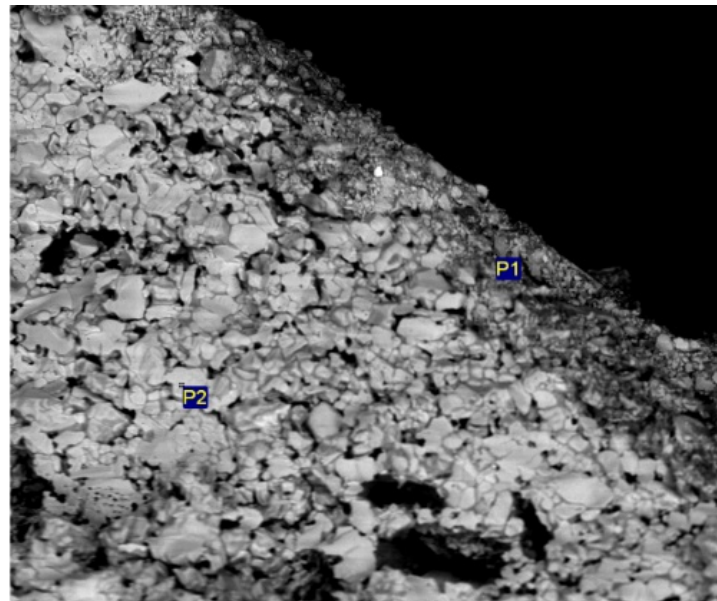

Spectrum	C	O	Mg	Al	Si	Ca	Fe	Total
P1	11.02	51.29	1.19	0.30	0.68	18.92	16.61	100.00
P2	1.70	35.13		0.19			62.98	100.00

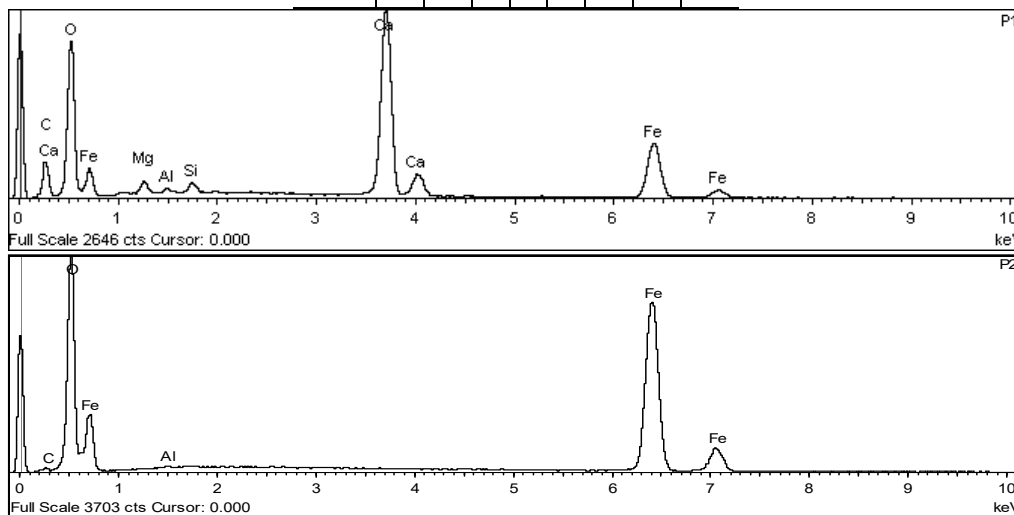

Fig. 7 SEM photo and EDX analysis for lime coating layer of iron ore pellets

B. Reduction Behaviour of Steel Dust Coated Pellets

Using thermo-gravimetric technique, iron ore pellets coated with different steel dust slurry concentrations were reduced at 985 °C with H₂/CO gas mixture. The reduced iron ore samples were characterized with X-ray diffraction analysis (XRD), X-ray fluorescence (XRF), and scanning electron microscope (SEM). It can be seen that metallic iron (Fe) is the major phase with presence of SiO₂, CaO, and Al₂O₃ as minor components. The visual observation of coated iron ore pellets after reduction showed that there is no swelling or cluster formation taking place on the reduced pellets. The influence of both solid dust concentrations per ton iron ore pellets and dust slurry concentrations on the reduction behavior and structural characteristics of the reduced products was studied in order to elucidate the optimum coating conditions.

1. Influence of Solid Concentration

The effect of solid concentration per ton iron ore pellets (3.0, 4.0, and 5.0 kg steel dust per ton iron ore) at constant steel dust slurry concentration was studied. The reduction curve of iron ore pellets coated with 3.0, 4.0, and 5.0 kg dust per ton iron ore using 10% slurry concentration is shown in Fig. 8. It can be seen that the reduction was very fast at early stages and gradually decreased till the end of reduction. The reduction rate value came very similar for the different samples. However, the sample coated with 3.0 kg steel dust has a little bit higher reduction rate. The SEM micrographs for these reduced pellets are shown in Figs. 9 (a)-(c). At the various coating conditions, the metallic iron is homogeneously formed in a very porous structure with presence of large number of micro- and macro-pores forming channels in

structure, which allowed for a good access of reducing gas to the oxides grains. Also some little whiskers were observed through the porous structure.

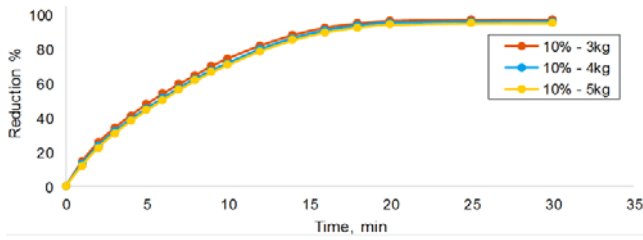

Fig. 8 Reduction curves of reduced iron ore pellets coated with: 10% Steel dust slurry conc. & 3.0 kg per ton iron ore pellets; 10% Steel dust slurry conc. & 4.0 kg per ton iron ore pellets; 10% Steel dust slurry conc. & 5.0 kg per ton iron ore pellets

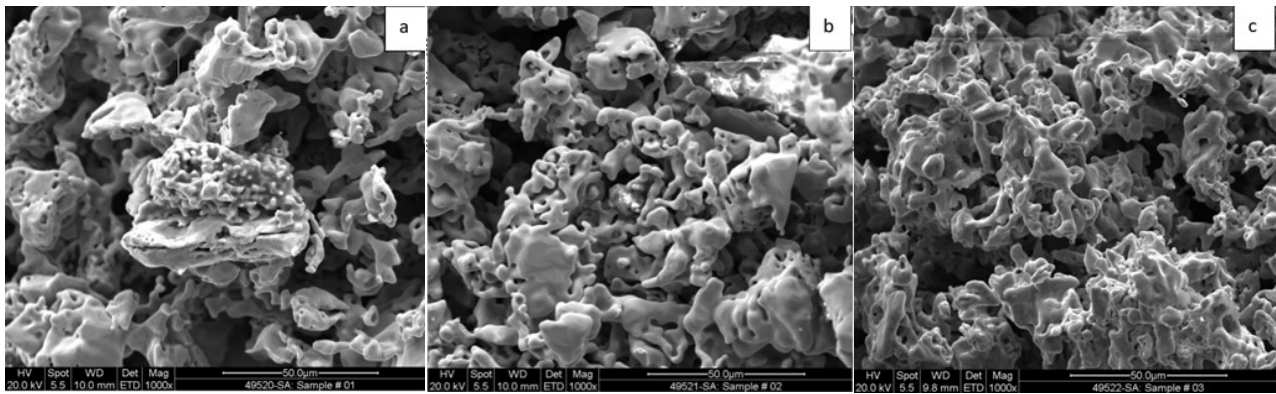

Fig. 9 SEM micrographs of reduced iron ore pellets coated with: 10% steel dust slurry conc. & 3.0 kg per ton iron ore pellets; 10% steel dust slurry conc. & 4.0 kg per ton iron ore pellets; 10% steel dust slurry conc. & 5.0 kg per ton iron ore pellets

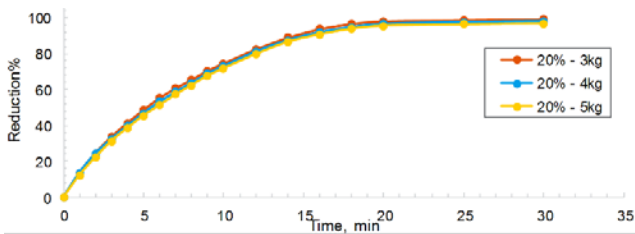

Fig. 10 Reduction curves of reduced iron ore pellets coated with: 20% steel dust slurry conc. & 3.0 kg per ton iron ore pellets; 20% steel dust slurry conc. & 4.0 kg per ton iron ore pellets; 20% steel dust slurry conc. & 5.0 kg per ton iron ore pellets

The reduction curve of iron ore pellets coated with 3.0, 4.0, and 5.0 kg dust per ton iron ore using 30% slurry concentration is shown in Fig. 12. For each single reduction curve, the rate of reduction was highest at the early stages and decreased as reduction proceeds till the end of reduction. The reduction rate value came very similar for the different samples. However, the sample coated with 3.0 kg dust has a little bit higher reduction rate. The SEM micrographs for these reduced pellets are shown in Figs. 13 (a)-(c). At the various coating conditions, the metallic iron is homogeneously formed in a very porous structure with presence of large number of micro- and macro-pores forming channels in structure, which

The reduction curve of iron ore pellets coated with 3.0, 4.0, and 5.0 kg dust per ton iron ore using 20% slurry concentration is shown in Fig. 10. It can be seen that the reduction was very fast at early stages and gradually decreased till the end of reduction. The reduction rate value came very similar for the different samples. However, the sample coated with 3.0 kg steel dust has a little bit higher reduction rate. The SEM micrographs for these reduced pellets are shown in Figs. 11 (a)-(c). At the various coating conditions, the metallic iron is homogeneously formed in a very porous structure with presence of large number of micro- and macro-pores forming channels in structure, which allowed for a good access of reducing gas to the oxides grains. Also some little whiskers were observed through the porous structure.

allowed for a good access of reducing gas to the oxides grains. Also, some little whiskers were observed through the porous structure.

2. Influence of Slurry Concentration

The influence of steel dust slurry concentrations (10%, 20%, and 30%) at constant dust concentration per ton iron ore pellets was studied.

The reduction curve of iron ore pellets coated with 3.0 kg steel dust per ton iron ore using 10%, 20%, and 30% dust slurry concentration is shown in Fig. 14. Also, as mentioned above, for each single reduction curve, the rate of reduction was highest at the early stages and decreased as reduction proceeds till the end of reduction. From the initial up to the final reduction stages, the influence of slurry concentration is observed clearly. It was found that the reduction rate decreased with decreasing the slurry concentration from 30% to 10% gradually. This might be caused by the comparative amount of solution that was used to get the same solid concentration (3.0 kg dust/ton iron ore). More solution was used from 10% slurry compared to other slurries (20% and 30%) that could relatively isolate the pellet's surface from the reducing gas.

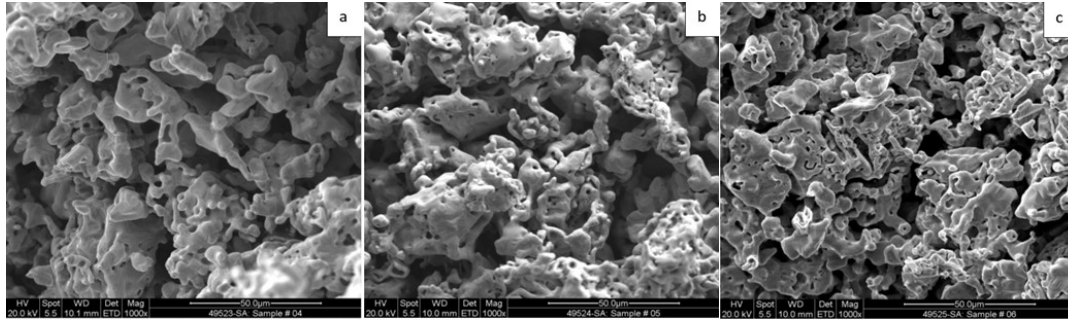

Fig. 11 SEM micrographs of reduced iron ore pellets coated with: (a) 20% steel dust slurry conc. & 3.0 kg per ton iron ore pellets; (b) 20% steel dust slurry conc. & 4.0 kg per ton iron ore pellets; (c) 20% steel dust slurry conc. & 5.0 kg per ton iron ore pellets

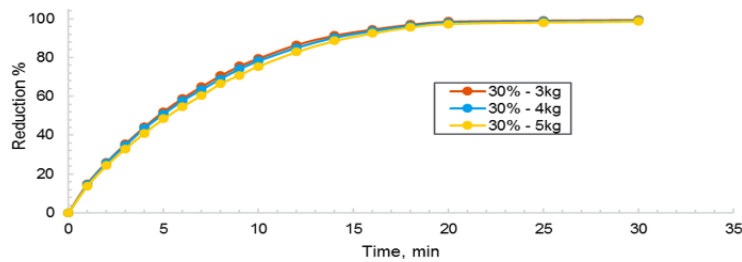

Fig. 12 Reduction curves of reduced iron ore pellets coated with: (a) 30% steel dust slurry conc. & 3.0 kg per ton iron ore pellets; (b) 30% steel dust slurry conc. & 4.0 kg per ton iron ore pellets; (c) 30% steel dust slurry conc. & 5.0 kg per ton iron ore pellets

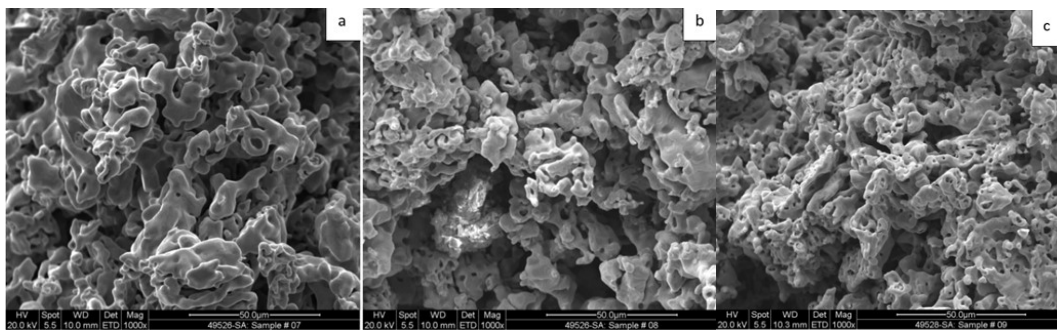

Fig. 13 SEM micrographs of reduced iron ore pellets coated with: (a) 30% steel dust slurry conc. & 3.0 kg per ton iron ore pellets; (b) 30% steel dust slurry conc. & 4.0 kg per ton iron ore pellets; (c) 30% steel dust slurry conc. & 5.0 kg per ton iron ore pellets

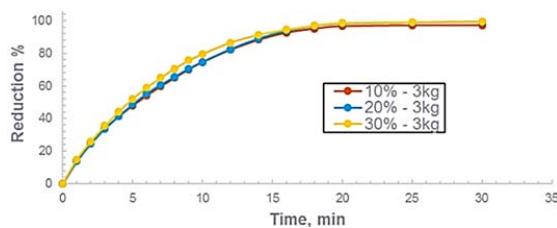

Fig. 14 Reduction curves of reduced iron ore pellets coated with: 10% Steel dust slurry conc. & 3.0 kg per ton iron ore pellets; 20% Steel dust slurry conc. & 3.0 kg per ton iron ore pellets; 30% Steel dust slurry conc. & 3.0 kg per ton iron ore pellets

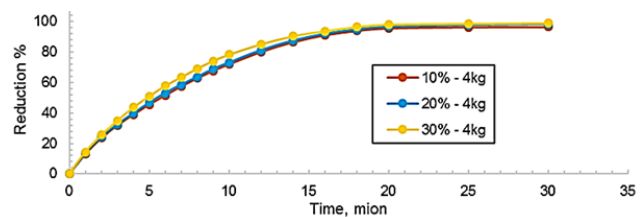

Fig. 15 Reduction curves of reduced iron ore pellets coated with: 10% lime dust slurry conc. & 4.0 kg per ton iron ore pellets; 20% lime dust slurry conc. & 4.0 kg per ton iron ore pellets; 30% lime dust slurry conc. & 4.0 kg per ton iron ore pellets

The reduction curve of iron ore pellets coated with 4.0 kg dust per ton iron ore using 10%, 20%, and 30% steel dust slurry concentration is shown in Fig. 15. The same reduction behavior under the effect of slurry concentration was observed.

C. Sticking Behavior of Coated Pellets

The reducibility of iron ore pellets under the effect of various steel dust coating conditions are comparatively observed as shown in Table II. It was found that the optimum reducibility was obtained during the following steel dust coating conditions;

- 20% steel dust slurry & 3.0 kg dust /ton iron ore pellets

- 30% steel dust slurry & 3.0 kg dust /ton iron ore pellets
- 30% steel dust slurry & 4.0 kg dust /ton iron ore pellets

TABLE II
COMPARATIVE REDUCIBILITY OF IRON ORE PELLETS COATED WITH VARIOUS
STEEL DUST SLURRY CONCENTRATIONS (O) HIGHEST REDUCIBILITY (X)
LOWER REDUCIBILITY

Steel dust slurry concentration	kg steel dust / ton iron ore		
	3.0	4.0	5.0
10%	XO	XX	XX
20%	XO	XX	XX
30%	OO	XO	XO

Sticking index measurement (ISO11256) was applied comparatively on samples coated with these optimized coating conditions. The MIDREX requirement in the clustering test is that % plus 25 mm after 10 revolutions should be zero. As shown in Table III, all the three samples achieved this requirement.

So further comparison was applied on these three coating conditions from the consumption point of view for water and coating material. It was found that using the 30% steel dust slurry concentration with 3.0 kg dust per ton iron ore pellets will be more efficient.

TABLE III
CLUSTERING INDEX MEASUREMENT FOR IRON ORE PELLETS COATED WITH
(A) 20% STEEL DUST SLURRY & 3.0 KG LIME DUST /TON IRON ORE PELLETS,
(B) 30% STEEL DUST SLURRY & 3.0 KG LIME DUST /TON IRON ORE PELLETS,
(C) 30% STEEL DUST SLURRY & 4.0 KG LIME DUST /TON IRON ORE PELLETS

a	Cluster Mass (g)	b	Cluster Mass(g)	c	Mass (g)
1	229 (after Red.)	1	212 (after Red.)	1	179 (after Red.)
2	0 (after 5 rev.)	2	0 (after 5 rev.)	2	0 (after 5 rev.)
3	0	3	0	3	0
4	0	4	0	4	0
5	0	5	0	5	0
6	0	6	0	6	0
7	0	7	0	7	0
8	0	8	0	8	0

IV. CONCLUSIONS AND RECOMMENDATIONS

- Steel dust was examined as a coating material for iron ore pellets.
- The best dust coating conditions are 30% dust slurry concentration with 3.0 kg steel dust/ton iron ore pellets.
- The recommended steel dust coating can be used as secondary coating at DRP.

REFERENCES

- [1] Wright JK, Taylor IF, Philip DK. Minerals Eng 1991; 4: 983–1001.
- [2] Zervas T, Mcullan JT, Williams BC. Int J Energy Res 1996; 20:69–91.
- [3] Feinman J. Iron Steel Eng 1999; 76: 75–77.
- [4] Ali Basdag¹ and Ali Ihsan Arol, Scandinavian Journal of Metallurgy, vol. 31, (2002) 229–233
- [5] <http://www.midrex.com/>: Accessed on: 30/05/2017.
- [6] <http://www.hylsamex.com/>: Accessed on: 30/05/2017.
- [7] Direct reduced iron: Technology and Economics of Production and Use, ed. by J. Feinman and D. R. Mac Rae, ISS, Warrendale, PA, (1999).
- [8] Wong PLM, Kim MJ, Kim HS, Choi CH. Ironmaking Steelmaking, 1999; 26: 53–57.
- [9] L. G. Henderickson and J. A. Sandoval: Iron Steel Soc. AIME, 1980, 35–48.

- [10] R. Nicolle and A. Rist: Metall. Trans. B, 10B (1978), 429.
- [11] H. W. Gudenau, H. P. Eisen, and Y. Qi: Stahl Eisen, 1991, 111, (9), 47.
- [12] S. Hayashi and Y. Igushi: ISIJ Int., 1992, 32, (9), 962–971.
- [13] S. Hayashi, S. Sawai, and Y. Igushi: ISIJ Int., 1993, 33, (10), 1078.
- [14] Jian-Hua Shao, Zhan-Cheng Guo and Hui-Qing Tang ISIJ International, Vol. 51 (2011), No. 8, pp. 1290–1295
- [15] Ben Zhang, Zhi Wang, and Zhancheng Guo, Powder Technology, 225, (2012) 1-6
- [16] Jerker Sterneland and Pär G. Jönsson ISIJ International, Vol. 43 (2003), No. 1, pp. 26–35
- [17] Cano JAM, Wendling F. Mining Eng 1993; 45: 633–636.
- [18] Jianhua Shao, Zhancheng Guo_ and Huiqing Tang, Steel research int., 84 (2013) No. 2, 111-118.