

Static and Dynamical Analysis on Clutch Discs on Different Material and Geometries

Jairo Aparecido Martins, Estaner Claro Romão

Abstract—This paper presents the static and cyclic stresses in combination with fatigue analysis resultant of loads applied on the friction discs usually utilized on industrial clutches. The material chosen to simulate the friction discs under load is aluminum. The numerical simulation was done by software COMSOL™ Multiphysics. The results obtained for static loads showed enough stiffness for both geometries and the material utilized. On the other hand, in the fatigue standpoint, failure is clearly verified, what demonstrates the importance of both approaches, mainly dynamical analysis. The results and the conclusion are based on the stresses on disc, counted stress cycles, and fatigue usage factor.

Keywords—Aluminum, industrial clutch, static and dynamic loading, numerical simulation.

I. INTRODUCTION

THE phenomena of fatigue is the most common form of fracture of metallic structures, accounting for up to 80 % of all costs associated with fracture [1]-[3]. But, apart from the metallic structures, also the nonmetallic ones are subjected to the same phenomena, which bring a wide spectrum and complexity on the theme. Fasteners, for example, despite of apparent simplicity, are important metallic components frequently studied on fatigue, mainly due to their critical role in many engineering structures. Failure of this component may bring catastrophic monetary or other material consequences in some cases – applications [3]. Most of the scientific studies describe common cause of fasteners failure as being by inadequate tension (preload) and clamping force upon installation [3]-[6].

On another extreme are the airplanes, driven by reliability-safety, also one of the most machines studied in terms of modern composite materials application under fatigue. For this particular machine, the author [7] suggests a special rule of fatigue damage accumulation to perform engineering estimative of fatigue life.

The rule basically handles quasi-randomly loaded layered composites with geometric concentrators, longitudinally present along the composite wing of a transport airplane.

Most of the aspects associated with modeling mechanical parts are based on the part design – geometries – material - and the application of external mechanical loads [8]-[11]. As a matter of fact, most of the contemporary studies on mechanical parts make use of numerical simulation that predicts application in the field, not evaluating only parts geometries, but also material and loads as much close as the real

application. Such studies evaluate the influence of the design variables and converging on possible opportunities for product enhancements [12]-[17].

This paper aims to present the impact in terms of lifetime when using aluminum on industrial clutch disc rather than casted iron. In addition, two different geometries for the discs are evaluated and undergo static and dynamic loading by numerical simulation using the software COMSOL™. The disc is a replica of the friction discs applied on industrial clutches, but the material changed from the regular casted iron GG250 to aluminum 3003-H18 (Fig. 1). The software COMSOL™ [18] was used as a tool to calculate the stresses levels, cycle counting and the fatigue damage.

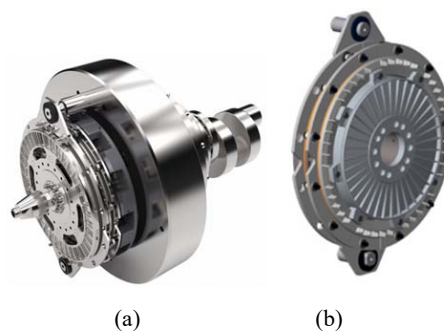

Fig. 1 (a) Industrial clutch plus flywheel, (b) industrial clutch [19]

II. MATERIALS AND METHODS

The software COMSOL™ [18] was used for the 2D modelling as well as for the Finite Element calculations, as shown in Fig. 2. The characteristics of the material used on the clutches calculations are described in Table I. The discs have the same width and thickness as the originals and the loads been applied at the vertical direction and upward, the unique difference is found on the back of the plate, one is flat, and another has two reinforcements - ribs. The rib profile is the same as the original design and follows the usual best practices in terms of mechanical resistance and thermal convection on products like clutches and radiators [19], [20]. As a note, the heat calculation is not part of the scope of this paper.

The usual pressure applied against the disc on industrial pneumatic clutches in the field is 7 bars (0.7 MPa) [19]. The cyclic pressure profile applied on the simulation follows disposal and range from -0.7 MPa to maximum +0.7 MPa as shown in Fig. 3.

Estaner Claro Romão is with the University of São Paulo, Brazil (e-mail: estaner23@usp.br).

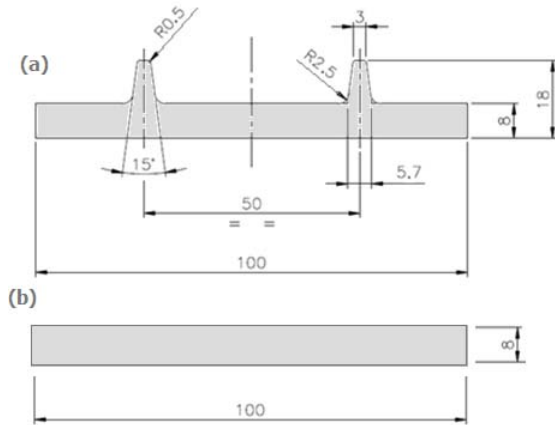

Fig. 2 (a) Disc with ribs / (b) flat plate

TABLE I
 MATERIAL PROPERTIES, ALUMINUM 3003-H18

Characteristic	Symbol	Value	Unit
Ultimate Strength	σ_u	200	MPa
Fatigue Strength	σ_f	69.0	MPa
Young modulus	E	68.9	GPa
Poisson's ratio	ν	0.33	Dimensionless
Density	ρ	2,700	kg/m ³

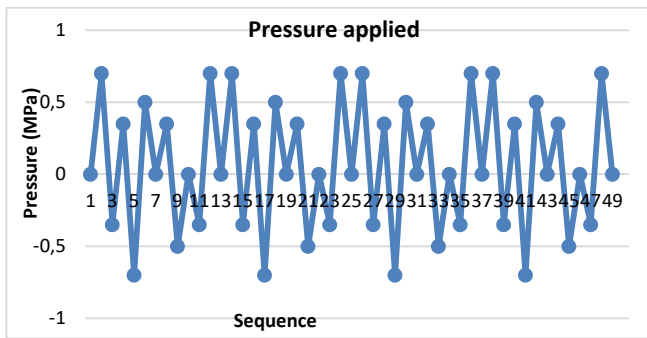

Fig. 3 History of pressure applied

The constraints were settled at both lateral sides, fixed and considered rigid constraint (no degree of freedom), both represent the fixing fasteners of the clutch. The fatigue formulae present in COMSOL™ takes into consideration the Coffin-Manson model, being characterized by,

$$\frac{\Delta \epsilon_i}{2} = \dot{\epsilon}_f (2N_f)^c \quad (1)$$

where $\Delta \epsilon_i$ is the accumulated inelastic deformation, $\dot{\epsilon}_f$ and c are the material constants.

Fatigue life can be determined by combining the Basquin and Coffin-Manson equations as follows:

$$\epsilon_a = \frac{\dot{\sigma}_f}{E} (2N_f)^b + \dot{\epsilon}_f (2N_f)^c \quad (2)$$

For $\dot{\sigma}_f$ as the coefficient of fatigue resistance (MPa), b being the fatigue resistance exponent (dimensionless), $\dot{\epsilon}_f$ the ductility coefficient (dimensionless), c is the coefficient of ductility (dimensionless), and E is the elasticity modulus (MPa). N_f ,

being the number of reverse loads and therefore $2N_f$, is the total number of cycles to fracture for a defined strain amplitude of ϵ_a (mm / mm).

According to [21], the average stress has a significant effect on fatigue life of the components. Morrow proposed a correction in Basquin's model in relation to Basquin and Coffin-Manson of medium tension [21], namely:

$$\epsilon_a = \frac{\dot{\sigma}_f - \sigma_m}{E} (2N_f)^b + \dot{\epsilon}_f (2N_f)^c \quad (3)$$

for σ_m as the mean stress at which the component is subjected.

The Wöhler diagram (S-N curve) is given by the expression

$$\sigma_a = 94E6 \frac{R}{(-0.36)^{2.35}} \cdot N^{-0.091} \quad (4)$$

where σ_a is the stress amplitude, R is the R-value and N is the number of cycles to failure for a constant stress cycle defined by σ_a and R . The relation is valid when the parameter is seen as infinite life and it should not be taken into account in damage calculations.

The cumulative damage by Palmgren-Miner model is calculated and demonstrated in the analysis that follows. In the same model, the damage is calculated for each stress bin. The number of cycles to failure for a constant cycle is taken from the S-N curve which is evaluated at the center of the bin. The Rainflow counting method was used to count load cycles and transfers it into a stress distribution of the applied load history.

The cumulative damage depends on the combination of stress levels and the number of counted cycles (see (5)) [21]. Each bin contributes to the fatigue usage factor with (5). The analysis is done based on the profile of the load, see Fig. 3. Once the stress distribution is known, the Palmgren-Miner linear damage rule is used to calculate a cumulative damage. This damage in the Fatigue Module is called the fatigue usage factor and evaluated as:

$$f_{us} = m \cdot \sum_{i=1}^q \frac{n_i}{N_i} \quad (5)$$

where n_i is the number of cycles in bin i , N_i is the maximum number of cycles until fatigue occurs for bin i , q is the number of bins, and m is number of repeated cycle blocks in the load history, see Fig. 3. Usually a fatigue usage factor of 1 or larger means that the component fails due to fatigue. If the cycles in the bins describe the entire load history, the stress cycle is not repeated and thus $m = 1$.

III. RESULTS

The stressed obtained with the highest pressure applied on both geometries studied are shown in the Figs. 4 and 5. The counted stress cycles, based on the Rainflow method, are demonstrated at Figs. 6 and 7 and finally the fatigue analysis in terms of fatigue usage factor at Figs. 8 and 9.

The values obtained in Figs. 4 and 5 demonstrate lower stresses on the middle of the plates (32 MPa), for both geometries and the highest values (60 MPa) found on the extremes. The values are lower than the material mechanical

properties described on Table I.

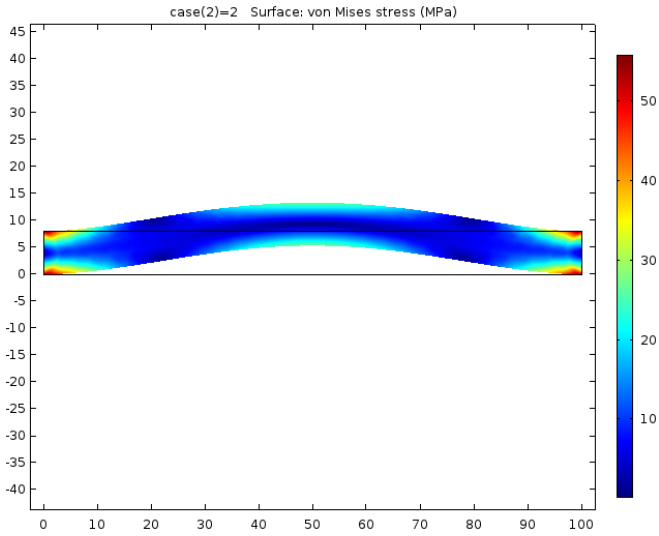

Fig. 4 Stresses on disc geometries (flat)

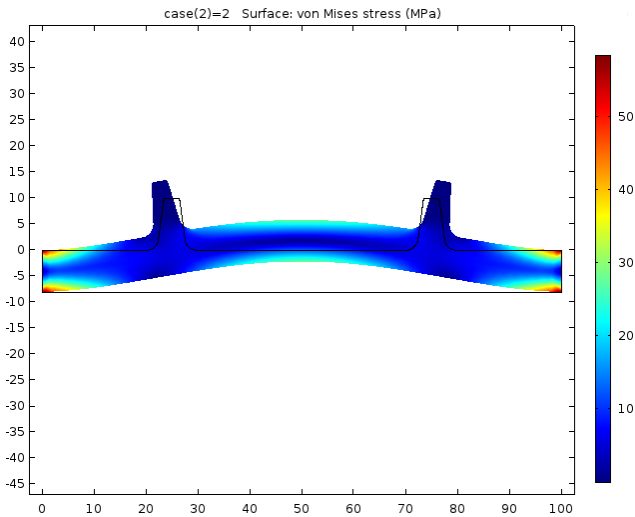

Fig. 5 Stresses on disc geometries (with ribs)

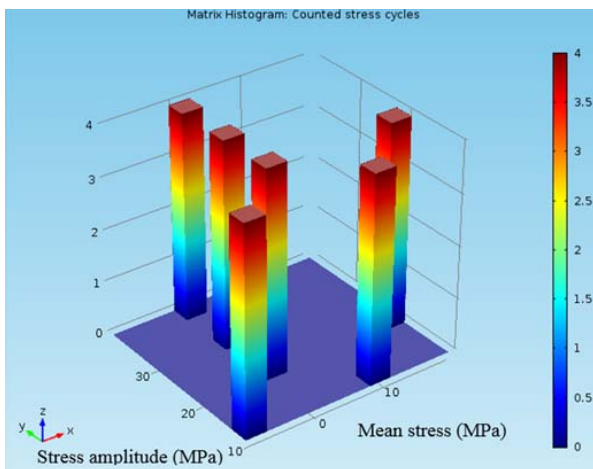

Fig. 6 Counted stress cycles (flat)

In terms of counted stress cycles per bin, the distribution of the bars is the same for both geometries and most of them present value close to four stress cycles, which are based on the counting by using the Rainflow theory.

Regarding the fatigue usage factor, calculated by (5) and shown on Figs. 8 and 9 for both disc geometries, the maximum value is verified at the middle of the plates and on their fixed constraint (close to 8). As described before, the values higher than 1 mean that the component fails by fatigue.

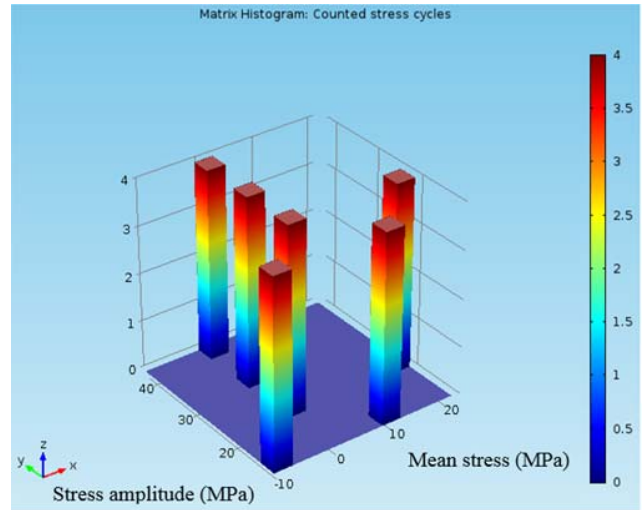

Fig. 7 Counted stress cycles (with ribs)

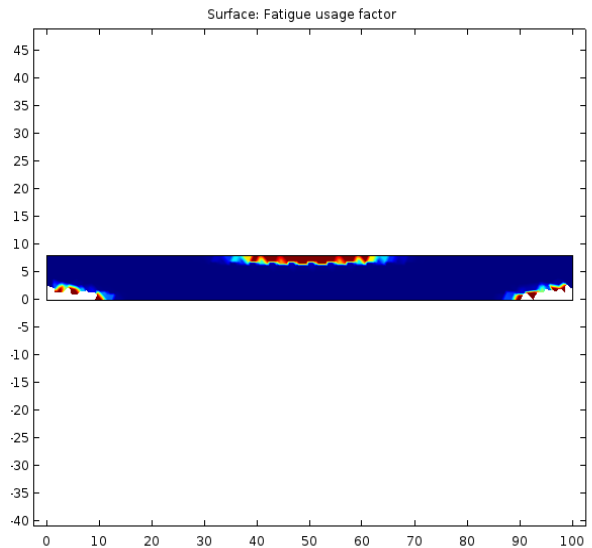

Fig. 8 Fatigue usage factor (flat)

IV. CONCLUSIONS

The impact in terms of stiffness when using aluminum on industrial clutches disc rather than the usual casted iron in conjunction with two different geometries for the discs is minimal under the static standpoint. On the other hand, the results showed a high potential risk of failure already on engineering phase whether cyclical stresses are taken into

account. While static analysis shows that the material can overcome the load, the dynamic analysis reveals the premature failure by fatigue. Definitely, the change of the original material from cast iron to aluminum is not recommendable once the aluminum can withstand the static loading but not the cyclic one, usually found on the application.

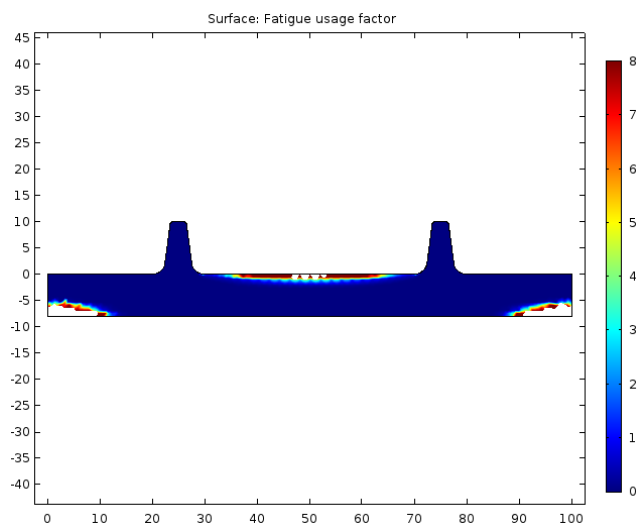

Fig. 9 Fatigue usage factor (with ribs)

The applied geometry with reinforcement on the disc did not decrease the stresses levels as expected. The reinforcement may bring benefits in the thermodynamics standpoint, but in the mechanical perspective it does not.

The final contribution of this paper is to reveal the importance of making Multiphysics Analysis, in this case combining static and cyclical analysis. The regular and simplified static analysis may result in catastrophic failures in the field, as might be in the case of clutches.

ACKNOWLEDGMENTS

The authors thank the FAPESP by process 2014/06679-8 and DESCH Canada Ltd for the fundamental support.

REFERENCES

- [1] A. Handbook, Failure Analysis and Prevention, vol. 11, ASM International, 2002, pp. 708-811.
- [2] M. Handbook, Failure Analysis and Prevention, 9 ed., vol. 11, ASM International, 1986.
- [3] B. Hudgins A. and James, "Fatigue of Threaded Fasteners," Advanced Materials & Processes, p. 5, 2014.
- [4] J. Bickford, Introduction to the Design and Behavior of Bolted Joints, 4 ed., CRC Press, 2008.
- [5] A. A574-00, "Standard Specification for Alloy Steel Socket-Head Cap Screws," in ASTM A574-00, American Society for Testing and Materials.
- [6] A. A. K. S. C. A. Manwatkar, "Failure Analysis of High Tensile Industrial Fasteners," International Journal of Scientific and Research Publications, vol. 6, no. 3, 2016.
- [7] V. Strizhius, "Fatigue damage accumulation under quasi-random loading of composite airframe elements," Mechanics of Composite Materials, vol. 52, pp. 455-468, 2016.
- [8] J. a. D.B.Gowin, "Learning how to learning," Cambridge University Press, 1988.
- [9] O. J., Modelling with the computer at all ages, London: University of

- London, 1997.
- [10] S. R. a. S. R. Pedgen C.D., Introduction to simulation using SIMAN, McGraw-Hill, 1990.
- [11] Y. Xu, "Micromechanical modelling of composite compressive strength," Journal of Composite Materials, pp. 572-588, 1993.
- [12] L. J. R. E. Martins J.A., "Studying 3D clutch segment by Multiphysics in heat transfer solid mechanics, pondering variable statistically (DOE)," International Journal of Engineering Trends and Technology - IJETT, vol. 38, 2016.
- [13] H. A. a. O. Gundogdu, "Pn the buckling analysis of plates reinforced with stiff ribs," Mathematical & Computational Applications, vol. 8, no. Document, pp. 103-110, 2003.
- [14] Y. V. K. a. M. Mukhopadhyay, "A new finite element for buckling analysis of laminated stiffened plates," Composite Structures, no. Document, pp. 321-331, 1999.
- [15] O. K. a. O. Gundogdu, "On the curvature of an Euler-Bernoulli beam," International Journal of Mechanical Engineering Education, vol. 31, no. Document, pp. 132-142, 2003.
- [16] R. P. Paul, "Robot manipulators: Mathematics, Programming and Control, (Artificial Intelligence)," The MIT Press , no. Document, 1981.
- [17] E. a. F. Payer, "Die Akustikanalyse von Verbrennungsmotoren," MTZ 56, 1995.
- [18] COMSOL, "COMSOL 5.0 Multiphysics," 2014.
- [19] DESCH, "Desch Antriebstechnik GmbH," 2015.
- [20] Z.Chen, "Finite Element Analysis of Thermomechanical Process in Disk Clutch Systems," University of Denver, 2013.
- [21] C. 5.0, "Fatigue Module Users Guide," 1998-2014.