

Soil Moisture Control System: A Product Development Approach

Swapneel U. Naphade, Dushyant A. Patil, Satyabodh M. Kulkarni

Abstract—In this work, we propose the concept and geometrical design of a soil moisture control system (SMCS) module by following the product development approach to develop an inexpensive, easy to use and quick to install product targeted towards agriculture practitioners. The module delivers water to the agricultural land efficiently by sensing the soil moisture and activating the delivery valve. We start with identifying the general needs of the potential customer. Then, based on customer needs we establish product specifications and identify important measuring quantities to evaluate our product. Keeping in mind the specifications, we develop various conceptual solutions of the product and select the best solution through concept screening and selection matrices. Then, we develop the product architecture by integrating the systems into the final product. In the end, the geometric design is done using human factors engineering concepts like heuristic analysis, task analysis, and human error reduction analysis. The result of human factors analysis reveals the remedies which should be applied while designing the geometry and software components of the product. We find that to design the best grip in terms of comfort and applied force, for a power-type grip, a grip-diameter of 35 mm is the most ideal.

Keywords—Agriculture, human factors, product design, soil moisture control.

I. INTRODUCTION

AGRICULTURE is a fundamental activity that humans have carried out since prehistoric times. The agriculture industry has flourished since then and has been an important part of human civilizations. Apart from electricity, fertilizer, pesticides and sunlight, the main resource utilized in agriculture is water. A large amount of water is being used for irrigation in agriculture-based countries like India. Because of non-cautious use, thousands of gallons of water are wasted every day. A variety of systems are available which use sensor networks for assessing water usage. Many researchers have worked on wireless sensor networks and efficient data transfer algorithms [1]-[4]. Various methods for soil moisture sensing are also available [5], [6]. For self-sustainable systems, solar powered controllers are proposed [3], [7]. Though the current generation of farmers is educated about the importance of judicious use of water, not many of them employ these modern systems to do so. The prime reasons behind it are the high cost of inventory and high skill requirements to operate. Sensor networks often turn to be cumbersome to install. In this paper, we employ product development approach to design a low cost and easy to install SMCS.

S.U. Naphade, D.A. Patil and S.M. Kulkarni are with the National Institute of Technology Karnataka, Surathkal, Mangalore, KA, India—575025 (e-mail: naphadeswapneel@gmail.com).

The system consists of a microcontroller, soil moisture sensor and a solenoid valve, which will be connected to higher head pipes. The module will sense soil moisture and activate solenoid valve to deliver an optimum quantity of water to maintain the soil moisture. The proposed system can be used as a standalone product or as a network of systems. Human Factors engineering principles are employed in the geometrical design of the system. This unique feature makes it user-friendly.

II. PRODUCT DEVELOPMENT PROCESS

A generic product development process as discussed in [8] is used to develop the SMCS. The various steps in the product development process can be enumerated as:

- 1) Identifying customer needs
- 2) Establishing target specifications
- 3) Concept generation
- 4) Concept selection
- 5) Product architecture
- 6) Setting final specification
- 7) Project planning
- 8) Economic analysis
- 9) Benchmarking competitors
- 10) Modelling and prototyping

We have followed the product development process until product architecture to realise the integrated system design. We then extend the system level design to include human factors to make the product more user-friendly and aesthetically appealing.

A. Customer Needs

The product development process starts with knowing the customer needs. Customer statements are acquired through various activities like personal interviews, suggestion forms, group discussions or internet-based surveys. Then, customer needs are identified from customer statements. The identified needs are then organised and relative importance is assigned to them on a scale of 1 to 5.

B. Product Specifications

The needs established in the previous section are subjective. To make them quantifiable, specifications are assigned to them. Specifications are communicated in terms of metrics. A metric is a measurable quantity associated with an entity, for example, metric for durability is life in years. Need-metric matrix is helpful in assessing the relationship of various needs with the measurable metric quantities. A specification has two parts: unit and value. Specifications tell engineers *what* exactly is expected from the product in terms of quantifiable

entities. Later, marginal values are given to the metrics by benchmarking with competitive products.

C. Concept Generation

The next step in the product development process is identification and distribution of technical problems and generation of solution concepts. Initially, a function diagram is drawn which depicts the functions carried out by the product. The problem, which is needed to be solved by the product, is broken down into subproblems. Now, many solutions to these sub-problems are conceived through brainstorming, internal and external research. These solutions are then written down in a table called Concept Combination Table.

Each solution selected from the categories in Concept Combination Table form a unique combination solution to the problem. Not all the combinations of potential solutions are feasible hence; all feasible solutions are selected from the combinations arising from the Concept Combination Table. The selected solutions are then graded based on various selection criteria in a Concept Screening matrix. One concept is chosen as a reference and all other solutions are given a '+', '-' or '0' rating based on whether its performance is better, worse or equal respectively with respect to the reference. Then, ratings for all the criteria are added up to get final ratings. From this rating, best two or three solutions are selected. The best two solutions are then evaluated extensively by giving a five-scale rating to their performance in particular criteria in a Concept Scoring Matrix. Finally, the best performing solution is selected.

D. Product Architecture

In this phase, various physical entities of the product are assigned functions. In a slot modular architecture, physical chunks of the product are assigned unique functions hence one function is carried out by only one physical entity. This facilitates the replacement of parts and ease of upgradation. Thus, a slot modular architecture is implemented in the design.

E. Human Factors Considerations

Making the product intelligible to the user is one of the main objectives of this exercise. There are several methods [9] with which we can incorporate human factors in product design. We will use the following methods to make the product user-friendly:

i. Heuristic Analysis

The heuristic analysis [9] relies on judgement, intuition and experience of the designer to assess the utility of a product. It is a highly subjective technique and the results may vary from person to person. The main advantages of the heuristic analysis are that it is very quick to execute and requires less expertise on the designer's side. In many ways, the heuristic analysis technique resembles a product walk through where the designer imagines how the product will be used and notes down the sequence of user actions.

ii. Hierarchical Task Analysis (HTA)

Hierarchical task analysis [9] is used to break down the

product usage into various tasks and sub-tasks. Using this technique, a complete description of product usage can be obtained which serves as an input to the human error prediction tasks. Tasks derived from heuristic analysis done before are broken down in a detailed manner.

iii. Systematic Error Reduction and Prediction Approach (SHERPA)

Systematic human error reduction and prediction approach (SHERPA) [9] is a technique to identify potential errors in the utilization of the product. It is based on hierarchical task analysis (HTA) and error enumeration. Briefly, each task step from the bottom-level in HTA is taken in turn and potential errors associated with that activity are identified. From this, the consequences of those errors are determined and remedies to prevent them are incorporated in the design.

F. Geometric Design

i. Grip Design

As the product will be held in the hand while inserting in the ground it is inevitable to design the grip for less effort and more comfort. There are two types of grips: precision grip and power grip. Precision grip is how a person holds a pen while power grip is how a person holds a tennis racquet. The product will be held with a power grip; therefore, we study the effect of various diameters of a power grip on the comfort and gripping force. Fig. 1 [10] shows the effect of handle diameter on gripping comfort.

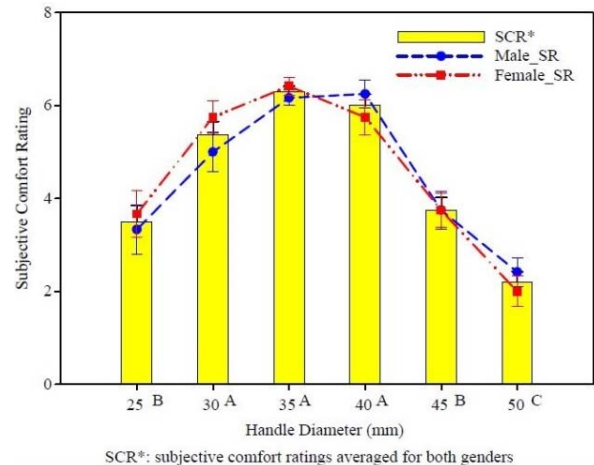

Fig. 1 Grip Comfort for different Grip Diameters [10]

Then we look at the gripping force shown in Fig. 2 [10]. It is apparent that gripping force decreases as the diameter increases. Anthropometric data of hand width are referred to design the length of the grip [11]. According to the anthropometric data shown in Fig. 3, the maximum length of hand is 10.6 cm.

ii. Button Design

According to the guidelines for button design given in [12], the button size for finger actuated button should be between 10 to 25 mm for bare hands and minimum 19 mm for gloved

hands. Also, the top surface should be slightly concave so that the finger does not slip while pressing the button.

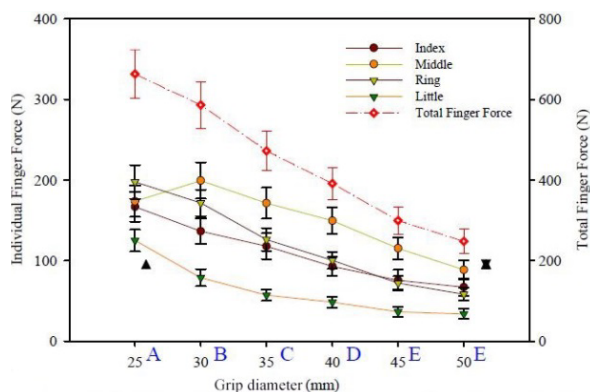

Fig. 2 Gripping force for various grip diameters [10]

Hand Breadth					
FEMALE N = 2208			MALE N = 1774		
Centimeters	Mean	Inches	Centimeters	Mean	Inches
7.94	.38	3.13	9.04	3.56	
	Std Dev	.15	.42	.17	
9.80	Maximum	3.86	10.60	4.17	
6.60	Minimum	2.60	7.70	3.03	

Fig. 3 Anthropometric data of handbreadth [11]

III. RESULTS AND DISCUSSION

Following the product development process, as discussed in Section II, we develop the concept for SMCS module and then design the geometry using human factors engineering.

A. Customer Needs

Table I shows the general customer needs regarding the

SMCS. The customer needs are identified from general customer statements and an importance rating is given as shown in Table III.

TABLE I
IDENTIFIED NEEDS

Customer statements	Interpreted needs
Should be easy to install	SMCS is easy to install
Should be cost effective	SMCS is cost effective
Should sprinkle water in required space only	SMCS delivers water in required area
Shouldn't water the plants if it's raining	SMCS doesn't deliver water during rain
Should have enough length to cover the whole plantation	SMCS has adequate coverage area
The quantity of water sprinkled should be according to plant type.	SMCS delivers water according to plant type
Should be durable	SMCS is durable
Should withstand all weather conditions.	SMCS is durable
Should provide information about the amount of water used to keep track of the water bill.	SMCS provides information about amount of water delivered
The amount of water sprinkled should be adjustable.	SMCS has adjustability for moisture level in the soil
Should be able to run on 12V battery or solar power when there is no electricity.	SMCS is flexible in terms of power supply
Should be operational even when the water level in the overhead tank is low.	SMCS is operational at a low head.

B. Product Specifications

Metrics are assigned to the needs so that we can design the product with quantifiable results by preparing a Need-Metric Matrix as shown in Table IV. Our goal is to design an easy to use, quick to install and energy efficient system hence the metric values are assigned accordingly to SMCS as shown in Table II.

TABLE II
SPECIFICATIONS AND MARGINAL VALUES OF METRICS

Addressed need	Metric	Unit	Marginal Target value
1,2	Installation time	min	60
5	Coverage area	km ²	0.5-1
3	Delivery area	m ²	1-2
4,6,7	Soil moisture range	% kg moisture/kg soil	30-70%
2	Power consumption	kWh	3-5/day
2	Water consumption	Litre	According to plant
8	Durability (Product Life)	years	5
10	Operating voltage	V	12-24V
9	Data transfer speed	kbps	400
8	Operating temperature	°C	0-50
11	Minimum Water head	m	3

C. Concept Generation

The problem of delivering a precise amount of water is divided into four sub-problems viz. Power supply, Sensing, Water delivery actuation and data processing as shown in Fig. 4. As the product is required to be flexible with power supply, voltage step-down circuits and voltage regulators provide a potential solution to power supply problem. For data processing and transmission, microcontroller and Bluetooth module are the best solutions in terms of performance, flexibility and development cost. The feasible concepts

solving sensing, actuation and delivery problems are listed and are arranged in concept combination table for further analysis as shown in Fig. 5.

- Concept 1: Sensor matrix → Solenoid Valve → Sprinkler
- Concept 2: Sensor matrix → Solenoid Valve → Drip system
- Concept 3: Single sensor → Delivery pump → open channel
- Concept 4: Single sensor → Solenoid Valve → Sprinkler
- Concept 5: Single sensor → Solenoid Valve → Drip

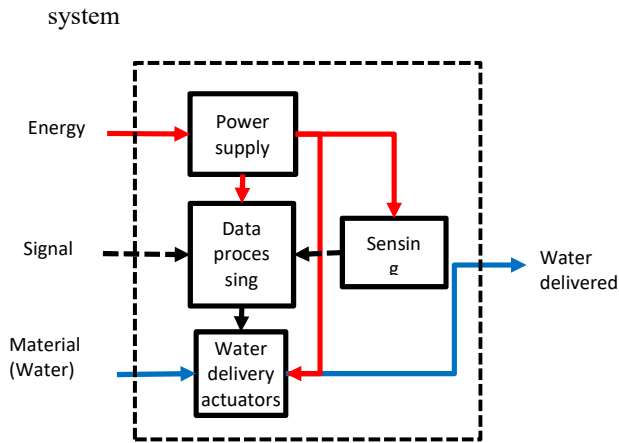

Fig. 4 Function Diagram of SMCS

TABLE III
NEED ORGANIZATION AND SCORING

No.	Need	Importance
1	Easy to install	4
2	Cost-effective	4
3	Confined region of operation	3
4	Water supply depending on soil moisture	5
5	Coverage area	3
6	Adjustability for plant type	1
7	Adjustability of soil moisture	4
8	Durability	4
9	Information provision	1
10	Flexible with power supply	3
11	Required head is low	2

TABLE IV
NEED-METRIC MATRIX

Needs	Metric	Installation time	Power consumption	Water consumption	Delivery area	Soil moisture range	Coverage area	Product Life	Operating temperature	Data transfer speed	Operating voltage	Water head
Easy to install		•										
Cost-effective		•	•	•								
Confined region of operation					•							
Water supply depending on soil moisture						•						
Coverage area							•					
Adjustability for plant type						•						
Adjustability of soil moisture						•						
Durability								•	•			
Information provision										•		
Flexible with power supply											•	
Required water head												•

Sensor configuration	Actuation	Delivery method
Single sensor	Solenoid valve	Sprinkler
Sensor matrix	Delivery pump	Drip system
		Channel

Fig. 5 Concept Combination Table

After comparing the solutions in concept screening matrix shown in Table V, two solutions viz. Concept 2 and Concept 5 are selected. Then, the two solutions are further analysed in concept scoring matrix as shown in Table VI.

From that, we select Concept 5 because of its superior performance in terms of cost and installation time.

D. Product Architecture

The slot modular architecture is implemented in the design. Fig. 6 shows the relationship between functional elements and physical chunks of the product. Later all the systems are integrated to realize an integrated system design as shown in Fig. 7. The module consists of two electrodes for soil moisture

sensing and a dripper attached to the solenoid valve for water delivery.

TABLE V
CONCEPT SCREENING MATRIX

Selection criteria	Concept 1	Concept 2	Concept 3	Concept 4 (Reference)	Concept 5
Cost	-	-	-	0	+
Confined operational area	-	+	-	0	+
Water usage	-	+	-	0	+
Installation time	-	-	-	0	+
Field coverage area	+	+	0	0	-
Power required	+	+	-	0	+
Sum +’s	2	4	0	0	5
Sum 0’s	0	0	1	6	0
Sum -’s	4	2	5	0	1
Net score	-2	2	-4	0	4
Continue?	No	Yes	No	No	Yes

E. Human Factors Considerations

i. Heuristic Analysis

In Fig. 9 the heuristic analysis is shown for the SMCS. The user will open the packaging, turn on the device, install it, pair it with a smartphone via Bluetooth and then change or access data from it.

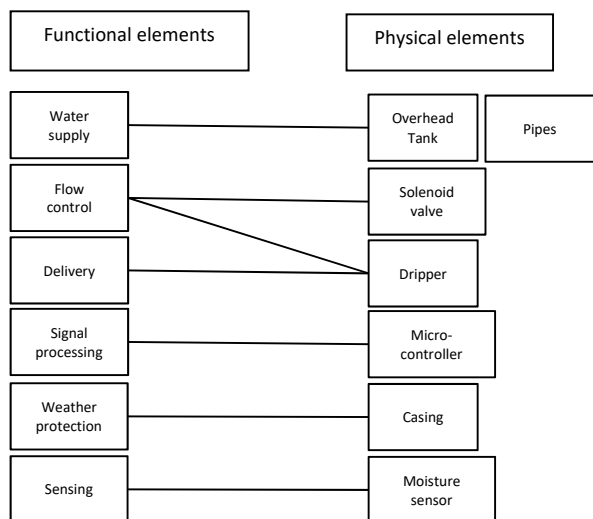

Fig. 6 Slot Modular Architecture of SMCS

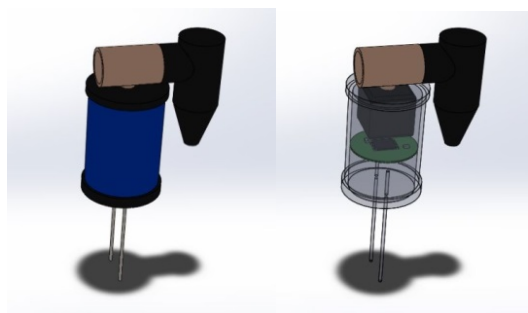

Fig. 7 Integration of systems

i. Hierarchical Task Analysis (HTA)

Tasks derived from heuristic analysis done before are broken down in a detailed manner as shown in Fig. 10.

ii. Systematic Human Error Reduction Prediction Approach (SHERPA)

Table VII shows the use of SHERPA technique to identify potential errors in the product operation using the results from Hierarchical Task Analysis.

F. Geometric Design

From Fig. 1, it is apparent that the most comfortable diameter for grip is between 35 to 40 mm. Also, from Fig. 2, the gripping force increases as we decrease the diameter. Hence, the ideal grip diameter is 35 mm, which is chosen for the grip design.

TABLE VI
 CONCEPT SCORING MATRIX

Selection criteria	Weight	Concept 2		Concept 5	
		Rating	Weighted score	Rating	Weighted score
Cost	30%	2	0.6	4	1.2
Confined operational area	20%	3	0.6	3	0.6
Water usage	10%	3	0.3	3	0.3
Installation time	10%	1	0.1	5	0.5
Field coverage area	10%	3	0.3	3	0.3
Power required	20%	3	0.6	4	0.8
Total score			2.5		3.7
Continue?			No		Yes!



Fig. 8 SMCS Module (front view)

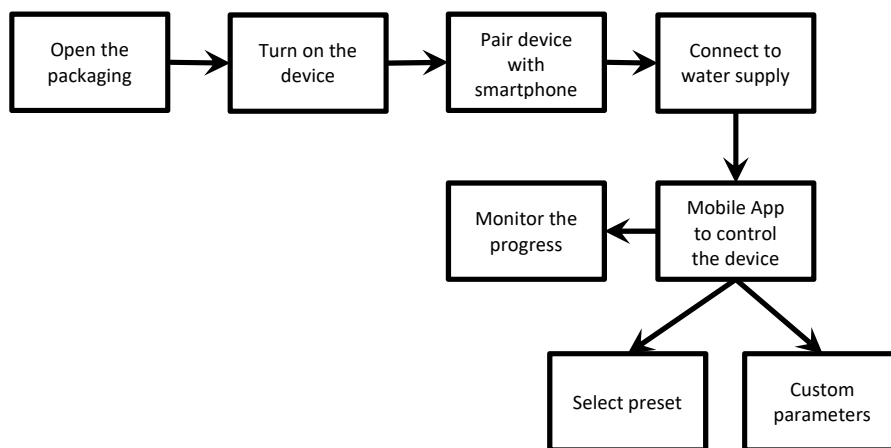

Fig. 9 Heuristic Analysis

TABLE VII
SYSTEMATIC HUMAN ERROR REDUCTION AND PREDICTION APPROACH

Task step	Error Description	Consequence	Remedies
2.1	Forgot to connect water supply	Watering will not happen	Print instruction/symbols on device
2.2	Difficult to insert the device into the ground	Cannot sense the soil humidity	Design a user-friendly handle
3	Forgot to charge the device	Device will not work	Display battery status/give indication to charge the device
3.2	Battery damaged due to overcharging	Device stop working	Automatic charging cut-off after overvoltage
4.1	Cannot press/find the button	Device not connected	Design button with a larger diameter and clear visual symbols.
4.2	Cannot pair device with smartphone	Device not connected. Cannot access data/ set parameters	Bluetooth software redesign
5.1	Inadequate custom parameters	Device won't function as expected	Warning message when setting the custom parameters
5.1.1	Couldn't send the settings	Device won't function as expected	Work on the robustness of the data communication.
5.2.1			
6.2.1	File too large cannot save/send	Cannot study/process the data	Optimize the file size using different data structure.
6.3.1			

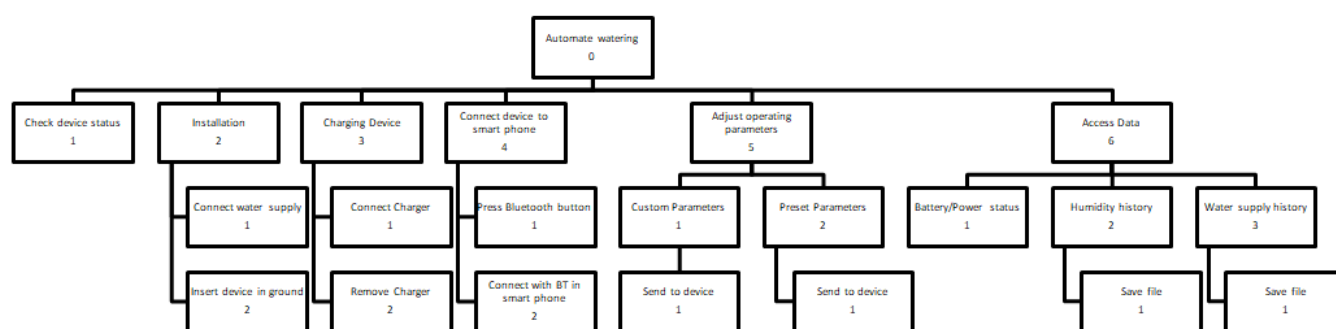

Fig. 10 Hierarchical Task Analysis

For button design, a button diameter of 10 mm is chosen which is within the recommended range. Fig. 8 shows the final rendering of the geometrical design of SMCS.

IV. CONCLUSION

The SMCS is designed and developed following the product development approach and human factor engineering principles. A grip diameter of 35 mm is chosen which corresponds to maximum comfort and a cumulative gripping force of 240 N. The buttons for power and Bluetooth pairing are designed for the diameter of 10 mm for less space occupancy. The moisture sensor, made up of two electrodes, is integrated into a probe attached at the bottom of the module. The module can be used as a standalone device or many modules can be used in a network. These features make the product easy to use, quick to install and flexible. The future work consists of the detailed design of application software and embedded system software for accomplishing the task of efficient water delivery to the fields.

REFERENCES

- [1] Z. Feng, "Research on water-saving irrigation automatic control system based on internet of things," *International Conference on Electric Information and Control Engineering*, 2011, pp. 2541–2544.
- [2] M. Nesa Sudha, M. L. Valarmathi, and A. S. Babu, "Energy efficient data transmission in automatic irrigation system using wireless sensor networks," *Comput. Electron. Agric.*, vol. 78, no. 2, pp. 215–221, 2011.
- [3] M. Dursun and S. Ozden, "A wireless application of drip irrigation automation supported by soil moisture sensors", *Scientific Research and Essays*, vol. 6, no. 7. 2011.

- [4] Y. Kim, R. G. Evans, and W. M. Iversen, "Remote Sensing and Control of an Irrigation System Using a Distributed Wireless Sensor Network," *IEEE Trans. Instrum. Meas.*, vol. 57, no. 7, pp. 1379–1387, 2008.
- [5] Muñoz-Carpena, R., & Dukes, M. D. (2005). Automatic irrigation based on soil moisture for vegetable crops. *Fact Sheet ABE*, 356.
- [6] R. J. Quails, J. M. Scott, and W. B. DeOreo, "Soil Moisture Sensors for Urban Landscape Irrigation: Effectiveness and Reliability," *JAWRA J. Am. Water Resour. Assoc.*, vol. 37, no. 3, pp. 547–559, 2001.
- [7] J. Uddin, S. M. T. Reza, Q. Newaz, J. Uddin, T. Islam, and J. M. Kim, "Automated irrigation system using solar power," *7th International Conference on Electrical and Computer Engineering*, 2012, pp. 228–231.
- [8] Karl Ulrich, Steven Eppinger, "Product Design and Development", 4th Edition, McGraw-Hill Education, 2015.
- [9] Neville A. Stanton, "Human Factors in Consumer Products", Taylor & Francis, 1997.
- [10] Y. K. Å and B. D. Lowe, "Optimal cylindrical handle diameter for grip force tasks", *International Journal of Industrial Ergonomics*, vol. 35, pp. 495–507, 2005.
- [11] Gordon, Claire C. et al., "Anthropometric Survey of U.S. Personnel", *Summary Statistics Interim Report*, March 1989.
- [12] Department of Defense Human Factors Engineering Technical Advisory Group, USA, "Human Engineering Design Data Digest", 2010.