

# Multi-Layer Perceptron and Radial Basis Function Neural Network Models for Classification of Diabetic Retinopathy Disease Using Video-Oculography Signals

Ceren Kaya, Okan ErKaymaz, Orhan Ayar, Mahmut Özer

**Abstract**—Diabetes Mellitus (Diabetes) is a disease based on insulin hormone disorders and causes high blood glucose. Clinical findings determine that diabetes can be diagnosed by electrophysiological signals obtained from the vital organs. 'Diabetic Retinopathy' is one of the most common eye diseases resulting on diabetes and it is the leading cause of vision loss due to structural alteration of the retinal layer vessels. In this study, features of horizontal and vertical Video-Oculography (VOG) signals have been used to classify non-proliferative and proliferative diabetic retinopathy disease. Twenty-five features are acquired by using discrete wavelet transform with VOG signals which are taken from 21 subjects. Two models, based on multi-layer perceptron and radial basis function, are recommended in the diagnosis of Diabetic Retinopathy. The proposed models also can detect level of the disease. We show comparative classification performance of the proposed models. Our results show that proposed the RBF model (100%) results in better classification performance than the MLP model (94%).

**Keywords**—Diabetic retinopathy, discrete wavelet transform, multi-layer perceptron, radial basis function, video-oculography.

## I. INTRODUCTION

SINCE diabetic retinopathy which prevents vision because of blood leaking from the eye vessels by retinal swelling, early diagnosis is significant. A variety of devices such as fundus fluorescein angiography, optical coherence tomography provides information only when disease complications occur [1]. If methods are developed to detect differences in retinal tissue before complications, specialist doctors may have the ability to intervene the disease early. When the literature is examined; studies on diabetic retinopathy involve the use of artificial intelligence techniques in the field of image processing by using Electro-oculography (EOG) and VOG signals [2]. Priya et al. compared the methods of probabilistic neural networks with support vector

machine during the identification and classification of diabetic retinopathy by using fundus images [3]. Rajput et al. used wavelet transform and feature-mean clustering algorithm in feature extraction of retinal fundus images belonging to diabetic retinopathy patients [4]. Noronha et al. extracted the features of fundus images with discrete wavelet transform and classified them with support vector machine [5]. Gürkan et al. compared the support vector machine and artificial neural network methods in classification of EOG signals [6]. Banerjee et al. classified the EOG signal by artificial neural networks using k-means clustering algorithm according to eye movements [7]. In a study by Lawrence et al., a human-computer interface was designed based on eye movements [8]. Kim et al. designed a decision support system by creating a new algorithm to distinguish EOG signal from other signals originating from eye movements [9]. The wavelet transform is a commonly used method for efficiently signal analysis in time-domain. It exhibits the signals minutiae in the multi-resolution analysis. In this context, the wavelet transform has shown successful results in waveform detection of EOG signals [10].

This study aimed to exhibit a decision support system which could classify individuals with or without diabetic retinopathy by using horizontal and vertical VOG signal. Moreover, the model can detect levels of diabetic retinopathy. These are defined as NPDR (Non-Proliferative Diabetic Retinopathy) and PDR (Proliferative Diabetic Retinopathy). The data has been subjected to pre-processing, in which the attributes were determined by the discrete wavelet transform (DWT) method. The classification performance of normalized data which obtained with DWT method has been investigated by using multi-layer perceptron and radial basis function neural networks.

## II. VOG SIGNAL MEASUREMENT AND FEATURE EXTRACTION

We prepare a VOG signal dataset which is obtained by using a 200 Hz internal monitoring camera located in the Metrovision MonPackOne EOG device to measure accurately the performance of proposed model. The observed dataset includes 21 samples and three classes (Healthy: 7, NPDR: 7 and PDR: 7). Each sample has 25 features calculated with wavelet transform. Figs. 1-3 show example of the Healthy, NPDR and PDR VOG signals and wavelet transform

Ceren Kaya is with the Department of Biomedical Engineering, Bülent Ecevit University, Zonguldak, Turkey (corresponding author, e-mail: [ceren.kaya@beun.edu.tr](mailto:ceren.kaya@beun.edu.tr)).

Okan ErKaymaz is with the Department of Computer Engineering, Bülent Ecevit University, Zonguldak, Turkey (e-mail: [okan.erkaymaz@beun.edu.tr](mailto:okan.erkaymaz@beun.edu.tr)).

Orhan Ayar is with the Department of Ophthalmology, Bülent Ecevit University, Zonguldak, Turkey (e-mail: [orhanayar@gmail.com](mailto:orhanayar@gmail.com)).

Mahmut Özer is with the Department of Electrical and Electronics Engineering, Bülent Ecevit University, Zonguldak, Turkey (e-mail: [mahmutozer2002@yahoo.com](mailto:mahmutozer2002@yahoo.com)).

coefficients for subjects, respectively.

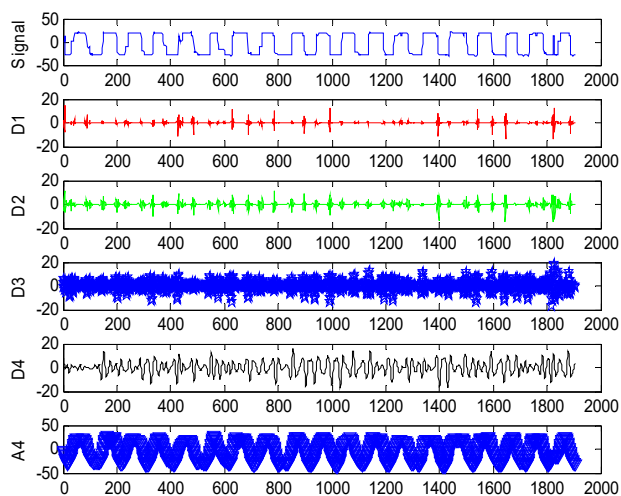

Fig. 1 Healthy VOG signal and wavelet coefficients

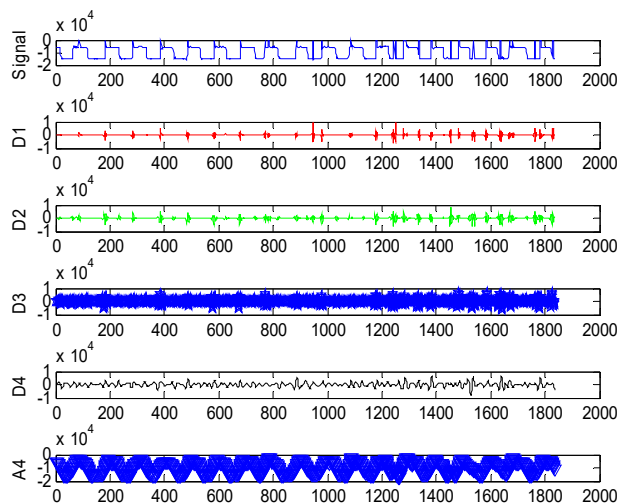

Fig. 2 NPDR VOG signal and wavelet coefficients

## II. DISCRETE WAVELET TRANSFORM

Wavelet transform is derived as an alternative method for traditional Fourier transform. The most important advantage

of wavelet transform is the use of different window sizes at high and low frequencies. This gives a good time-frequency resolution over the entire frequency range [11]. In biomedical signal processing, DWT is preferred rather than continuous wavelet transform (CWT) due to the nature of biological signals. Calculation of wavelet coefficients is both difficult and time consuming, so the original signal is divided a certain scale by wavelet transform, defined as “Multiresolution Signal Decomposition” (Fig. 4) [12].

As seen in Fig. 4, the original signal ( $x[n]$ ) is passed through a high pass filter ( $g[n]$ ) and a low pass filter ( $h[n]$ ) to acquire the detail (D1-D2-D3) and approximation (A3) coefficients, respectively. Then, the same operation is continued to determine decomposition level only for approximation coefficients. The number of decomposition levels and proper wavelet selection are very significant in DWT method. The number of decomposition levels is selected based on the dominant frequency components of the signal [12]. In this study, Coiflet wavelet (Coif4) is used to calculate wavelet coefficients of VOG signals. Calculated coefficients are taken as feature vectors. The following statistical features are used to reduce the feature vectors' dimension and represent the time-frequency distribution of VOG signals:

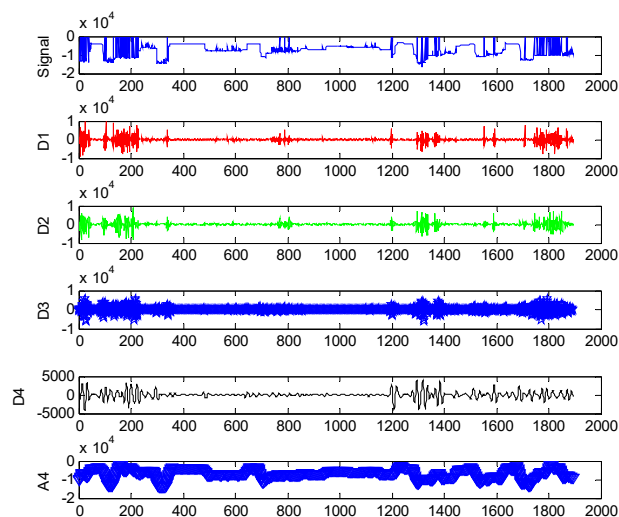

Fig. 3 PDR VOG signal and wavelet coefficients

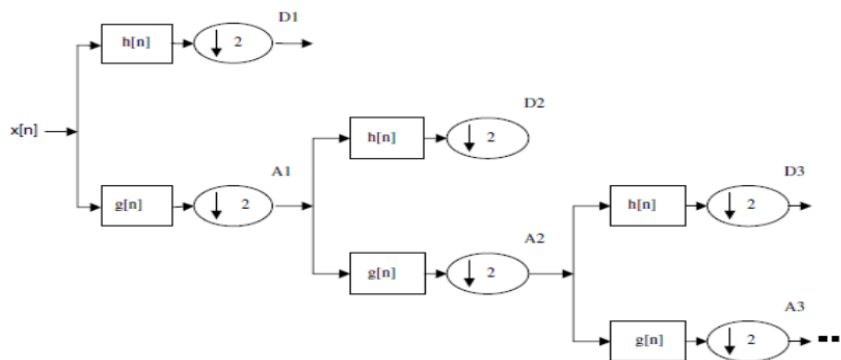

Fig. 4 Sub-band decomposition by DWT method [12]

1. Maximum of the coefficients in each sub-band,
  2. Minimum of the coefficients in each sub-band,
  3. Mean of the absolute values of the coefficients in each sub-band,
  4. Standard deviation of the coefficients in each sub-band,
  5. Variance of the coefficients in each sub-band.
- An example of statistical feature vectors is shown in Table I.

TABLE I  
 STATISTICAL FEATURE VECTORS OF VOG SIGNALS

Maximum	Minimum	Mean	Standard Deviation	Variance
2311,57864	2516,637231	3614,943575	3245,514478	8920,568456
2285,40764	2516,064655	2600,89071	3232,573107	4522,947374
9657,531623	9116,912299	5635,141089	3974,550058	2099,369294
1786,720798	2555,194281	3449,405265	3651,791557	7741,847788
9555,400599	8825,495034	6234,755305	6294,411453	2629,771102

### III. MULTI-LAYER PERCEPTRON NEURAL NETWORK

Multi-layer perceptron neural networks (MLP) are mathematical models that are inspired by information processing way of biological nervous systems such as brain. MLP architecture consists of many interconnected neurons working together to solve certain problems. These modules are structured for specific applications such as pattern recognition or data classification via learning process [13], [14]. For this reason, MLP network model should be trained with a data set. In the prepared model, the data normalized in [0,1] range is used as the input of MLP. With the normalized data set, the network is trained for 200 iterations.

In the training process, the problem of over learning is avoided by using the cross-validation method. In this study, the Levenberg-Marquardt back propagation algorithm, which is the fastest of MLP learning algorithms, is used. Regression coefficient, mean square error, mean absolute error, accuracy, precision, sensitivity and specificity values are calculated with 80% training and 20% test of dataset to find out the model performance.

### IV. RADIAL BASIS FUNCTION NEURAL NETWORK

Radial Basis Function (RBF) neural networks can be used in large applications, because they can approach any function, and their training is faster than MLP neural networks. This rapid learning comes from the fact that RBFs have only two layers of parameters (the width of centroids and weights) and each layer can be determined sequentially.

MLP is trained by supervised techniques, that the weights are calculated by minimizing a nonlinear cost function. Unlike MLP, the learning of the RBF neural network can be divided into unsupervised and linear supervised sections. Update techniques for unsupervised parameters are relatively fast and have forward propagation. The supervised learning portion includes a linear problem solution to avoid the local minima problem.

Training process of RBF neural networks can be described in three stages [15]:

1. Locate the centers ( $C_i$ ) of the radial functions (Gaussian function).
2. Determine their widths ( $\sigma_i$ ).
3. Determine the weight of the network ( $\lambda_j$ ) between radial function layer and output layer.

In training process, the RBF network comprises neurons of two layers (input and hidden layers). The output cells perform a linear combination of nonlinear functions provided by the neurons in the hidden layer. The RBF network transfer function is defined as in (1):

$$F(x) = \sum_{j=1}^M \lambda_j \varphi_j(\|x - c_j\|) + \sum_{i=1}^d a_i x_i + b \quad (1)$$

where M is number of Centers ( $C_j$ ), d is dimension of input variables,  $\|(\cdot)\|$  denotes the Euclidean distance,  $a_i$  and b are weights of the linear and independent terms respectively, and  $\varphi_i$  represents nonlinear function of the network, which is calculated by (2):

$$\varphi_j(\|x - c_j\|) = \exp\left(-\frac{\|x - c_j\|^2}{2\sigma_j^2}\right) \quad (2)$$

The network parameters are:  $C_j$ ,  $\sigma_j$  and  $\lambda_j$ , the  $C_j$  centers are determined and adapted respectively using unsupervised learning with (3) and (4):

$$d_2(x^i, C^j) = \sqrt{\sum_{k=1}^D (x_k^i - c_k^j)^2} = \|x^i - C^j\| = (x^i - C^j)^T (x^i - C^j) \quad (3)$$

$$C^k(t+1) = C^k(t) + \alpha(t) * (x^i - C^k) \quad (4)$$

where  $\alpha(t)$  is a decreasing factor of time adaptation, with  $0 < \alpha(t) < 1$ , and  $\sigma_j$  is adapted with (5):

$$\sigma = \frac{d_{\max}}{\sqrt{2M}} \quad (5)$$

where M is the number of centroids, and  $d_{\max}$  is maximum distance between any pair of centroids.

### V. RESULTS

In the study, VOG signals are first taken. Approximation and detail coefficients are obtained by DWT method. Then, the statistical features of these coefficients are calculated. Twenty-five statistical features obtained were normalized and the data set was created.

MLP model with 25 inputs, 1 hidden layer and 1 output is created. For this topology, the dataset is divided into two parts: training and testing by cross-validation method. To find the number of hidden layer neurons, a hidden layer experiment is performed. In this experiment, the effect of changing hidden

layer neurons in the MLP topology is investigated with Mean Square Error (MSE) when 80% of the data set is used for training and the remaining 20% was used for testing. The obtained result is shown in Fig. 5.

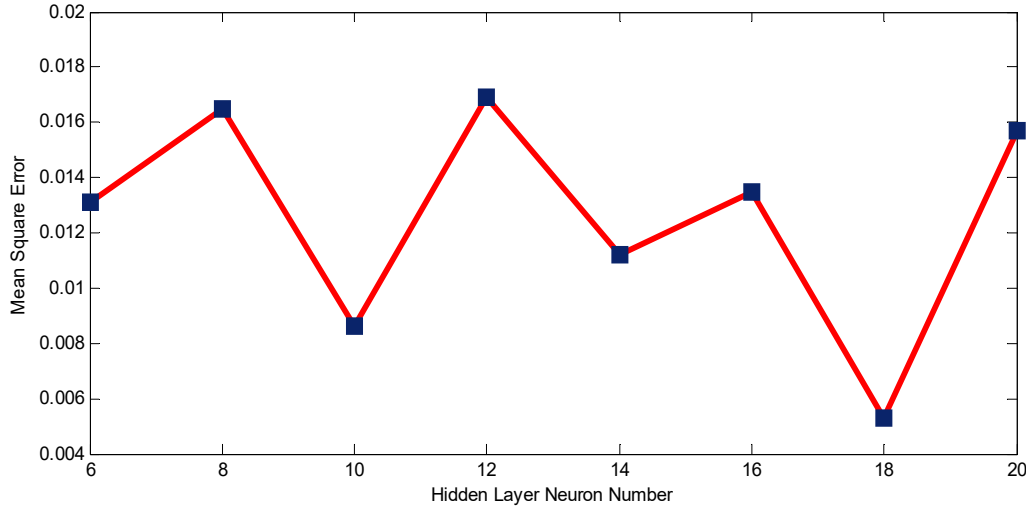

Fig. 5 Hidden layer neuron number vs. Mean square error

As seen in Fig. 5, the MLP topology with 18 neurons in hidden layer has the best performance. Therefore, we focus on this topology in our models (25-18-1). After this process, we train the MLP and RBF models with training dataset (80% of dataset). We perform test phase with 20% of dataset for these models. In the test phase, the error analysis of the models is presented in Tables II and III. It has seen that RBF model (0) has the better mean error performance than the MLP model (0.0823) and has higher correlation than the MLP model for each eye direction.

TABLE II  
MLP MODEL ERROR ANALYSIS

MLP	R	MSE	MAE
LEFT HORIZONTAL	0.94531	0.0195	0.1072
RIGHT HORIZONTAL	0.93782	0.0206	0.0956
LEFT VERTICAL	0.93003	0.0244	0.0863
RIGHT VERTICAL	0.94954	0.0178	0.0796

TABLE III  
RBF MODEL ERROR ANALYSIS

RBF	R	MSE	MAE
LEFT HORIZONTAL	1	0	0
RIGHT HORIZONTAL	1	0	0
LEFT VERTICAL	1	0	0
RIGHT VERTICAL	1	0	0

In addition, we determine the classification performance for each model by using the accuracy method (the confusion matrix). The method expressions are given as follow in (6)-(9) (FN: False Negative, FP: False Positive, TN: True Negative, TP: True Positive):

$$Accuracy(\%) = 100 * \frac{TP + TN}{TP + TN + FP + FN} \quad (6)$$

$$Precision(\%) = 100 * \frac{TP}{TP + FP} \quad (7)$$

$$Sensitivity(\%) = 100 * \frac{TP}{TP + FN} \quad (8)$$

$$Specificity(\%) = 100 * \frac{TN}{TN + FP} \quad (9)$$

The results are presented in Table IV. The RBF model has more success in classification with an accuracy of 100% than the MLP with an accuracy of 94%. It is also observed that the RBF model displays robust character to recognize of diabetic retinopathy by having a sensitivity of 100% and a specificity of 100%.

TABLE IV  
STATISTICAL ANALYSIS OF MLP AND RBF MODELS

Model	Eye Direction	Accuracy (%)	Precision (%)	Sensitivity (%)	Specificity (%)
MLP	Left Horizontal	95.24	87.5	100	92.86
	Right Horizontal	95.24	100	85.71	100
	Left Vertical	95.24	87.5	100	92.86
	Right Vertical	90.48	77.78	100	85.71
	Left Horizontal	100	100	100	100
RBF	Right Horizontal	100	100	100	100
	Left Vertical	100	100	100	100
	Right Vertical	100	100	100	100

Finally, we also analyze the level of disease with three classes in the diagnosis of diabetic retinopathy and the

calculated confusion matrix results are presented graphically for each model in Fig. 6.

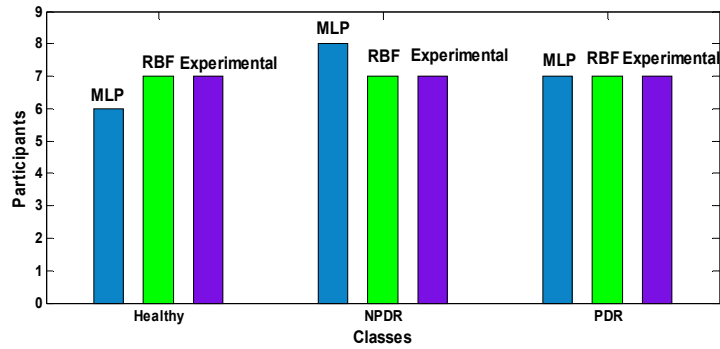

(a)

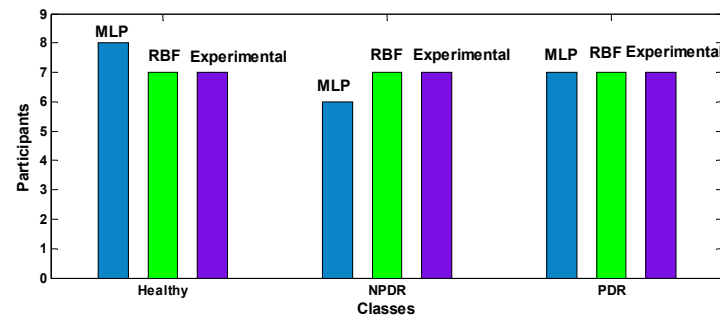

(b)

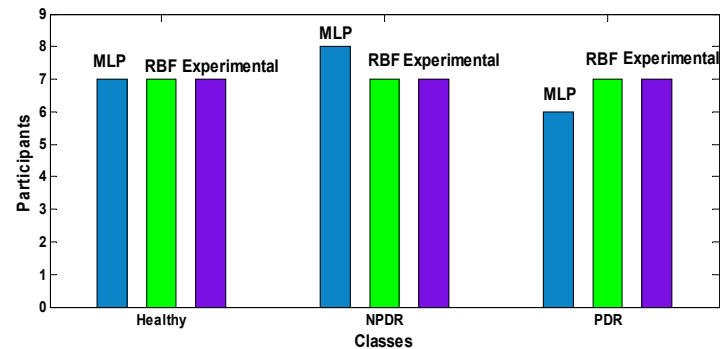

(c)

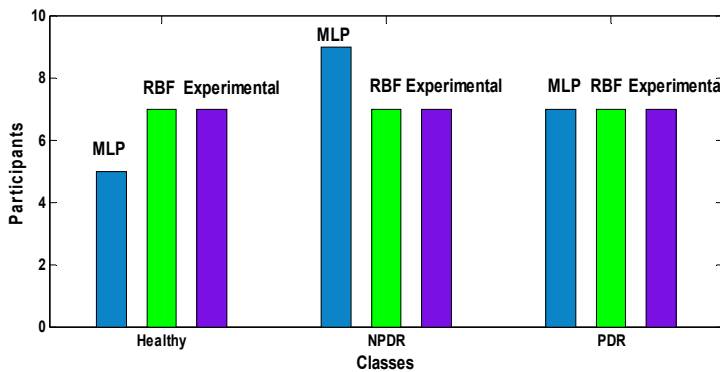

(d)

Fig. 6 Confusion matrix results obtained for 80% -20% data set; (a) Left horizontal (b) Right horizontal (c) Left vertical (d) Right vertical

## VI. CONCLUSION

Our study has shown that it is feasible to extract VOG signal features by using DWT and that can be used as a good classification tool. It has been observed that the magnitudes of statistical features obtained with approximation and detail coefficients of the wavelet transform have remarkable information to recognize healthy, NPDR and PDR signals. The proposed model illustrates a clear advantage to classify the level of diabetic retinopathy with VOG signals. Our results indicate that RBF classification model exhibits better classification performance than the MLP model. As a future work, we plan to use different feature extraction methods for pre-processing phase and research detectability of various eye diseases by using VOG signal.

## ACKNOWLEDGMENT

This research is approved by Clinical Research Ethics Committee and supported by Scientific Research Projects Commission (BAP) of Bülent Ecevit University.

## REFERENCES

- [1] Vallabha, D., Dorairaj, R., Namuduri, K. and Thompson, H., "Automated Detection and Classification of Vascular Abnormalities in Diabetic Retinopathy", Proceedings of 13th IEEE Signals, Systems and Computers, 1625-1629, 2004.
- [2] Walter, T., Klein, J. C., Massin, P. And Erginay, A., "A Contribution of Image Processing to The Diagnosis of Diabetic Retinopathy-Detection of Exudates in Colour Fundus Images of The Human Retina", IEEE Transactions on Medical Imaging, 22(10): 1236-1243, 2002.
- [3] Priya, R. and Aruna, P., "Diagnosis of Diabetic Retinopathy Using Machine Learning Techniques", ICTACT Journal on Soft Computing, 3(4): 563-575, 2013.
- [4] Rajput, Y. M., Manza, R. R., Patwari, M. B., Rathod, D. D., Borde, P. L. and YML Pawar, P. L., "Detection of Non-Proliferative Diabetic Retinopathy Lesions Using Wavelet and Classification Using K-Means Clustering", International Conference on Communication Networks (ICCN), 381-387, 2015.
- [5] Noronha, K., Acharya, U. R., Nayak, K. P., Kamath, S. and Bhandary, S. V., "Decision Support System for Diabetic Retinopathy Using Discrete Wavelet Transform", Journal of Engineering in Medicine, 227(3): 251-261, 2012.
- [6] Gürkan, G., Gürkan, S. ve Uşaklı, A. B., "EOG Sinyalleri İçin Sınıflandırma Algoritmalarının Karşılaştırılması", 20. IEEE Sinyal İşleme ve İletişim Uygulamaları Kurultayı (SIU), 1-4, 2012.
- [7] Banerjee, A., Datta, S., Pal, M., Konar, A., Tibarewala, D. N. and Janarthanan, R., "Classifying Electrooculogram to Detect Directional Eye Movements", Int. Conf. on Comp. Intellig.: Model. Tech. and App. (CIMTA), 10: 67-75, 2013.
- [8] Lawrence, Y., Chun-Liang, H., Tzu-Ching, L., Jui-Sen, T. and Shih-Ming, C., "EOG-Based Human-Computer Interface System Development", Expert Systems with Applications, 37:3337-3343, 2009.
- [9] Kim, O., Doh, N. L., Youm, Y. and Chung, W. K., "Robust Discrimination Method of The Electrooculogram Signals for Human-Computer Interaction Controlling Mobile Robot", Intelligent Automation& Soft Computing, 13:319-336, 2013.
- [10] Goswami, J. C. and Chan, A. K., "Fundamentals of Wavelets", Second Edition, John Wiley&Sons, Inc., 2011.
- [11] Kaya, C., Erkaymaz, O., Ayar, O. ve Özer, M., "Ayrık Dalgacık Dönüşümü Kullanarak VideoOkülografi (VOG) Sinyallerinden Diyabetik Retinopati Hastalığının Fizyolojik Etkilerinin Belirlenmesi", Tıp Teknolojileri Ulusal Kongresi (TIPEKNO), 142-145, 2016.
- [12] Subaşı, A., "EEG Signal Classification Using Wavelet Feature Extraction and A Mixture of Expert Model", Expert Systems with Applications, 32: 1084-1093, 2007.
- [13] Kaya, C., Erkaymaz, O., Ayar, O. ve Özer, M., "Video-Okülografi (VOG) Sinyallerinden Diyabetik Retinopati Hastalığının Yapay Sinir Ağları İle Tespiti", 25. IEEE Sinyal İşleme ve İletişim Uygulamaları

Kurultayı (SIU), 1-4, 2017.

- [14] Erkaymaz, H., Özer, M. ve Orak, İ. M., "Detection of Directional Eye Movements Based on The Electrooculogram Signals through an Artificial Neural Network", Chaos Solitons&Fractals, 56: 202-208, 2015.
- [15] T. Xie, H. Yu and B. Wilamowski, "Comparison between Traditional Neural Networks and Radial Basis Function Networks," IEEE International Symposium on Industrial Electronics, 1194-1199, 2011.