

Exergy Based Performance Analysis of a Gas Turbine Unit at Various Ambient Conditions

Idris A. Elfeituri

Abstract—This paper studies the effect of ambient conditions on the performance of a 285 MW gas turbine unit using the exergy concept. Based on the available exergy balance models developed, a computer program has been constructed to investigate the performance of the power plant under varying ambient temperature and relative humidity conditions. The variations of ambient temperature range from zero to 50 °C and the relative humidity ranges from zero to 100%, while the unit load kept constant at 100% of the design load. The exergy destruction ratio and exergy efficiency are determined for each component and for the entire plant. The results show a moderate increase in the total exergy destruction ratio of the plant from 62.05% to 65.20%, while the overall exergy efficiency decrease from 38.2% to 34.8% as the ambient temperature increases from zero to 50 °C at all relative humidity values. Furthermore, an increase of 1 °C in ambient temperature leads to 0.063% increase in the total exergy destruction ratio and 0.07% decrease in the overall exergy efficiency. The relative humidity has a remarkable influence at higher ambient temperature values on the exergy destruction ratio of combustion chamber and on exergy loss ratio of the exhaust gas but almost no effect on the total exergy destruction ratio and overall exergy efficiency. At 50 °C ambient temperature, the exergy destruction ratio of the combustion chamber increases from 30% to 52% while the exergy loss ratio of the exhaust gas decreases from 28% to 8% as the relative humidity increases from zero to 100%. In addition, exergy analysis reveals that the combustion chamber and exhaust gas are the main source of irreversibility in the gas turbine unit. It is also identified that the exergy efficiency and exergy destruction ratio are considerably dependent on the variations in the ambient air temperature and relative humidity. Therefore, the incorporation of the existing gas turbine plant with inlet air cooling and humidifier technologies should be considered seriously.

Keywords—Destruction, exergy, gas turbine, irreversibility, performance.

I. INTRODUCTION

GAS turbine (GT) power plants are used to generate electric power worldwide due to their low cost and short synchronization time. Different GT units, with various capacities ranging from 25 MW to 285 MW, are used in Libya [1]. These GTs supply up to 60% of nation's electricity demand. In addition, these GTs often run at off-design conditions because of their load change or ambient conditions.

The GT is composed of a compressor that supplies air at high pressure to the combustor that provides flue-gas at high pressure and temperature to the turbine. GTs output is directly proportional to the mass flow-rate of the compressor's inlet air

[2]. Despite the volume and speed of the air are constant, any short or long alteration in the ambient air parameters (i.e. temperature, relative humidity) considerably affects the GTs performance. Therefore, these different weather conditions should be taken into account when evaluating the overall performance of the GT plants. Furthermore, the merit of the GT system should be determined using exergy analysis since energy analysis tends to overestimate performance [3], [5].

Exergy is defined as the maximum possible reversible work obtainable in bringing the state of the system to equilibrium with the environment [3]. The exergy analysis is based on the second law of thermodynamics, while the energy analysis is based on the first law of thermodynamics. The loss of useful energy in power plants cannot be justified by the energy analysis, as it does not differentiate between the quality and quantity of energy [4]. Energy analysis presents only quantities results while exergy analysis presents qualitative results about actual energy consumption [4], [5].

The use of exergy concept has been widely used by many researchers in evaluating, optimizing and improving the GT plants. Balli et al. [6] carried out the exergy analysis of a GT cogeneration power plant; the results showed that 68% of the overall exergy destructed is occurring in the combustion chamber. Exergy based performance characteristics of heavy duty GT in part load operation conditions was investigated by Song et al. [7] and Aklilu et al. [8]. Oh et al. [9] analyzed the effect of ambient temperature and relative humidity on the exergy performance of 1000 KW GT cogeneration unit and Abam et al. [10] studied the effect of ambient temperature on the performance of an in-service GT unit using exergy method. According to them, exergy does not only address the impact of energy resource use on the environment, but also proves to be a suitable technique for promoting the goal of improved energy conversion. Tara et al. [11] and Egware [12] showed that exergy destruction was a valuable tool when comparing performances of compressors, combustors and turbines with different pressure ratios and compressor inlet temperatures. De Sa et al. [13] considered specific GTs installed at the Dewha city (Dudi) Power Station. They investigated the performance of the units at various ambient temperatures. They concluded that for every 1 °C rise in ambient temperature, above ISO conditions, the unit loss is 0.1% in thermal efficiency and 1.47 MW in the power output. Fellah [14] evaluated the performance of a 500 MW combined cycle power plant in Libya. He reported a drop of about 20% of the rated power capacity of the combined cycle at ISO conditions when the ambient temperature reaches 40 °C. The effects of ambient temperature and relative-humidity on the

Idris A. Elfeituri is with the Department of Mechanical Engineering, University of Benghazi, Benghazi City, P.O. Box: 32834 Libya (phone: +218-94-471-0641; e-mail: idrisffff@yahoo.com).

thermodynamic performance of GT have been reported by several authors such as Hadik [15] and Bassam [16]. They concluded that, ambient air temperature has the greatest effect on GT power output and thermal efficiency. The effect of relative humidity on both power output and thermal efficiency is negligible, especially at low ambient air temperature values.

Finally, although there are a lot of studies on this topic, the effect of ambient temperature and relative humidity on exergy destruction of GT plants is not widely covered. Therefore, the objective of the present work is to analyze a 285-MW GT unit located in Sarir-Libya. Exergy destruction ratio and efficiency of the entire plant and its individual components will be determined at plant full load capacity and at varied ambient air temperatures and relative humidity values.

II. PLANT DESCRIPTION

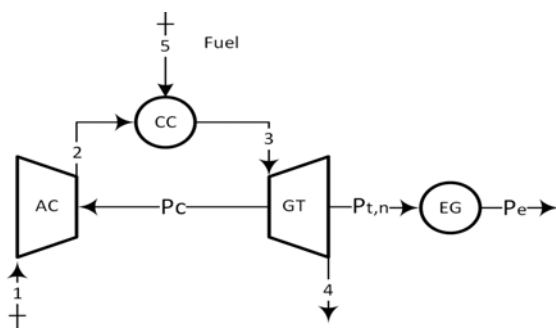

Fig. 1 Schematic diagram of the selected GT unit

TABLE I
 GT UNIT DESIGN PARAMETERS [17]

Component	Parameter	Value	Units
Air Compressor	Inlet temperature: T_1	15.0	°C
	Relative humidity: ϕ	60.0	%
	Inlet pressure: p_1	1.013	bar
	Pressure ratio: π_c	17.5	[-]
	Mass flow-rate of air: \dot{m}_1	672	kg/s
	Compression efficiency: η_c	88.8	%
	Mechanical efficiency: η_m	98.5	%
	Number of stages	15	[-]
Combustion Chamber	Speed	3000	rpm
	Pressure drop: Δp_{CC}	0.3	bar
	Outlet temperature: T_3	1242	°C
	Specific heat of fuel: C_{p_f}	2.25	kJ/kg.°C
	Gas constant of fuel: R_f	0.52	kJ/kg.°C
	Heat value (NG): LHV	45.78	MJ/kg
	Efficiency: η_{CC}	88.0	%
	Number of burners	24	[-]
GT	Inlet pressure: p_3	17.43	bar
	Outlet pressure: p_4	1.023	bar
	Expansion efficiency: η_t	91.0	%
	Mechanical efficiency: η_m	98.5	%
	Generator efficiency: η_G	98.4	%
	Number of stages	4	[-]
	Speed	3000	rpm

The power plant is located 400 m above sea level in the city of Sarir, at south of Libya, 300 km from the Mediterranean coast. It started operation in 2010. The power house consists of three Siemens GT units, type SGT5-PAC 4000F, and each unit with 285 MW capacity [17]. The schematic diagram of one 285 MW unit is shown in Fig. 1.

Generally the GT power plants consist of four major components namely the air compressor (AC), combustion chamber (CC), turbine and electrical generator (EG). The basic principle of the GT operation is Brayton cycle. Air entering the AC at point 1 is compressed to some higher pressure (app. 17 bar) and the compression raises the air temperature at point 2. After compression, the compressed air then passes through the CC where fuel is injected and burned. The combustion system is designed to provide mixing, burning, dilution and cooling. Thus, by the time the combustion leaves the CC and enters the turbine at point 3, it is at a mixed average temperature. Hot gases leaving the CC are expanded in the GT from point 3 to 4 thereby producing mechanical power and finally discharged to the atmosphere. A portion of mechanical power produced in the GT is used to drive the AC and the balance is converted into electrical power. The design data of the GT unit are summarized in Table I.

III. MATHEMATICAL MODELING

The mass, energy and exergy balance equations for different components of the GT unit are computed on the basis of following assumptions:

- 1) Only temperature and relative humidity are considered for ambient conditions,
- 2) Fixed turbine inlet temperature at 1242 °C, and plant load at 100%, compressor inlet guide vanes are fully open, and they are kept constant during the analysis,
- 3) The fuel injected to the CC is assumed to be natural gas,
- 4) The dry and humid air and combustion products were considered as ideal gas mixtures.
- 5) The GT unit's speed is constant (3000 rpm).
- 6) Kinetic and potential energies as well as auxiliary electrical power are neglected.
- 7) As the source of the air is a reference state (the ambient air), the exergy flow-rate value of the air at the AC inlet is assumed to be zero,
- 8) The ISO ambient conditions are 15 °C, 1.013 bar and 60% relative humidity.

Fig. 2 shows the temperature-entropy diagram for this cycle. The ideal and actual processes are represented by dashed and solid lines, respectively. With regard to Fig. 1, each component in the power plant was considered as a control volume and analyzed separately. The analysis for each control volume at steady state can be expressed as [18], [19]:

A. Air Compressor Model

Using the relations for ideal gas and knowing the air inlet temperature, pressure ratio (π_c) and compressor efficiency (η_c), the outlet temperature (T_2) can be calculated as:

$$T_2 = T_1 \times \left[1 + \frac{\pi_c^{\frac{\gamma_h - 1}{\gamma_h}} - 1}{\eta_c} \right] \quad (1)$$

The isentropic exponent (γ_h) for humid-air is given as;

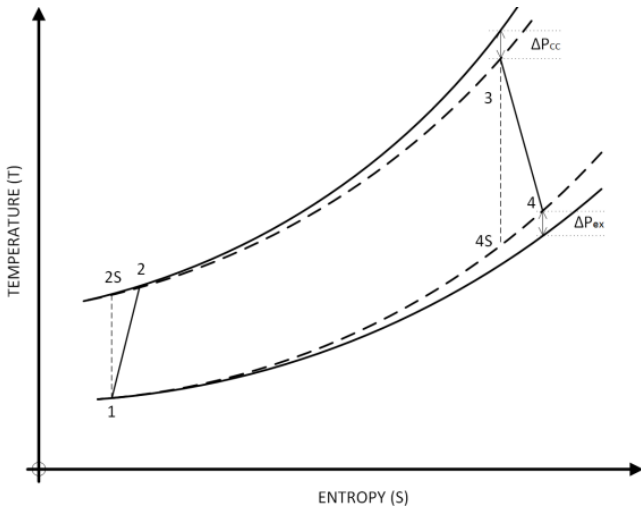

Fig. 2 Temperature-entropy diagram

$$\gamma_h = Cp_h / (Cp_h - R_h) \quad (2)$$

where, Cp_h is the mean specific heat of humid-air, determined as a function of the average temperature (T) across the compressor, and calculated as [15];

$$Cp_h = Cp_a + \omega \times Cp_v \quad (3)$$

where Cp_a is the specific heat capacity of dry-air which can be fitted by (4) for the range of $200 \text{ K} < T < 800 \text{ K}$ [15];

$$Cp_a = \left[28.11 + \frac{1.967 \times T}{10^3} + \frac{4.802 \times T^2}{10^6} - \frac{1.966 \times T^3}{10^9} \right] / 28.97 \quad (4)$$

and Cp_v is the specific heat capacity of vapor which can be fitted by (5) for the range of $200 \text{ K} < T < 800 \text{ K}$ [15];

$$Cp_v = \left[32.24 + \frac{1.923 \times T}{10^3} + \frac{1.055 \times T^2}{10^5} - \frac{4.187 \times T^3}{10^9} \right] / 18.01 \quad (5)$$

The values, 28.97 and 18.015 are the molecular weights of dry-air and vapor respectively.

The gas constant (R_h) of humid-air can be calculated as:

$$R_h = \frac{8.3143}{MMW} \quad (6)$$

where, MMW is the molecular weight of humid-air, and is given by:

$$MMW = \frac{1}{\left(\frac{VMF}{18.015}\right) + \left(\frac{AMF}{28.97}\right)} \quad (7)$$

VMF is the vapor mass fraction, and is given by:

$$VMF = \frac{\omega}{(1+\omega)} \quad (8)$$

AMF is the dry-air mass fraction, and is given by:

$$AMF = 1 - VMF \quad (9)$$

The specific humidity (ω) is defined as the ratio of vapor mass to dry-air mass [18]:

$$\omega = 0.622 \times \frac{p_v}{p_a} = \frac{\phi \times p_{sat}}{(p_h - p_v)} \quad (kg_v/kg_a) \quad (10)$$

$$p_v = \phi \times p_{sat} \quad (11)$$

where, p_h is the total pressure of the humid-air, p_{sat} is the saturation pressure at the temperature of the humid-air ($T_a = T_v = T_i$), p_v and p_a are the partial pressures of dry-air and vapor in the humid-air respectively, and ϕ is the relative humidity of the humid-air.

The compressor power (P_c) working with humid-air between points 1 and 2 is calculated from mass flow-rate of humid-air and enthalpy change across the compressor [13]:

$$P_c = \frac{1}{\eta_c} \times [\dot{m}_a \times Cp_a \times (T_2 - T_1) + \dot{m}_v \times (h_{v,2} - h_{v,1})] \quad (12)$$

where, \dot{m}_a is the dry-air mass flow-rate and for a given operating condition it equals to:

$$\dot{m}_a = \frac{V_r \times \rho_h}{(1+\omega)} \quad (13)$$

V_r is the volume flow-rate of humid-air at reference condition, and ρ_h is the density of humid-air. Using the ideal gas relations, they can be evaluated as [13]:

$$V_r = \frac{\dot{m}_{h,r} \times R_{h,r} \times T_{a,r}}{p_{h,r}} \quad (14)$$

$$\rho_h = \frac{p_h}{R_h \times T_h} \quad (15)$$

The mass flow-rate of water vapor (\dot{m}_v) is calculated by:

$$\dot{m}_v = \dot{m}_a \times \omega \quad (16)$$

The total mass (\dot{m}_h) of working fluid of humid-air flowing through the compressor equal to:

$$\dot{m}_h = \dot{m}_a + \dot{m}_v = \dot{m}_a \times (1 + \omega) \quad (17)$$

$h_{v,i}$ and $h_{v,2}$ in (12) are the enthalpies of water vapor at inlet and outlet of the compressor, respectively, and evaluated approximately as [13]:

$$h_{v,i} = 2501.3 + 1.8723 \times T_i \quad (18)$$

where (i) refers to state points 1, 2 or 3, and T is the temperature of vapor in °C.

B. Combustion Chamber Model

In the CC, inlet fluids are the humid-air coming from the compressor and the fuel added for the combustion process. The exit fluids are the flue gas and water vapor (combustion products). The basic principle of operation of a CC is based on the energy balance principle and is given by;

$$\dot{m}_a(h_2 - h_1) + \dot{m}_v h_{v2} + \dot{m}_f LHV \eta_{cc} + \dot{m}_f h_f = (\dot{m}_a + \dot{m}_f)(h_3 - h_1) + \dot{m}_v h_{v3} \quad (19)$$

after manipulating and dividing (19) by \dot{m}_a , the fuel mass flow-rate (\dot{m}_f) is expressed as:

$$\dot{m}_f = \frac{\dot{m}_a (Cp_g T_3 - Cp_a T_2) + \dot{m}_v (h_{v3} - h_{v2})}{(LHV \eta_{cc} + Cp_f T_f - Cp_g (T_3 - T_1))} \quad (20)$$

The total heat supplied by fuel (Q_f) in the CC is given by;

$$Q_f = \dot{m}_f \times LHV \quad (21)$$

where, (η_{cc}) is the combustor efficiency, h_{w3} is the enthalpy of saturated vapor at the outlet of the CC and Cp_g is the mean specific heat of combustion gases, determined as a function of the average temperature (T) across the turbine [20];

$$Cp_g = \left[\left(\frac{9.91615}{10} \right) + \left(\frac{6.99703 \times T}{10^5} \right) + \left(\frac{2.7129 \times T^2}{10^7} \right) - \left(\frac{1.22442 \times T^3}{10^{10}} \right) \right] \quad (22)$$

The losses inside the combustion chamber, which arise due pressure drop is taken into account and estimated by introducing the expression [5]:

$$\Delta p_{cc} = \Delta p_{cc,r} \times \left(\frac{\dot{m}_3}{\dot{m}_{3,r}} \right)^{1.8} \times \left(\frac{T_3 \times p_{3,r}}{T_{3,r} \times p_3} \right)^{0.8} \quad (23)$$

where \dot{m}_3 is the total mass flow-rate of combustion products entering to GT and is given by:

$$\dot{m}_3 = \dot{m}_4 = \dot{m}_a + \dot{m}_v + \dot{m}_f \quad (24)$$

The reference condition with index (r) is considered as the design condition in this study.

C. Turbine Model

Knowing the flue gases inlet temperature, pressure ratio (π_t) and turbine efficiency (η_t), the outlet temperature of the flue gases (T_4) can be calculated from [18]:

$$T_4 = T_3 \times \left[1 - \eta_t \times \left(1 - \frac{1}{\pi_t^{\frac{\gamma_g - 1}{\gamma_g}}} \right) \right] \quad (25)$$

The isentropic exponent (γ_g) for flue gases is:

$$\gamma_g = Cp_g / (Cp_g - R_g) \quad (26)$$

The gas constant of the flue gases (R_g) can be obtained using [20]:

$$R_g = 287.1 + 212.9 / AFR - 197.9 \times (1 / AFR)^2 \quad (27)$$

where AFR is the air to fuel ratio.

For the part-load analysis, the turbine inlet pressure (p_3) for considered choked condition is calculated from an improved Flugel formula as [21]:

$$p_3 = \left[\sqrt{\left[\left(\frac{\dot{m}_3}{\dot{m}_{3,r}} \right)^2 \times \left(\frac{T_{3,r}}{T_3} \right)^{0.5} \right]^2 \times (\pi_{t,r}^2 - 1) + 1} \right] \times p_4 \quad (28)$$

and the compressor outlet pressure (p_2) is given by:

$$p_2 = p_3 + \Delta p_{cc} \quad (29)$$

The total output mechanical power (P_t) of the GT is expressed as [18]:

$$P_t = (\dot{m}_a + \dot{m}_v + \dot{m}_f) \times Cp_g \times (T_4 - T_3) \times \eta_m \quad (30)$$

Hence the net mechanical power output ($P_{t,net}$) of GT:

$$P_{t,n} = P_t - P_c \quad (31)$$

The net electrical power output ($P_{e,net}$) produced from GT:

$$P_{e,net} = P_{t,net} \times \eta_g \quad (32)$$

D. Energy Performance Model

The overall energy efficiency (η_{en}) of the GT unit:

$$\eta_{en} = \left(\frac{P_{t,net}}{Q_f} \right) \times 100\% \quad (33)$$

Heat rate (HR) of the GT unit:

$$HR = \frac{3600}{\eta} \quad (34)$$

and specific fuel consumption (SFC) of the GT is:

$$SFC = \frac{HR}{LHV} \quad (35)$$

E. Exergy Performance Model

The exergy flow rate of fuel (EX_5) is given by [19]:

$$EX_5 = 1.06 \times \dot{m}_f \times LHV \quad (36)$$

The exergy flow rate for ideal gas at various state points in the cycle can be calculated by [19]:

$$EX_i = \dot{m}_i \times [(h_i - h_0) - T_0 \times (s_i - s_0)] \quad (37)$$

$$s_i - s_0 = Cp_i \times \ln \left(\frac{T_i}{T_0} \right) - R_i \times \ln \left(\frac{p_i}{p_0} \right) \quad (38)$$

where h_i and s_i are the enthalpy and entropy of the substance (i) respectively, and h_0 , s_0 and T_0 are those at ambient condition. Using (37), the values of exergy flow rates for all points are calculated. The exergy: destruction rate, destruction

ratio and efficiency for plant components and for whole plant can be calculated using relations in Table II [2], [4], [19].

TABLE II
 EXERGY DESTRUCTION RATE, DESTRUCTION RATIO AND EFFICIENCY EQUATIONS FOR PLANT COMPONENTS

Component	Exergy destruction rate	Exergy destruction ratio	Exergy efficiency
Compressor	$EXD_c = P_c + EX_1 - EX_2$	$EXDR_c = EXD_c/EX_5$	$\eta_{ex,c} = (EX_2 - EX_1)/P_c$
Combustor	$EXD_{cc} = EX_2 - EX_3 + EX_5$	$EXDR_{cc} = EXD_{cc}/EX_5$	$\eta_{ex,cc} = EX_3/(EX_2 + EX_5)$
Turbine	$EXD_t = EX_3 - EX_4 - P_t$	$EXDR_t = EXD_t/EX_5$	$\eta_{ex,t} = P_t/(EX_3 - EX_4)$
Generator	$EXD_{EG} = P_{t,net} - P_{e,net}$	$EXDR_{EG} = EXD_{EG}/EX_5$	$\eta_{ex,EG} = P_{e,net}/P_{t,net}$
Total Plant	$EXD_{total} = EXD_c + EXD_{cc} + EXD_t + EXD_{EG}$	$EXDR_{total} = EXD_{total}/EX_5$	$\eta_{ex,total} = P_{t,n}/EX_5$

IV. ANALYSIS PROCEDURE

The impacts of ambient air temperature and relative humidity at full-load on the exergy-based performance of a typical GT unit have been studied. For this purpose a full computer program has been constructed using the thermodynamic model derived. The computational procedure of the program is shown in Fig. 3. At the beginning, the values of ambient air temperature and relative humidity were assumed, and the compressor outlet pressure (p₂) was estimated. With this estimate the thermodynamic properties including exergy flow rates are calculate at every state point in Fig. 1. By setting up and solving (1)-(38), improved value for p₂ has been obtained. These steps were repeated until the solution has been reached the required accuracy.

V. RESULTS AND DISCUSSION

A. Reference Operating Condition

The reference operating condition is fixed at the ambient conditions (ISO) of 15 °C and 60% RH, and 100% load. Exergy balance for the components of the GT plant and of the overall plant is performed and the exergy flow rates crossing the boundary of each component of the plant, together with the exergy destruction rate, exergy destruction ratio and exergy efficiency of each component are calculated and shown in Figs. 4-6. From the figures, it can be observed that the major exergy losses of the GT unit are due to the exergy destruction in the CC and exergy loss in the exhaust gases. The total exergy destruction rate in the plant is found to be 483.3 MW (63% of input fuel exergy). The turbine is found to have the highest exergy efficiency of 95%. The exergy efficiency of the combustion chamber is much lower than that of other plant components (highest exergy destruction rate). This is due to the fact that the chemical reaction and the large temperature difference between the flame and working fluid are the main source of irreversibility in this section. Its value is calculated as 70.6%. The exergy efficiency of the air compressor is calculated as 93.6% and of the overall plant is found to be 37.1%. Fig. 6 shows exergy destruction ratio in each component based on the obtained results. Comparing the components of the GT unit also shows that the largest value of exergy destruction ratio occurs in CC, followed by exhaust gases which linked to 26.8% of destroyed and rejected gases. In contrast, the least value of exergy destruction ratio is found in the AC and turbine respectively. The values of components and total plant exergy destruction, exergy efficiency and exergy destruction ratio are in the same range as in [10]-[12].

Open Science Index, Energy and Power Engineering Vol:11, No:6, 2017 publications.waset.org/10007953.pdf

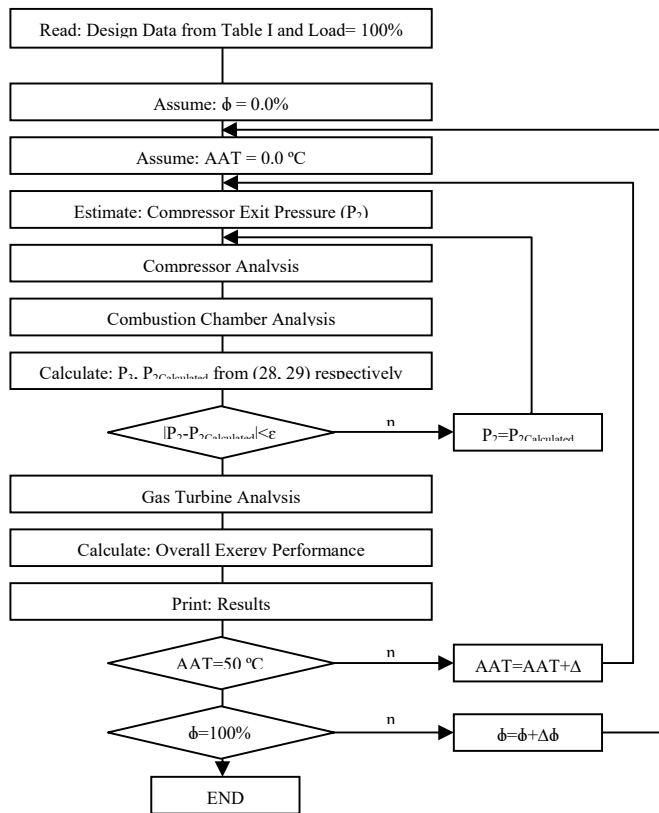

Fig. 3 Flow chart of the performance prediction program for the GT unit

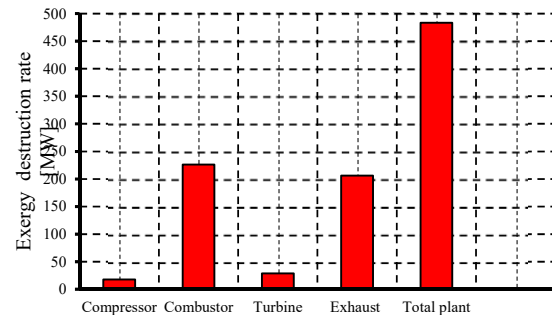

Fig. 4 Exergy destruction rate of Sarir GT plant and its components at design condition

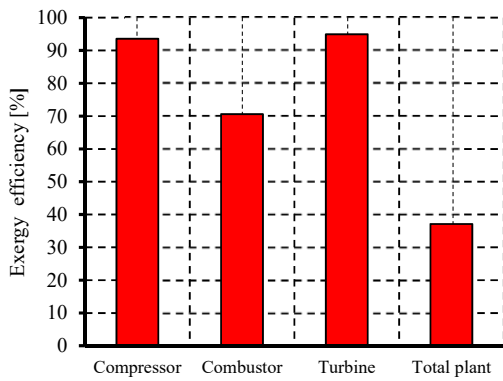

Fig. 5 Exergy efficiency of Sarir GT plant and its components at design condition

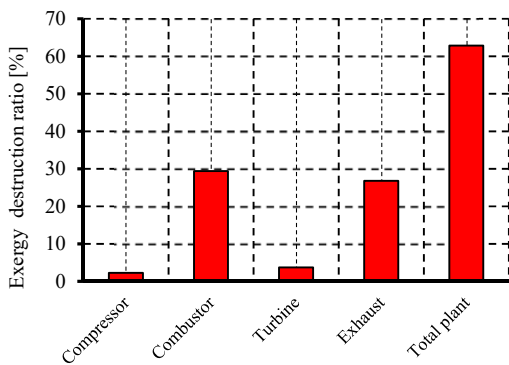

Fig. 6 Exergy destruction ratio of Sarir GT plant and its components at design rated condition

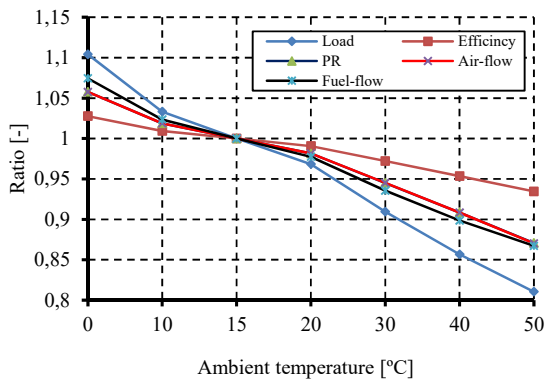

Fig. 7 Sarir GT performance versus ambient temperature, at $\phi=60\%$

B. Varying Operating Condition

The effect of ambient conditions on the thermodynamic performance of the plant was done by varying the ambient air temperature and relative humidity from zero to 50 °C and from zero to 100% respectively. Figs. 7 and 8 show the variation of power output, energy efficiency, pressure ratio and air and fuel mass flow-rates (as a ratio of design value) with ambient air temperature and relative humidity. From the figures, it is observed that ambient temperature has significant effect on GT plant performance than relative humidity. When the GT

operates at varying ambient temperatures, the power output, energy efficiency, pressure ratio and air and fuel flow-rates are higher at lower ambient temperature than at a higher ambient temperature as shown in Fig. 7, which agrees with the manufacturer data [17].

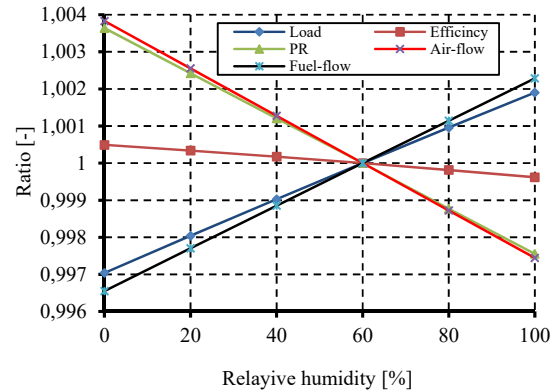

Fig. 8 Sarir GT performance vs. ambient relative humidity, at 15 °C

The increase in the ambient relative-humidity would reduce the air mass flow rate to gas cycle [5]. Because, the atomic mass of the H_2O is less than N_2 and O_2 . Due to that reason, mass of humid-air is less than the mass of the dry air for the same volume. Therefore, humid-air has less density than dry air. As a result of low density air, the amount of humid-air mass flow-rate entering into the compressor of gas cycle reduces [5]. Hence the pressure and temperature of air at compressor outlet reduced (at fixed ambient temperature). This in turn will tend to increase the fuel mass flow-rate to heat the dry air-vapor mixture up to the desired turbine inlet temperature. Therefore, the decrease in turbine power is less than the decrease in compressor power due to more flow-rate (since the more fuel injected in the CC) entering the turbine than that entering the compressor. Thus, with the increase in the RH as shown in Fig. 8 the net power output increases and energy efficiency decreases as more fuel has to be combusted.

The effects of the relative humidity on net power output of the GT unit are presented in Fig. 9. In this figure, no effect is noticed for lower ambient temperatures, while at higher ambient temperatures (greater than 313 K), the increase in relative humidity increases the net power output values. This is expected since the decrease in turbine power is less than the decrease in compressor power. This in turn will tend to increase the net power output of the GT cycle. The decrease in the compressor and turbine powers is attributed to the decrease in the air mass flow-rate (as explained at Figs. 7 and 8). At ambient temperature of 323 K, the results reveal a 10 MW increase in the net power output of the plant for a 100% increase in the relative humidity. Moreover, at 60% relative humidity, the net power output decreases from 315 MW to 230 MW as ambient temperature increases from 0 to 50 °C.

The variation of the exergy destruction ratio and efficiency of the compressor is indicated in Figs. 10 and 11. From the figures, it is observed that exergy destruction ratio and efficiency decreases slightly with an increase in RH at higher

ambient temperature values (greater than 283 K). Whereas, the exergy destruction ratio increases while the exergy efficiency decreases with an increase in the ambient temperature.

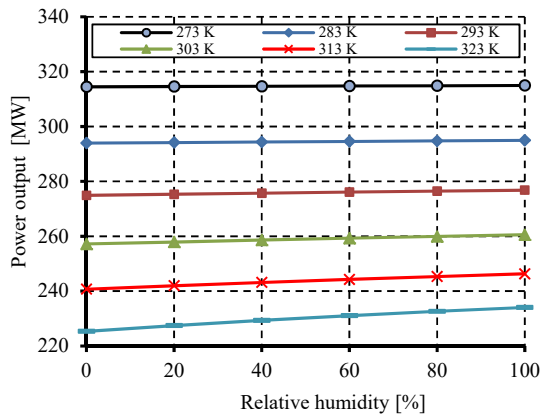

Fig. 9 Net power output with various ambient temperatures and relative humidity at 100% load

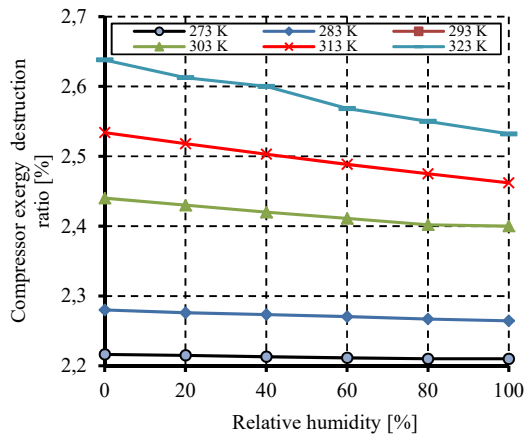

Fig. 10 The variation of exergy destruction ratio in the AC with various ambient temperatures and relative humidity, at 100% load

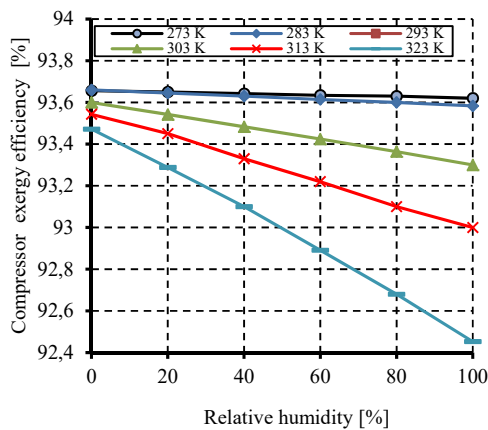

Fig. 11 The variation of exergy efficiency of the compressor with various ambient temperatures and relative humidity, at 100% load

Figs. 12 and 13 show the exergy destruction ratio and efficiency of the turbine at various ambient temperatures and relative humidity.

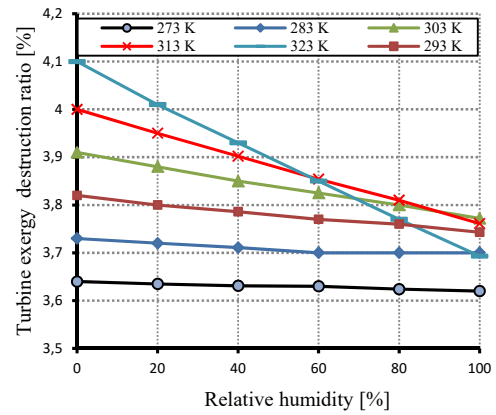

Fig. 12 The variation of exergy destruction ratio in the turbine with various ambient temperatures and RH, at 100% load

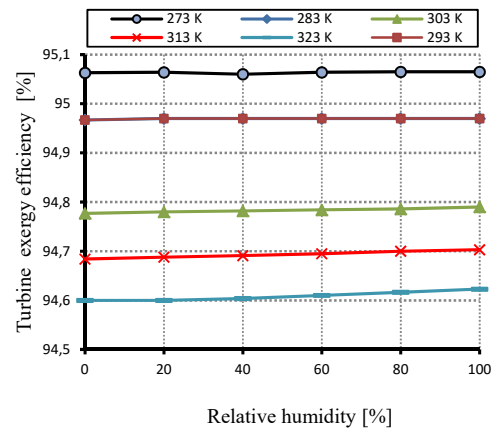

Fig. 13 The variation of exergy inefficiency of the turbine with various ambient temperatures and RH and at 100% load

The increase of ambient temperature increases the exergy destruction ratio at lower RH values (less than 60%) and decreases the exergy efficiency at all RH values. The increase in RH decreases substantially the exergy destruction ratio at higher ambient temperatures (greater than 283 K) while the exergy efficiency of turbine has no significant change as ambient RH increases (Fig. 13). The decrease in the exergy destruction ratio of the compressor and turbine is associated with the exergy destruction rate, which is proportional to the flow rate that is reduced by the increase in the ambient temperature and relative humidity [5], [9].

The exergy destruction ratio increases while exergy efficiency decreases substantially in the combustion chamber with the increase in ambient temperature and relative humidity as indicated in Figs.14 and 15 respectively.

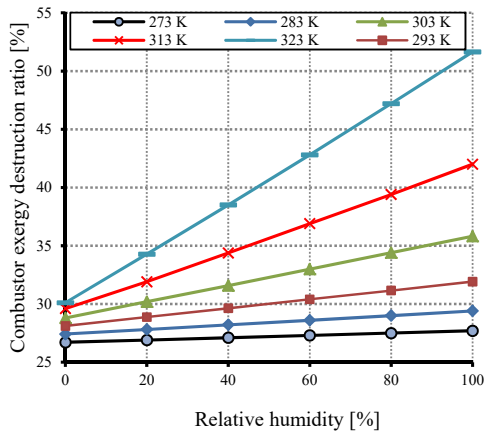

Fig. 14 The variation of exergy destruction ratio in the combustor with various ambient temperatures and relative humidities and at 100% load

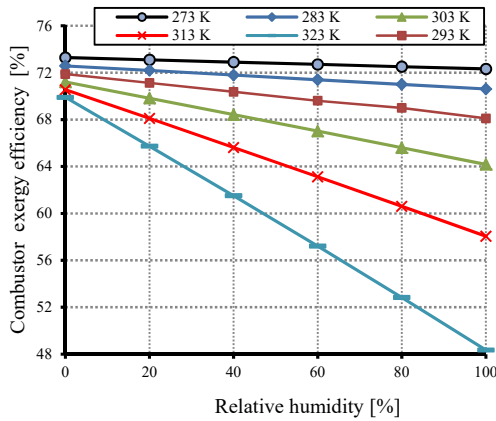

Fig. 15 The variation of exergy efficiency of the combustor with various ambient temperatures and RH and at 100% load

At higher ambient temperature greater than 283 K, as the relative humidity increases the exergy destruction ratio in the combustion chamber increases significantly. The exergy destruction ratio in the combustion chamber increases with the increase of ambient temperature and relative humidity because of deviation of air-fuel ratio from its design value. As it is shown by Figs. 7 and 8, a lower ambient temperature and relative humidity leads to higher-pressure ratio which results in less fuel supply per kilogram of air (less air-fuel ratio) to the GT cycle. However, the mass of fuel supply has a significant impact on the total exergy of fuel when varied. The exergy destruction ratio varies in the range of 25% to 53% of the total plant exergy destruction ratio corresponding to the lowest and highest ambient temperature and relative humidity, respectively.

The effects of the relative humidity on the total exergy destruction ratio and efficiency of the plant at various ambient temperatures are presented in Figs. 16 and 17 respectively. In both figures no significant effect is noticed for RH increase, while the increase in ambient temperature increases substantially the total exergy destruction ratio and decreases the total exergy efficiency. The total exergy destruction ratio

increases from 62% to 65.0% and exergy efficiency decreases from 38% to 35% as the ambient temperature increases from zero to 50 °C. It is observed that a degree (1 °C) increase in ambient temperature leads to a corresponding increase of 0.1% in the total exergy destruction ratio and 0.2% decrease in the total exergy efficiency of the plant.

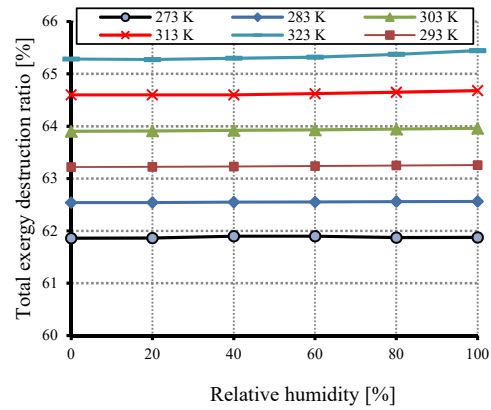

Fig. 16 Total exergy destruction ratio with various ambient temperatures and relative humidity and at 100% load

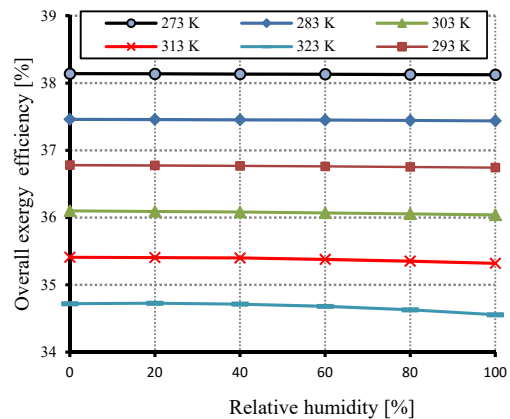

Fig. 17 Overall exergy efficiency with various ambient temperatures and relative humidities and at 100% load

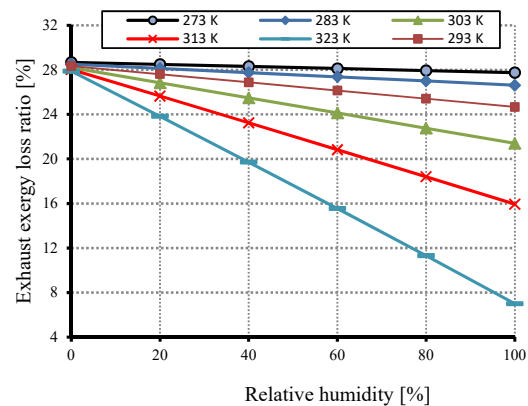

Fig. 18 Exhaust exergy loss ratio with various ambient temperatures and relative humidities and at 100% load

Fig. 18 shows the exergy loss ratio with respect to stack gas. In general, the exergy loss with the stack gas is decreasing with ambient temperature, and it is also decreasing with RH at ambient temperature greater than 283 K. The reason is the exergy destruction rate is proportional to the flow rate that is reduced by the increase in the ambient temperature and relative humidity as explained above [10], [17].

In all modes of operation, exergy destruction ratio in the combustion chamber and the exhaust gas exergy loss ratio are responsible for the major exergy losses of the GT plant. At full load, as ambient temperature increases from zero to 50 °C and RH increases from zero to 100%, the exergy destruction ratio in the combustion chamber increases from 25% to 52%. The exergy destruction ratio decreases from 4% to 3% and from 6% to 2% in the compressor and turbine respectively. The exergy loss ratio decreases from 28% to 7% in the exhaust gases.

VI. CONCLUSION

In the present study, a thermodynamic analysis has been performed to find the effect of the ambient temperature and relative humidity variations on the performance of a typical 285 MW GT unit using exergy concept. Exergy models of each GT component are formulated. They are used to compute the components and whole plant exergy destruction ratios and efficiencies for a wide range of ambient condition operation at full-load. However, with reference to the obtained results, the following conclusions have been reached:

1. The performance of GTs is greatly affected by ambient conditions, such as ambient temperature and relative humidity, but the ambient temperature has the greatest effect on GT unit power output, exergy destruction ratio and exergy efficiency.
2. The relative humidity has a negligible effect on both, the total exergy destruction ratio and efficiency at low ambient temperatures. However, decreases in exergy destruction ratio of the compressor, turbine and exhaust gas and increases in net power output and exergy destruction ratio of the combustor at higher values of ambient air temperature are noted.
3. The varying relative humidity does not have a significant effect on the compressor and turbine exergy destruction ratios, whereas it affects the exergy destruction ratio in the combustion chamber and the exhaust gas exergy loss ratio.
4. At all different ambient operating conditions, exergy destruction ratio in the combustion chamber and the exhaust gas exergy loss ratio are responsible for the major exergy losses of the GT unit.
5. When the GT plant operates at varying ambient conditions, the exergy loss at lower ambient temperature and relative humidity is less than at higher ambient temperature and relative humidity. The total plant exergy destruction ratio and exergy efficiency varies in the range of 62.05 to 65.2% and 38.2 to 34.8% respectively, corresponding to the lowest and highest ambient temperature and relative humidity.

Finally, the present study has enabled us to identify and quantify the sites having largest exergy loss in a 285 MW GT unit operating at different ambient conditions. The increase of the combustion chamber efficiency and reducing the stack gas loss should be considered to improve the efficiency of the GT cycle. An air intake cooling system with humidifier can be used in Sarir GT units to improve the condition of the compressor's air inlet. Considering all proven cooling techniques, the air chilling is particularly promising as it requires very minor configurations.

ACKNOWLEDGMENT

The author is grateful to Eng. Moftah EL-Mahdawe and Eng. Ali Amer for providing the technical and operation data and their technical advices.

REFERENCES

- [1] Electricity Company in Libya, 'Electricity Generation in Libya', Planning department, technical report, 2011.
- [2] Bolland Olav, Thermal Power Generation, Department of Engineering, Process Engineering, NTNU, 2010.
- [3] Szargut J., Morris D. R., and Steward F. R., Exergy Analysis of Thermal, Chemical and metallurgical process, Hemisphere, New York, 1988.
- [4] Gaggioli R. A. et al., "Pinpointing the Real Inefficiencies in Power Plants and Energy Systems," Proc. American Power Conference, 37, USA, 1975.
- [5] Moran M. J., and Sciubba E., "Exergy Analysis Principle and Practice", ASME J. Eng. Gas Turbines Power, vol. 116, pp. 285-290, 1994.
- [6] Balli O., Aras H. and Hepbasli A., "Exegetic Performance Evaluation of a Combined Heat and Power (CHP) System in Turkey," Int. J. Energy Research, vol. 31, no. 9, pp. 849-866, 2007.
- [7] Song T. W. et al., "Exergy Based Performance Characteristics of the Heavy Duty Gas Turbine in Part Load Operation Conditions," Exergy Int., vol.2, pp. 105-112, 2002.
- [8] Aklilu et al., "Exergy Based Performance of a Gas Turbine at Part Load Conditions," Journal of App. Sc., vol.11, no. 11, pp. 1994-1999, 2011.
- [9] Oh S. et al., "Exergy Analysis for a Turbine Cogeneration System," ASME J., Eng. Gas Turbines Power, vol. 118, pp. 782-791, 1996.
- [10] Abam F. et al., "The Effect of Ambient Temperature on Components Performance of an In-service Gas Turbine Plant using Exergy Method," Singapore J. of Scientific research vol. 1, pp. 23-37, 2011.
- [11] Tara V. et al., "Exergy Analysis of Gas Turbine Power Plant". Int. J. of Eng. Trends and Tech., vol. 4, pp. 3991-3993, 2013.
- [12] Egware H. O. and Obanor A. I., "Exergy Analysis of Omotosho Phase 1 Gas Thermal Power Plant," Int. J. of Energy power engineering, vol.295, pp.197-203, 2013.
- [13] De Sa, S., Al Zubaidy, "Gas Turbine Performance at Varying Ambient Temperature," Appl. Thermal Eng., vol. 31, pp. 2735-2739, 2011.
- [14] Fallah M. G., "Effect of Ambient Temperature on the Thermodynamic Performance of a Combined Cycle," J. of Eng. Research, Triply University, vol. 13, pp. 35-48, 2011.
- [15] Hadik A. A., "The Impact of Atmospheric Conditions on Gas Turbine Performance," Transactions of ASME, vol. 112, pp. 590-596, 1990.
- [16] Bassem G., et al., "Performance of Gas Turbine Co-generation Power Desalting Plants under Varying Operating Conditions in Kuwait," Heat Recovery Systems & CHP vol.10, no 3, pp. 243-253, 1990.
- [17] Siemens Power Generation Co., Performance Curves for Sarir SGT5-PAC 4000F Gas Turbine Power Plant Under Ambient and Loading Conditions, Siemens Performance Data Catalogue 2010.
- [18] Moran M. J., and Shapiro H. N., Fundamentals of Engineering Thermodynamics, 3rdEdn., John Wiley and Sons Inc., New York, 2006.
- [19] Katos T., The Exergy Method in Thermal plant Analysis, Butterworths, London, 1985.
- [20] Aklilu B T., Gilani S I., "Mathematical Modeling and Simulation of a Cogeneration Plant. Applied Thermal Eng. vol. 30, pp. 2545-2554, 2010.
- [21] Na Zhang, Ruixin Cai, "Analytical Solutions and Typical Characteristics of Part Load Performance of a Single Shaft Gas Turbine and its

Cogeneration,” Energy Conversion and Management, vol. 43, pp. 1323-1337, 2003.