

An Internet of Things-Based Weight Monitoring System for Honey

Zheng-Yan Ruan, Chien-Hao Wang, Hong-Jen Lin, Chien-Peng Huang, Ying-Hao Chen, En-Cheng Yang, Chwan-Lu Tseng, Joe-Air Jiang

Abstract—Bees play a vital role in pollination. This paper focuses on the weighing process of honey. Honey is usually stored at the comb in a hive. Bee farmers brush bees away from the comb and then collect honey, and the collected honey is weighed afterward. However, such a process brings strong negative influences on bees and even leads to the death of bees. This paper therefore presents an Internet of Things-based weight monitoring system which uses weight sensors to measure the weight of honey and simplifies the whole weighing procedure. To verify the system, the weight measured by the system is compared to the weight of standard weights used for calibration by employing a linear regression model. The R^2 of the regression model is 0.9788, which suggests that the weighing system is highly reliable and is able to be applied to obtain actual weight of honey. In the future, the weight data of honey can be used to find the relationship between honey production and different ecological parameters, such as bees' foraging behavior and weather conditions. It is expected that the findings can serve as critical information for honey production improvement.

Keywords—Internet of Things, weight, honey, bee.

I. INTRODUCTION

HONEYBEES are undoubtedly the most important pollinator in global agriculture [1]. Evaluating the lives of honeybees, ensuring the health of beehives, and avoiding diseases and harmful creatures might bring economic benefit to Europe that reaches millions of euros. The resolution T6-0579/2008 announced by the European Union indicate that honeybees pollinate 80% of food of human beings [2]. Plants could not be pollinated without honeybees, which might lead to the lack of grain. As a result, honeybees are essential not only for human beings but also for most plants in nature. In addition, honeybees also produce honey, propolis, bee pollen and royal jelly, which have a great medical value.

The research on the behavior of honeybees has been flourishing since the importance of honeybees is found. Nevertheless, beekeeping and honeybee related studies encounter a bottleneck when colony collapse disorder (CCD)

emerges [3]. CCD is a phenomenon associated with the decline of honeybee populations. The reason causing CCD is still unknown. However, the rapid development of IoT and WSN [4] technologies lit a glimmer of hope of figuring out the exact causes of CCD. Most studies in recent years have focused on the environment of honeybees [5]-[7]. For example, the relations between honeybee behavior and temperature and humidity in beehives, and the concentration of CO_2 and other pollution in the area have been studied.

Apart from the honeybee behavior studies, the quantity of honey is also a key index for beekeepers to evaluate a honeybee colony [8], [9]. The quantity of honey could be used to determine the health condition of a bee colony and the amount of nectar resources [12]. The period of flowering does not last long, so it is necessary for beekeepers to obtain real-time information of honey and environmental conditions that allow them to make the best decisions. In the past, beekeepers manually measured the weight of honey via the mechanical balance [10]. Recent methods that measure the quantity of honey are also complicated. Beekeepers have to take the comb away from the beehive, brushing bees away to weigh the comb. However, these methods are not able to obtain real-time information of the weight of honey. They are not efficient methods, and disturb the colony behavior and even cause the death of bees.

Considering the drawbacks mentioned, researchers have aims to develop smart beehives that monitor the behavior of honeybees while reducing the negative influence on the bee colony. In addition, smart beehives can notify beekeepers once an accident occurs. Beehives are usually placed in a wet and hot environment, and therefore the electronic components of a smart beehive have to overcome some harmful environmental conditions [2]. Besides, it is necessary to install a remote control system in beehives to make the smart beehive more useful while providing reliable information [11].

This study dedicates to developing a low-power wireless communication module that is applied to a comb weighing system, which plays an important role in precision beekeeping. The change and trend of the weight of honey could reflect the productive forces and health conditions of bee colonies [12]. An automatic weighing system is placed in the beehive. Weighing sensors are installed in the beehive to measure the weight of comb. Considering the difference of the location of the combs, weighing combs in different environments is also discussed in this study. The weight data under general conditions and extreme cases are calculated and analyzed, and the correction between the weight of honey and environmental

Z. Y. Ruan, Y. H. Chen and C. L. Tseng are with the Department of Electrical Engineering, National Taipei University of Technology, Taipei 10608, Taiwan (e-mail: qwe835481@gmail.com, sam524968@gmail.com, fl0940@ntut.edu.tw).

C. H. Wang, H. J. Lin and C. P. Huang are with the Department of Bio-Industrial Mechatronics Engineering, National Taiwan University, Taipei 10617, Taiwan (e-mail: joe970951@gmail.com, michael82118@gmail.com, allenhuang818@gmail.com).

Y. C. Yang is with the Department of Entomology, National Taiwan University, Taipei 10617, Taiwan (e-mail: ecyang@ntu.edu.tw).

J. A. Jiang is with the Department of Bio-Industrial Mechatronics Engineering, National Taiwan University, Taipei City 10617, Taiwan (e-mail: jajiang@ntu.edu.tw).

factors is examined. The results and conclusions in this study could provide beekeepers a new way to learn the conditions of the bees much sooner than before, saving time and money and bring more profits to honey production.

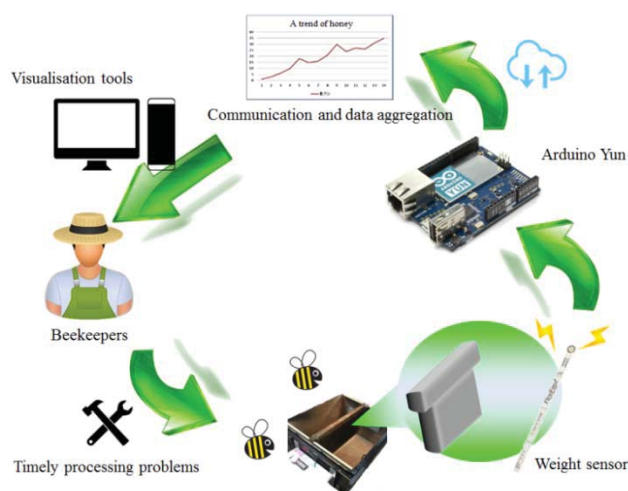

Fig. 1 Architecture of the weighing system

II. MATERIAL AND METHOD

Considering the overall cost, only two sensors, FlexiForce Sensors A201 100lb, are used by the proposed weighing system in this study. A supportive bar is used to support the combs, and the two sensors are placed under the bar. An iron bar is selected as the supportive bar, and the bar is like a rigid body so that there is no deformation in the experiment. The length, width and height of the bar is 40 cm, 1 cm, and 1 cm, respectively. The sensors measure the weight of the combs in the beehive. The raw data are collected and sent to a central processing system. The Arduino Yun is selected as the central processing system in this study. With Arduino Yun, the data can be sent to a cloud via Wi-Fi. To avoid missing data, an SD card is embedded in Arduino Yun. The data are used to analyze the conditions of colonies of honey bees. The architecture of the system is shown in Fig. 1.

A. The Sensor Used in the Weighing System

The FlexiForce Sensors A201 100lb is shown in Fig. 2, and it is a piezoelectric pressure sensor. The resistance decreases from an unlimited number to 50 kohm when the weight increases. Considering the size of a beehive, the width of the sensor is not over 1 cm. If the size of sensor is longer than the width of the supportive bar, a part of the sensor will not be pressed, which might cause a huge error. This sensor is small, thin and flexible, and the resistance of the sensor does not change even if it is twisted. The specifications of the sensor are listed in Table I. It is necessary to take the sensing range of the sensor into consideration. Each beehive at most contains eight combs. The average weight of the combs is 39.7 kgw (Bieńkowska, 2004) [13]. One sensor supports about a load of 20 kgw, the load still falls in the linear area of the sensor. The upper bound of the linear area is far from 20 kgw. Thus, the sensor is an appropriate sensor that meets the request of the

experiment. To ensure that the sensors can support the whole weight of the combs, an iron lump is used to make sure that all combs are supported by the two sensors, which means the locations of the combs will not affect the weighing result. The simple schematic diagram of the experimental settings in the beehive is shown in Fig. 3.

TABLE I
 FLEXIFORCE SENSORS A201 100LB

Length	215.9mm
Width	14mm
Thickness	0.2mm
Sensing area	9.35mm
Pressure range	0~100lb (43.3kgw)
Linearity (Error)	< ±3% (Line drawn from 0 to 50% load)
Repeatability	< ±2.5% of Full Scale (Conditioned Sensor, 80% of Full Force Applied)
Operating Temperature	-40°C ~ 60°C (-40°F ~ 140°F)



Fig. 2 FlexiForce Sensors A201 100lb

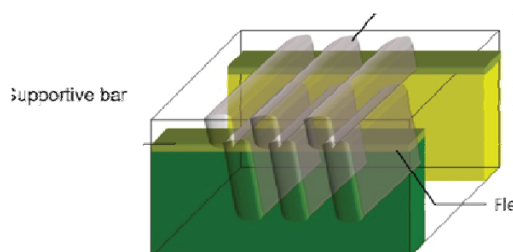

Fig. 3 The placement of the system

B. Wireless Sensor Network

The main purpose of this weighing system is to monitor the tendency of the weight of combs in long-term in the field. To satisfy this purpose, low power consumption and wireless communication is necessary. The main processor in this system is Arduino Yun, as shown in Fig. 4, which is embedded with a Wi-Fi module. With the Wi-Fi module, every sensor assembled in the beehive can transmit data in the apiary without conducting circuit configuration in advance. In order to reduce the power consumption, the system is designed to measure 2 or 3 times each day and enter a sleep mode in the rest of time. It operates at 5V and 40mA. The system circuit diagram is shown in Fig. 5.



Fig. 4 Arduino Yun used in the experiment as the main processor

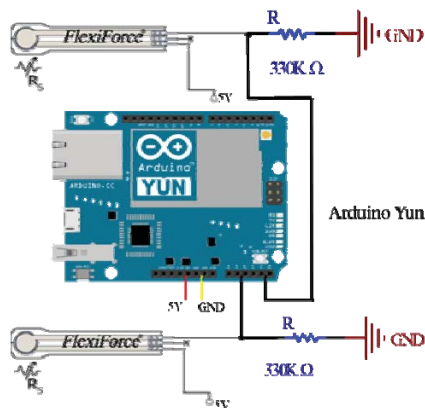

Fig. 5 The main circuit of the system

C. Experiment Method

To verify the feasibility of the system, this study conducted three experiments, including the combs being evenly placed in the beehive (regular case), concentrating on one side of the beehive (extreme case) and monitored in a long period of time (long-term monitoring). Different beekeepers may have different ways to place combs in a beehive, so it is necessary to place the combs in different locations in the experiments. Moreover, long-term monitoring is a way to test the stability of the system. In the long-term experiment, days and loads are changed to compare the weight of the combs to see if the deviation appears in certain days.

D. Regular Case

In the regular case experiment, combs are evenly placed on the supportive bars. In this experiment, the beehive contains four combs. The placement of the combs is shown in Fig. 6. The non-loading system is 2.7 kgw, and a 5 kgw standard test weight is used as the intercept in this experiment. The standard weight is placed on the combs, and a weight is added to the combs each time, so the total weight of the weight(s) is from 5 kgw to 50 kgw. To verify the measurement accuracy of the proposed system, each trial is repeated three times.

E. Extreme Case

In some cases, beekeepers prefer placing combs on the one side. Imbalance weight distribution may lead to inaccurate measurement. It is necessary to examine whether the weighing system still function normally in such a case. Like the first experiment, four combs are placed at one side of the beehive.

Similarly, the non-loading system is 2.7 kgw, and a 5 kgw standard test weight is used as the intercept. The standard weight is placed on the combs, and a weight is added to the combs each time, so the total weight of the weight(s) is from 5 kgw to 50 kgw. The placement of the combs is shown in Fig. 7. To verify the measurement accuracy of the proposed system, each trial is repeated three times.



Fig. 6 The placement of the combs in the regular case experiment



Fig. 7 The placement of combs in the extreme case

F. Long-Term Monitoring

Long-term monitoring is a direct way to verify system stability. In this experiment, the system continuously records the weight for approximately three days in order to find if any error caused by sliding or deformation of the supportive bar occurs. The experimental settings are identical to the experimental settings in the regular and extreme case. The sampling time is 10 seconds.

III. RESULTS

The adopted sensors are all calibrated before all experiments. The formula converting voltage to weight is shown in (1). The 5 kgw standard test weights are put on the sensors to establish a standard linear model. The R^2 of the linear model is 0.9788. This suggests that the weighing system performs extremely well with a high linear correlation of the voltage and the weight, and the linear model serves as the conversion formula.

$$F = V * 29.999 - 69.414 \text{ (kgw)} \quad (1)$$

where V is the voltage measured by Arduino Yun, and F is the weight obtained from the sensor.

A. Regular Case

The regular case experiment results are shown in Fig. 8, and it is found that the proposed system performs great in the regular case. The R^2 of the regression model shows great linearity between the measured and actual weight. The results indicate that the weighing system can accurately measure the weight of the combs. Moreover, compared with the actual weight, the maximum deviation occurs on 25 kgw. However, the system shows great precision on other weight levels. The results of each trial are shown in Fig. 9. The maximum standard error still occurs on 25 kgw, and the value of the error is 1.08. This means that the weight measured by the sensors might not be linear when the weight falls between 20 kgw and 30 kgw.

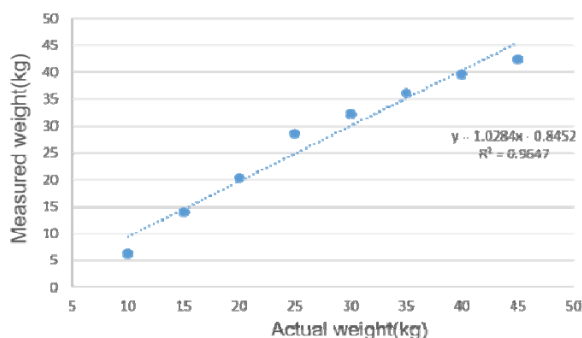

Fig. 8 Average measured weight compared with the actual weight in the regular case

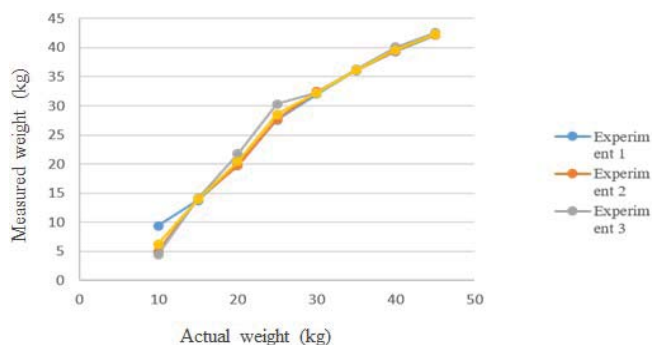

Fig. 9 Difference between the repeated trials in the regular case

B. Extreme Case

As shown in Fig. 10, the results is not quite well as those in the regular case. The R^2 of the regression model still shows a high linearity. However, the deviation is more severe. It remains linear when the load is less than 35 kgw. The deformation of the beehive is a possible explanation to the great deviations. Too much weight pressing on the wooden beehive causes deforming, and the sensors are not placed horizontally. The measured weight decreases dramatically, when the load is smaller than 15 kgw. The evenly distributed load makes the measurement of the sensors fall out of the linear area. The deviations occur because the measured weight is calculated by the average weight obtained from the sensors located at two sides of the supportive bar. If the measurement of any sensor falls out of the linear area, a server deviation will occur.

Fig. 11 shows the maximum of the standard error in the

linear area is 0.801, occurring on 25 kgw (10 kgw excluded). The performance of the proposed system in the extreme case is better than that in the regular case, and the results verify that the non-linear area occurs on 25 kgw. Although the proposed system may not perform well in a case with a strong load, the total weight would never be greater than 20 kgw in practice. Hence, the proposed system is still reliable in measuring the weight of the combs.

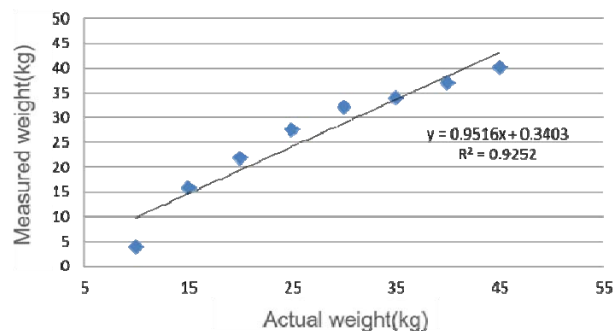

Fig. 10 Average measured weight compared with the actual weight in the regular case

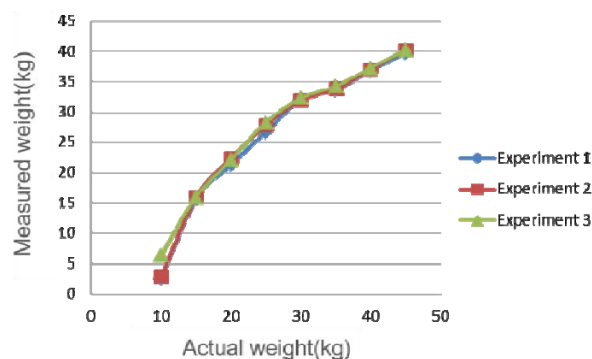

Fig. 11 Difference between the repeated trials in the regular

C. Long-Term Monitoring

The purpose of this experiment is to verify the stability of the system. The loading on the system is 35 kg and the total weight detected by the sensors is 37.7 kg. The monitoring lasts for 8 hours, and the system records every 10 seconds. Each weight is calculated by averaging 100 records. Figs. 12 and 13 show that measured weight increases in both cases. As mentioned earlier, the wooden beehive deforms under strong pressure over a long period of time. Compared to the regular case, no obvious change of the measured weight is found in the extreme case. This is because the experiment of the extreme case is done after the experiment of the regular case and the deformation of the wooden beehive has completed and the whole structure is stabilized. The experiment of the extreme case is conducted in a deformed but stabilized wooden beehive, so the change of the measured weight is less obvious than that in the experiment of the regular case.

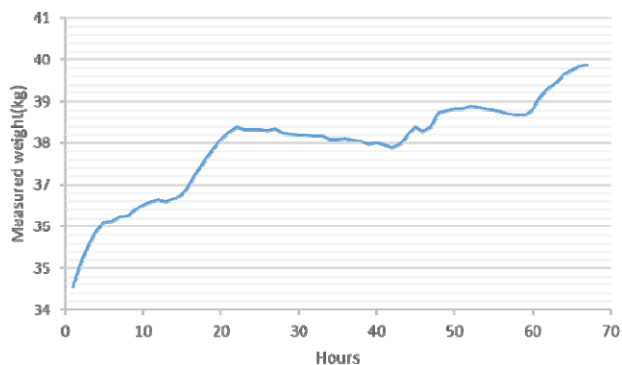

Fig. 12 Average measured weight in the regular case for long-term monitoring

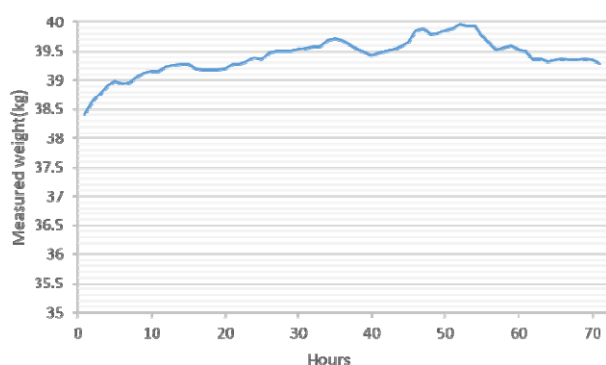

Fig.13 Average measured weight in the extreme case for long-term monitoring

IV. CONCLUSION

The proposed system can accurately measure the weight of the combs in both regular and extreme cases. However, the system needs to be improved to overcome the inaccurate readings due to the deformation of the wooden beehive. In the future, this system will undoubtedly become an indispensable part of smart beehives and smart apiculture, and the measured weight of the combs will be analyzed along with the data of temperature, humidity, foraging activities, pressure and illumination. One of the most important future studies is to install the proposed system on actual beehives in a large-scale bee farms. The data collected by the proposed system would be analyzed and provided to beekeepers via the technique of IoT and WSN. With this system, the manpower required by manually measuring the weight of honey can be reduced and the death of bees can be avoided, and smart beehives can automatically measure the weight of honey to achieve the goals of smart apiculture and smart agriculture.

REFERENCES

- [1] M. A. Aizen and L. D. Harder., "The global stock of domesticated honey bees is growing slower than agricultural demand for pollination." *Current biology* 19, no. 11, 2009, pp. 915-918.
- [2] Murphy, Fiona Edwards, et al. "Development of an heterogeneous wireless sensor network for instrumentation and analysis of beehives." *Instrumentation and Measurement Technology Conference (I2MTC)*, 2015 IEEE International. IEEE, 2015
- [3] Williams, Geoffrey R., et al. "Colony collapse disorder in context." *Bioessays* 32.10 (2010): 845-846.

- [4] Z. Shiwei and Z. Haitao, "A review of wireless sensor networks and its applications," *Automation and Logistics (ICAL)*, 2012 IEEE International Conference on, IEEE, 2012, pp. 386-389.
- [5] Porrini, Claudio, et al. "Honey bees and bee products as monitors of the environmental contamination." *Apiacta* 38.1 (2003): 63-70.
- [6] Bargańska, Żaneta, Marek Ślebioda, and Jacek Namieśnik. "Honey bees and their products: bioindicators of environmental contamination." *Critical Reviews in Environmental Science and Technology* 46.3 (2016): 235-248.
- [7] Zacepins, Aleksejs, et al. "Temperature sensor network for prediction of possible start of brood rearing by indoor wintered honey bees." *Carpathian Control Conference (ICCC)*, 2011 12th International. IEEE, 2011.
- [8] McLellan, A. R. 1977. Honeybee colony weight as an index of honey production and nectar flow: a critical evaluation. *Journal of Applied Ecology*. 14(2): 401-408.
- [9] Michels, M., R. Rojas, and T. Landgraf. 2011. A beehive monitoring system incorporating optical flow as a source of information. *Diplomsko delo*, Berlin: Freie Universität Berlin, Institut für Informatik.
- [10] J. Hambleton, *The Effect of Weather upon the Change in Weight of a Colony of Bees during the Honey Flow*, Washington D. C.: United States Department of Agriculture, 1925
- [11] Draper, Alejandro, et al. "Design and implementation of a remote monitoring system to detect contamination in beehives." *Electrical, Electronics Engineering, Information and Communication Technologies (CHILECON)*, 2015 CHILEAN Conference on. IEEE, 2015.
- [12] Fitzgerald, Darren W., et al. "Design and development of a smart weighing scale for beehive monitoring." *Signals and Systems Conference (ISSC)*, 2015 26th Irish. IEEE, 2015.
- [13] Bienkowska, M. 2004. Nationwide structure of honey flows in Poland in the years 1995-2003. *Journal of Apicultural Science*, 48(2): 111-123.