

Dynamic Analysis of Composite Doubly Curved Panels with Variable Thickness

I. Algul, G. Akgun, H. Kurtaran

Abstract—Dynamic analysis of composite doubly curved panels with variable thickness subjected to different pulse types using Generalized Differential Quadrature method (GDQ) is presented in this study. Panels with variable thickness are used in the construction of aerospace and marine industry. Giving variable thickness to panels can allow the designer to get optimum structural efficiency. For this reason, estimating the response of variable thickness panels is very important to design more reliable structures under dynamic loads. Dynamic equations for composite panels with variable thickness are obtained using virtual work principle. Partial derivatives in the equation of motion are expressed with GDQ and Newmark average acceleration scheme is used for temporal discretization. Several examples are used to highlight the effectiveness of the proposed method. Results are compared with finite element method. Effects of taper ratios, boundary conditions and loading type on the response of composite panel are investigated.

Keywords—Generalized differential quadrature method, doubly curved panels, laminated composite materials, small displacement.

I. INTRODUCTION

THE usage of fiber reinforced composite shells is highly demanded for structural applications especially in the field of aircraft structures, space stations, automobiles, ships, submarines. Composite materials have attracted significant attentions due to their specific properties such as high strength-to-weight and stiffness-to-weight ratios, corrosion resistance, longer fatigue life, stealth characteristics and most importantly tailoring of these structures for desired usage area. The anisotropic behavior and bending-stretching coupling of composite structures create difficulties for the analysis of composite shells. Therefore, understanding the behavior of these structures under different type of loading is very important to enable safe and economical designs.

Most of the studies on the literature about tapered plate and panels have been limited to static, free vibration and buckling analysis. Ganesan and Rasul [1] studied buckling analysis of tapered laminated shells considering uniaxial compression using Ritz method based on different first order shell theories. A comprehensive parametric study including boundary conditions, stacking sequence, taper configurations, radius and geometric parameters of the shells has been done in this research. Ashaur [2] applied finite strip technique in conjunction with the transition matrix to examine the vibration

of orthotropic tapered plates for different taper ratio, aspect ratio and different combinations of boundary conditions. Turvey [3] examined large deflection static analysis of thin tapered square plates with simply supported boundary conditions by using dynamic relaxation method. Javed et al. [4] carried out free vibration of anti-symmetric angle-ply composite plates with variable thickness using spline function approximation by taking parameter of material properties, ply orientation, number of lay ups, aspect ratio and coefficients of thickness variations. Bert and Malik [5] presented the free vibration analysis of rectangular tapered plates having simply supported conditions at two opposite edges and general boundary conditions at the other two edges by DQM which is firstly introduced by Bert as a tool for structural analysis. Babu et al. [6] investigated dynamic analysis of various configurations thickness tapered laminated composite plate by experimental study and validation of the developed finite element formulations. Kobayashi et al. [7] surveyed buckling problem of uniaxially compressed rectangular tapered plates by a power series method. The influences of thickness variation, plate aspect ratios, and boundary conditions on the buckling load have been taken as parameters in the survey. Civalek [8] solved free vibration problems of isotropic and orthotropic rectangular tapered plates by coupling discrete singular convolution (DSC). Torbabene et al. [9] studied natural frequencies of doubly curved shells with variable thickness taking into account various higher order Equivalent Single Layer theories using GDQ.

As it can be seen from the literature survey, there are many studies about the static, free vibration and buckling analysis of moderately thick laminated composite plates. However, there is very limited study for the dynamic behavior of laminated composite panel with variable thickness in the literature. The purpose of this study is to examine the dynamic analysis of composite doubly curved panels with variable thickness subjected to different pulse types using GDQ. Numerical results are presented to understand the behavior of the panels by changing taper ratios, boundary conditions and loading type and are compared with the commercial finite element program ANSYS. Virtual work principle is used to derive the governing differential equations. Partial derivatives in the equation of motion are expressed with Lagrange polynomials and time integration is carried out using Newmark average acceleration

I. Algul and G. Akgun are with the Department of Mechanical Engineering, Gebze Technical University, Gebze, Kocaeli, Turkey (e-mail: ilkees@gtu.edu.tr, agokce@gtu.edu.tr).

H. Kurtaran is with the Department of Mechanical Engineering, Gebze Technical University, Gebze, Kocaeli, Turkey (e-mail: hasan@gtu.edu.tr).

method for dynamic analysis. First-order shear deformation theory in association with an extension of linear strain-displacement relationships is used to consider the transverse shear effect through thickness direction.

II. STATEMENT OF THE PROBLEM

A doubly curved composite panel composed of orthotropic layers with varying thickness $h(x)$, length a and width b is given in Fig. 1. The x , y and z stated the orthogonal curvilinear coordinate system attached to the middle surface of the shell ($z=0$). R_x and R_y are denoted the principal radius of the middle surface of the panel curvature. $h(x)$ indicates thickness function varying through the x direction and is linearly expressed as shown in (1):

$$h(x) = h_0 \cdot (1 + \beta \frac{x}{a}) \quad (1)$$

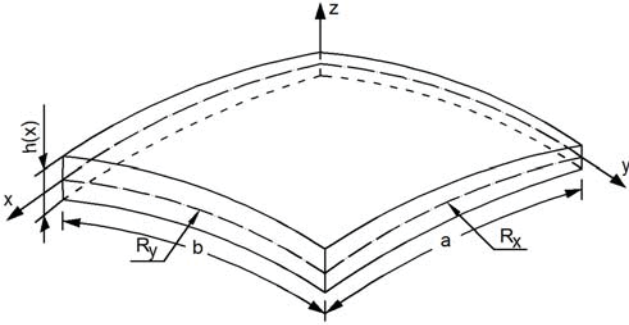

Fig. 1 Doubly curved panel with varying thickness

The displacement field at general point (x , y and z) of the panel at t time based on first-order shear deformation theory may be written as:

$$\begin{aligned} u(x, y, z, t) &= u_0(x, y, t) + z \cdot \theta_x(x, y, t) \\ v(x, y, z, t) &= v_0(x, y, t) + z \cdot \theta_y(x, y, t) \\ w(x, y, z, t) &= w_0(x, y, t) \end{aligned} \quad (2)$$

where u_0 , v_0 , w_0 are the displacement field of a point on the middle surface of the shell along the x , y and z axes, respectively. θ_x and θ_y are the rotations around the y and x axes, respectively and come from the rotations of the shell.

The strain-displacement relations for the doubly curved panels using the displacement fields in (2) from the theory of elasticity in curvilinear coordinates are given below [10]:

$$\begin{aligned} \varepsilon_x &= \frac{\partial u_0}{\partial x} + z \frac{\partial \theta_x}{\partial x} + \frac{w_0}{R_x}, \\ \varepsilon_y &= \frac{\partial v_0}{\partial y} + z \frac{\partial \theta_y}{\partial y} + \frac{w_0}{R_y}, \\ \gamma_{xy} &= \frac{\partial v_0}{\partial x} + \frac{\partial u_0}{\partial y} + z \frac{\partial \theta_x}{\partial y} + z \frac{\partial \theta_y}{\partial x} + \frac{1}{2} \left(\frac{1}{R_y} - \frac{1}{R_x} \right) \left(\frac{\partial v_0}{\partial x} - \frac{\partial u_0}{\partial y} \right), \\ \gamma_{yz} &= \theta_y + \frac{\partial w_0}{\partial y} - \frac{v_0}{R_y}, \\ \gamma_{xz} &= \theta_x + \frac{\partial w_0}{\partial x} - \frac{u_0}{R_x}. \end{aligned} \quad (3)$$

Virtual work principle to obtain the dynamic equilibrium

equations of tapered panel in curvilinear coordinate system is written as:

$$\delta U + \delta T - \delta W = 0 \quad (4)$$

δU , δT and δW specify respectively the virtual potential work of internal forces caused by internal stress, the virtual work done by the inertia forces caused by accelerations and the work done by the distributed load. The governing equilibrium equations are obtained as:

$$\begin{aligned} \frac{\partial N_x}{\partial x} + \frac{\partial N_{xy}}{\partial y} + \frac{Q_{xz}}{R_x} - \frac{\partial}{\partial y} \left(M_{xy} \cdot \frac{1}{2} \left(\frac{1}{R_y} - \frac{1}{R_x} \right) \right) &= I_0 \frac{\partial^2 u_0}{\partial t^2} + I_1 \frac{\partial^2 \theta_x}{\partial t^2}, \\ \frac{\partial N_y}{\partial y} + \frac{\partial N_{xy}}{\partial x} + \frac{Q_{yz}}{R_y} + \frac{\partial}{\partial x} \left(M_{xy} \cdot \frac{1}{2} \left(\frac{1}{R_y} - \frac{1}{R_x} \right) \right) &= I_0 \frac{\partial^2 v_0}{\partial t^2} + I_1 \frac{\partial^2 \theta_y}{\partial t^2}, \\ -\frac{N_x}{R_x} - \frac{N_y}{R_y} + \frac{\partial Q_{yz}}{\partial y} + \frac{\partial Q_{xz}}{\partial x} &= I_0 \frac{\partial^2 w_0}{\partial t^2} + q_w, \\ \frac{\partial M_x}{\partial x} + \frac{\partial M_{xy}}{\partial y} - Q_{xz} &= I_1 \frac{\partial^2 u_0}{\partial t^2} + I_2 \frac{\partial^2 \theta_x}{\partial t^2}, \\ \frac{\partial M_y}{\partial y} + \frac{\partial M_{xy}}{\partial x} - Q_{yz} &= I_1 \frac{\partial^2 v_0}{\partial t^2} + I_2 \frac{\partial^2 \theta_y}{\partial t^2}. \end{aligned} \quad (5)$$

where, N_x , N_y , N_{xy} are the in-plane force resultants, M_x , M_y , M_{xy} are the in-plane moment resultants and Q_{xy} , Q_{yz} are the transverse shear resultants, I_0 , I_1 , I_2 are the mass moments of inertia and can be calculated as:

$$\begin{aligned} (N_x, N_y, N_{xy}) &= \sum_{k=1}^n \int_{z_{k-1}(x)}^{z_k(x)} (\sigma_x, \sigma_y, \sigma_{xy}) dz \\ (M_x, M_y, M_{xy}) &= \sum_{k=1}^n \int_{z_{k-1}(x)}^{z_k(x)} (\sigma_x, \sigma_y, \sigma_{xy}) z dz \\ (Q_{yz}, Q_{xz}) &= \sum_{k=1}^n \int_{z_{k-1}(x)}^{z_k(x)} k_s \cdot (\tau_{yz}, \tau_{xz}) dz \\ (I_0, I_1, I_2) &= \sum_{k=1}^n \int_{z_{k-1}}^{z_k} \rho^k \cdot (1, z, z^2) dz. \end{aligned} \quad (6)$$

The governing differential equations in (5) are written in terms of displacement and rotations. Equation of motion for doubly curved panel can be shortly written in matrix form as

$$M\ddot{U} + KU = F \quad (7)$$

where M and K denote mass and stiffness matrix respectively. \ddot{U} and U denote the acceleration and displacement vectors, respectively. Transient response can be calculated by using implicit Newmark constant average acceleration time integration scheme:

$$\begin{aligned} \ddot{U}_{n+1} &= c_0(U_{n+1} - U_n) - c_1\dot{U}_n - \ddot{U}_n \\ \dot{U}_{n+1} &= \dot{U}_n + (1 - \gamma)\Delta t \ddot{U}_n + \gamma \Delta t \ddot{U}_{n+1} \end{aligned} \quad (8)$$

Expressing (6) in terms of displacement, velocity and acceleration and substituting (8) into (6) leads to the following algebraic equation

$$[c_0 M + K]U_{n+1} = F_{n+1} + M[c_0 U_n + c_1 \dot{U}_n + \ddot{U}_n] \quad (9)$$

where $c_0=4/\Delta_t^2$, $c_1=4/\Delta_t$, $\gamma=0.5$ is chosen for constant average acceleration method. To employ the GDQ technique, the panel is divided into $n_x \times n_x$ grid points. The total number of unknown coefficients in terms of unknown displacement values is $5(n_x+1)(n_y+1)$. The number of equations written for governing equilibrium equations at internal grid points is $5(n_x-1)(n_y-1)$. The number of equations written for boundary conditions is $10(n_x+1)+10(n_y-1)$ equations. It can be seen that the total number of equations is equal to the total number of unknown coefficients. Eq. (9) is solved successively to find unknown displacement values at other time steps until final time is reached.

III. NUMERICAL RESULTS AND DISCUSSIONS

Equilibrium equations of composite doubly curved panels ($R_x = R_y = R$) of square plan-form are obtained using virtual work principle. A MATLAB code is written to solve derived equations by using GDQ. Firstly, the written code accuracy is validated with finite element and different transient numerical examples are studied to analyze the effect of boundary conditions, thickness variation ratios and loading type. For all the transient examples, each lamina has the same thickness and composite panel dimensions are: $a=b=0.24$, $h_0=0.006$ m, $R/a=10$. The stacking sequence is $[0^\circ/90^\circ/0^\circ]$. Composite material properties are: $E_1=204$ GPa, $E_2=18.5$ GPa, $G_{12}=G_{13}=G_{23}=5.59$ GPa, $\rho=2100$ kg/m³, $\nu_{12}=0.23$. Boundary condition types are prescribed as below:

a. For simply supported type:

$$\begin{aligned} x=0,a \quad u_0 = v_0 = w_0 = \theta_x = M_y \\ y=0,b \quad u_0 = v_0 = w_0 = \theta_y = M_x \end{aligned}$$

b. For clamped type:

$$\begin{aligned} x=0,a \quad u_0 = v_0 = w_0 = \theta_x = \theta_y = 0 \\ y=0,b \quad u_0 = v_0 = w_0 = \theta_x = \theta_y = 0 \end{aligned}$$

The numerical results presented for dynamic response of composite panel subjected to following different dynamic loading:

a. Uniform step load: $q(t) = Q$

b. Sine pulse: $q(t) = \begin{cases} Q \sin\left(\frac{2\pi t}{t_f}\right) & \text{for } t \leq t_f \\ 0 & \text{for } t \geq t_f \end{cases}$

c. Blast pulse: $q(t) = \begin{cases} Q \left(1 - \frac{t}{t_f}\right) & \text{for } t \leq t_f \\ 0 & \text{for } t \geq t_f \end{cases}$

In all cases, maximum pressure value $Q=10^6$ Pa, time duration $t_f=0.004$ s and time step $\Delta t=0.0004$ s are taken. For all the numerical results presented here, the displacement w , are computed at the middle of the panel and stress σ_x , are computed at the top of the composite panel ($x=0, y=b/2$). Nondimensional transverse displacement (w/h) and stress response of composite panel for thickness variation $\beta=0, 0.7, 1.2$ for both clamped and simply supported boundary conditions subjected to blast

pulse are shown in Figs. 2-5. The results for simply supported boundary conditions under blast load with GDQ are compared with the finite element results in Figs. 2 and 3 and similar results are achieved with the proposed method using 9×9 grid points. It is observed that amplitude of displacements in Figs. 2 and 4 and stresses in Figs. 3 and 5 decreases and frequency of motion increases with the increasing taper ratios for simply support and clamped boundary conditions. The displacement values of the composite panel are much higher for simply supported boundary conditions than those for clamped boundary conditions under blast load. However, stress values occurred in composite panel structures are much higher for clamped boundary conditions than those for simply supported boundary conditions under blast load due to the constraints of clamped edges. Nondimensional transverse displacements and stress responses of composite panel subjected to sinus pulse and step pulse are shown in Figs. 6-9 and Figs. 10-13, respectively for thickness variation $\beta=0, 0.7, 1.2$ with clamped and simply supported boundary conditions. It is observed that amplitude of displacements and stresses decreases and frequency of motion, as shown in Figs. 6-13, increases with the increasing taper ratios for simply support and clamped boundary conditions under sinus and step pulses. The displacement values of the composite panel are much higher for simply supported boundary conditions than those for clamped boundary conditions under sinus and step pulses like blast load. However, stress values occurred in composite panel structures are much higher for clamped boundary conditions than those for simply supported boundary conditions under sinus and step pulses due to the constraints of clamped edges as occurred under blast load.

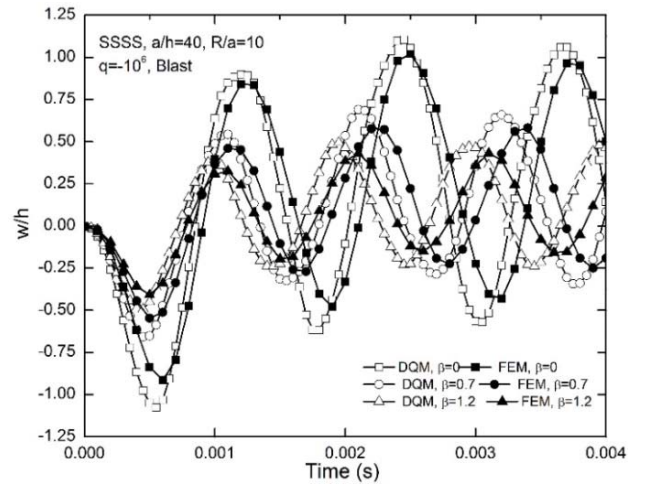

Fig. 2 Non-dimensional transverse displacement comparison of linear increasing taper ratios ($\beta = 0, 0.7, 1.2$) of simply supported composite panel under blast load with finite element method ($a/h=40, R/a=10$)

IV. CONCLUSIONS

In this study, dynamic analysis of composite doubly curved panels with variable thickness subjected to different pulse types is investigated using GDQ.

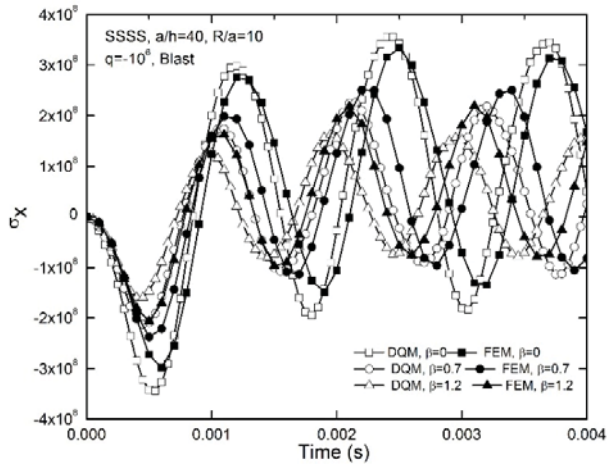

Fig. 3 Stress distribution comparison of linear increasing taper ratios ($\beta = 0, 0.7, 1.2$) of simply supported composite panel under blast load ($a/h=40, R/a=10$)

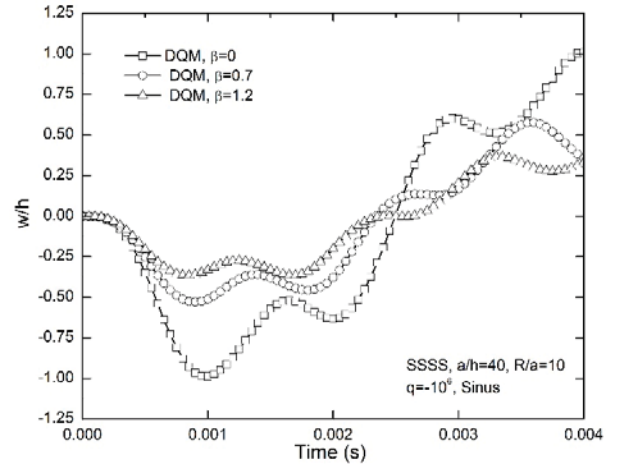

Fig. 6 Non-dimensional transverse displacement comparison of linear increasing taper ratios ($\beta = 0, 0.7, 1.2$) of simply supported composite panel under sinus load ($a/h=40, R/a=10$)

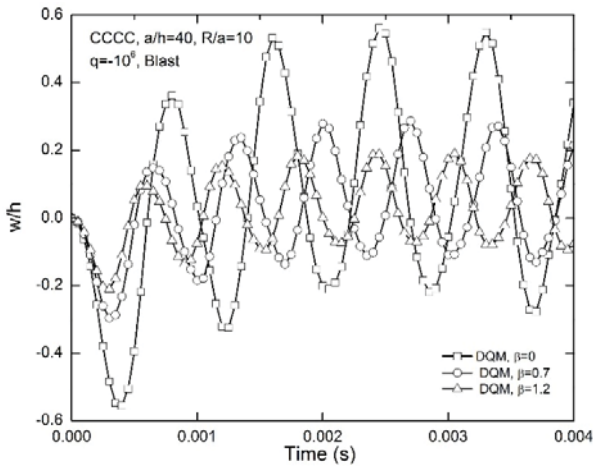

Fig. 4 Non-dimensional transverse displacement comparison of linear increasing taper ratios ($\beta = 0, 0.7, 1.2$) of clamped composite panel under blast load ($a/h=40, R/a=10$)

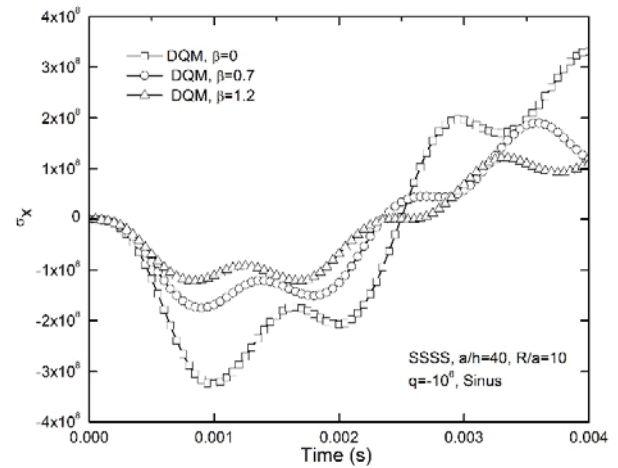

Fig. 7 Stress distribution comparison of linear increasing taper ratios ($\beta = 0, 0.7, 1.2$) of simply supported composite panel under sinus load ($a/h=40, R/a=10$)

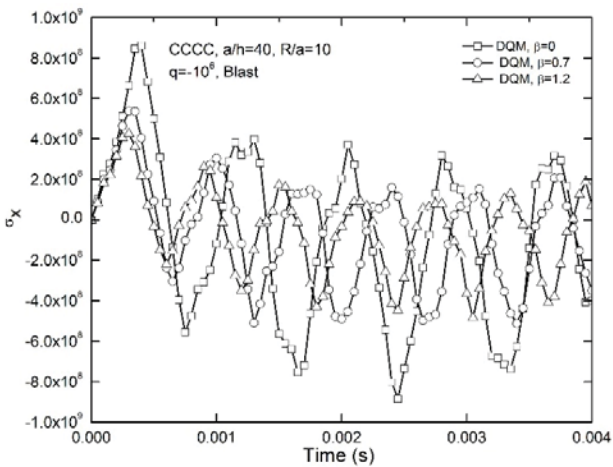

Fig. 5 Stress distribution comparison of linear increasing taper ratios ($\beta = 0, 0.7, 1.2$) of clamped composite panel under blast load ($a/h=40, R/a=10$)

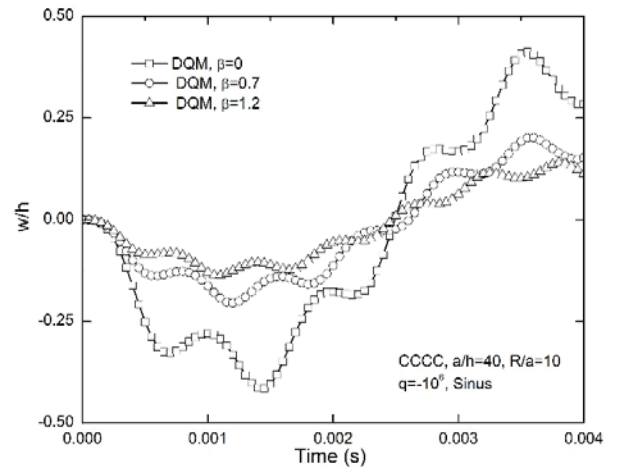

Fig. 8 Non-dimensional transverse displacement comparison of linear increasing taper ratios ($\beta = 0, 0.7, 1.2$) of clamped composite panel under sinus load ($a/h=40, R/a=10$)

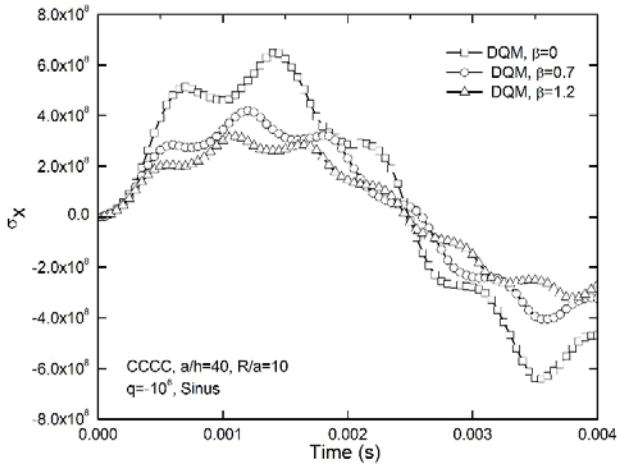

Fig. 9 Stress distribution comparison of linear increasing taper ratios ($\beta = 0, 0.7, 1.2$) of clamped composite panel under sinus load ($a/h=40, R/a=10$)

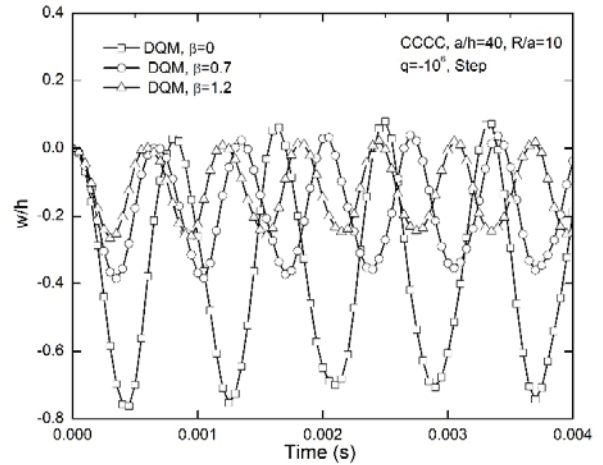

Fig. 12 Non-dimensional transverse displacement comparison of linear increasing taper ratios ($\beta = 0, 0.7, 1.2$) of clamped composite panel under step load ($a/h=40, R/a=10$)

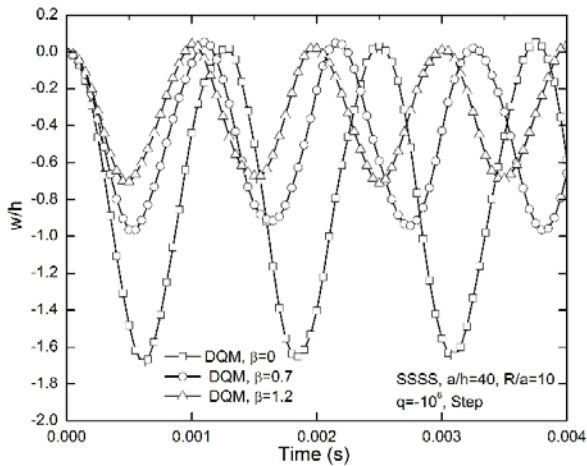

Fig. 10 Non-dimensional transverse displacement comparison of linear increasing taper ratios ($\beta = 0, 0.7, 1.2$) of simply supported composite panel under step load ($a/h=40, R/a=10$)

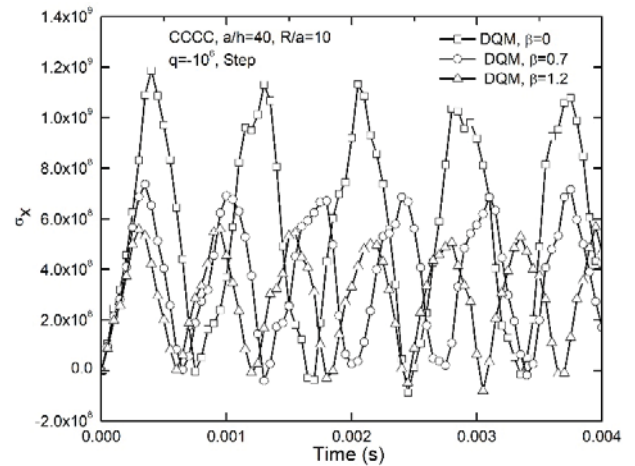

Fig. 13 Stress distribution comparison of linear increasing taper ratios ($\beta = 0, 0.7, 1.2$) of clamped composite panel under step load ($a/h=40, R/a=10$)

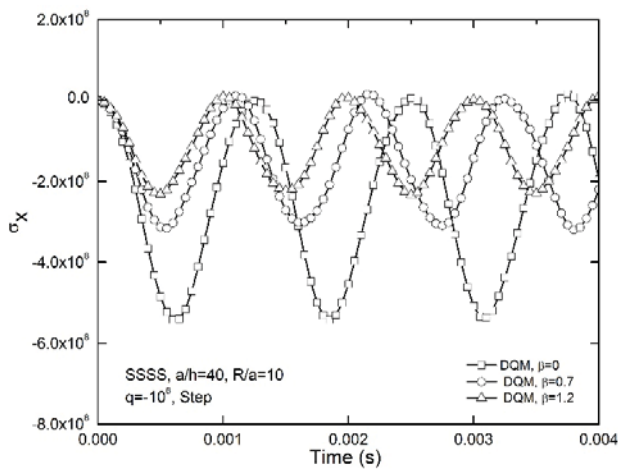

Fig. 11 Stress distribution comparison of linear increasing taper ratios ($\beta = 0, 0.7, 1.2$) of simply supported composite panel under step load ($a/h=40, R/a=10$)

The numerical results are obtained to understand the displacement and stress characters of the doubly curved panels for different boundary conditions, loading types and taper ratios and compared with ANSYS. It is seen that the numerical results with GDQ are good agreement with ANSYS. 9×9 grid points give accurate results with proposed method. The method can be applied to the efficient solution of other engineering problems and can serve as a bench work for forthcoming surveys.

It is observed that amplitude of displacements and stresses decreases and frequency of motion increases with the increasing taper ratios for all boundary conditions and load types prescribed in this study. The displacement values of the composite panel are much higher for simply supported boundary conditions than those for clamped boundary conditions under all type of load pulses prescribed in this study. However, stress values occurred in composite panel structures are much higher for clamped boundary conditions than those for simply supported boundary conditions under all type of load pulses prescribed in this study.

REFERENCES

- [1] R. Ganesan, "Compressive response of tapered composite shells," *Composite Structures*, vol. 93, pp. 2153-62, 2011.
- [2] A. S. Ashour, "A Semi - Analytical Solution of the Flexural Vibration of Orthotropic Plates of Variable Thickness," *Journal of Sound and Vibration*, vol. 240, pp. 431-45, 2001.
- [3] G. J. Turvey, "A Study of the Behavior of Square Plates at Large Deflections According to the Theories of Foepl and Von Karman," *Journal of Strain Analysis for Engineering Desig*, vol. 13, pp. 11-16, 1978.
- [4] S. Javed, K. K. Viswanahtan, Z. A. Aziz, K. Prabakar "Free vibration of anti-symmetric angle-ply plates with variable thickness," vol. 137, pp. 56-69, 2009.
- [5] C. W. Bert, M. Malik "Free Vibration Analysis of Tapered Rectangular Plates By Differential Quadrature Method-A Semi-Analytical Approach," *Journal of Sound and Vibration* vol. 190, pp. 41-63, 1996.
- [6] B. A. Ananda, S. P. Edwin, V. Rajamohan "Dynamic characterization of thickness tapered laminated composite plates," *Journal of Vibration and Control* pp. 1-21, 2015.
- [7] H. Kobayashi, K. Sonoda "Buckling of Rectangular Plates with Tapered Thickness," *Journal of Structural Engineering* vol. 116, pp. 1278-89, 1990.
- [8] Ö. Civalek "Fundamental frequency of isotropic and orthotropic rectangular plates with linearly varying thickness by discrete singular convolution method," *Applied Mathematical Modelling* vol. 33, pp. 3825-35, 2009.
- [9] F. Tornabene, F. Nicholas, B. Michele "Local GDQ Method for the Natural Frequencies of Doubly-Curved Shells with Variable Thickness: A General Formulation," *Composites Part B*, vol. 92, pp. 265-289, 2016.
- [10] J. N. Reddy "Mechanics of Laminated Composite Plates and Shells Theory and Analysis," 2nd Edition, CRC Press, 2004.