

# Realization of a Temperature Based Automatic Controlled Domestic Electric Boiling System

Shengqi Yu, Jinwei Zhao

**Abstract**—This paper presents a kind of analog circuit based temperature control system, which is mainly composed by threshold control signal circuit, synchronization signal circuit and trigger pulse circuit. Firstly, the temperature feedback signal function is realized by temperature sensor TS503F3950E. Secondly, the main control circuit forms the cycle controlled pulse signal to control the thyristor switching model. Finally two reverse paralleled thyristors regulate the output power by their switching state. In the consequence, this is a modernized and energy-saving domestic electric heating system.

**Keywords**—Time base circuit, automatic control, zero-crossing trigger, temperature control.

## I. INTRODUCTION

RECENTLY the requirements of high standard living circumstance massively make more energy exhausted. With increasing unsatisfactory environment pollution and sense of environment-friendly, energy saving becomes a main approach for mankind to solve the energy shortage before the discovery of the robust sustainable energy. In this case, energy saving technique in the boiling system should make economic factors as priority to reliably satisfy the increasingly daily demand in the market [2]. Formal heating system restrictively provides two modes:

- Full-load heating when switched on.
- Cool down with no power supply when switched off.

Whereas, this kind of system consumes a huge amount of energy, and inadequately fulfill the extra need without waiting for heating process. This thesis inventively focus on developing an auto-control energy saving technique for domestic heating supply system. The system designed in this thesis remarkably saves energy by controlling heating output power which is driven by the temperature feedback signal. In this case, the target temperature of water is able to be established by the users themselves in advance. Additionally, the auto-control function adequately matches consumers' need with both economic and enjoyable aim [4], [9]-[11].

## II. TEMPERATURE CONTROLLED HEATING SYSTEM

### A. System Parameters

The system is based on the following standard parameters: 1 Liter of tank volume, 25 Celsius of initial temperature and 1000 Watts of full-load power.

Shengqi Yu and Jinwei Zhao are with the Chongqing University, No. 174 Shazhengjie, Shapingba, Chongqing, 400044, China (e-mail: s.yu10@newcastle.ac.uk, j.zhao@newcastle.ac.uk).

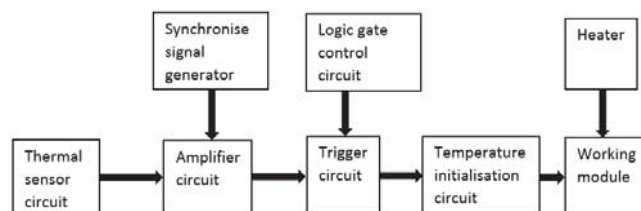

Fig. 1 System structure

### B. Main Functions

Given that the difference of water temperature is feeding back to the controller via thermal sensor when heating, the controller circuit achieves the automatic control function by controlling the input power. During the heating process, the heating power is interestingly decreased with the rise of water temperature in order to conserve power. Again, attributing to the balance between water temperature change and heating power adjustment, prolonged supply function is realized when attaining the objective default temperature [8], [12], [13].

## III. TEMPERATURE CONTROLLED HEATING SYSTEM MODELING

### A. Introduction of Sulimate Software

This thesis takes Multisim as simulation tool to simulate and analyze the operation parameters of the electric heating water temperature control system. In order to enhance the simulating and analyzing ability, Multisim provides sorts of simulation analysis functions with distinctive input methods, including the equivalent circuit input and the hardware description language input. In addition, The direct information capture and powerful simulating function remarkably contributes to the rapid, simple and efficient design and test of electric circuit [7].

### B. Construct Simulation Model

The simulation models in this thesis are designed as the electric equivalent circuit. Furthermore, the control module is zero-crossing trigger circuit based on 555 timer circuit, which contains synchronous signal generator, threshold signal circuit and trigger signal circuit. The output waves are shown as Figs. 3-5.

The operating process of synchronous signal circuit consists of several following steps:

- Firstly, the turn ratio ( $N_1:N_2=11:1$ ) of transformer

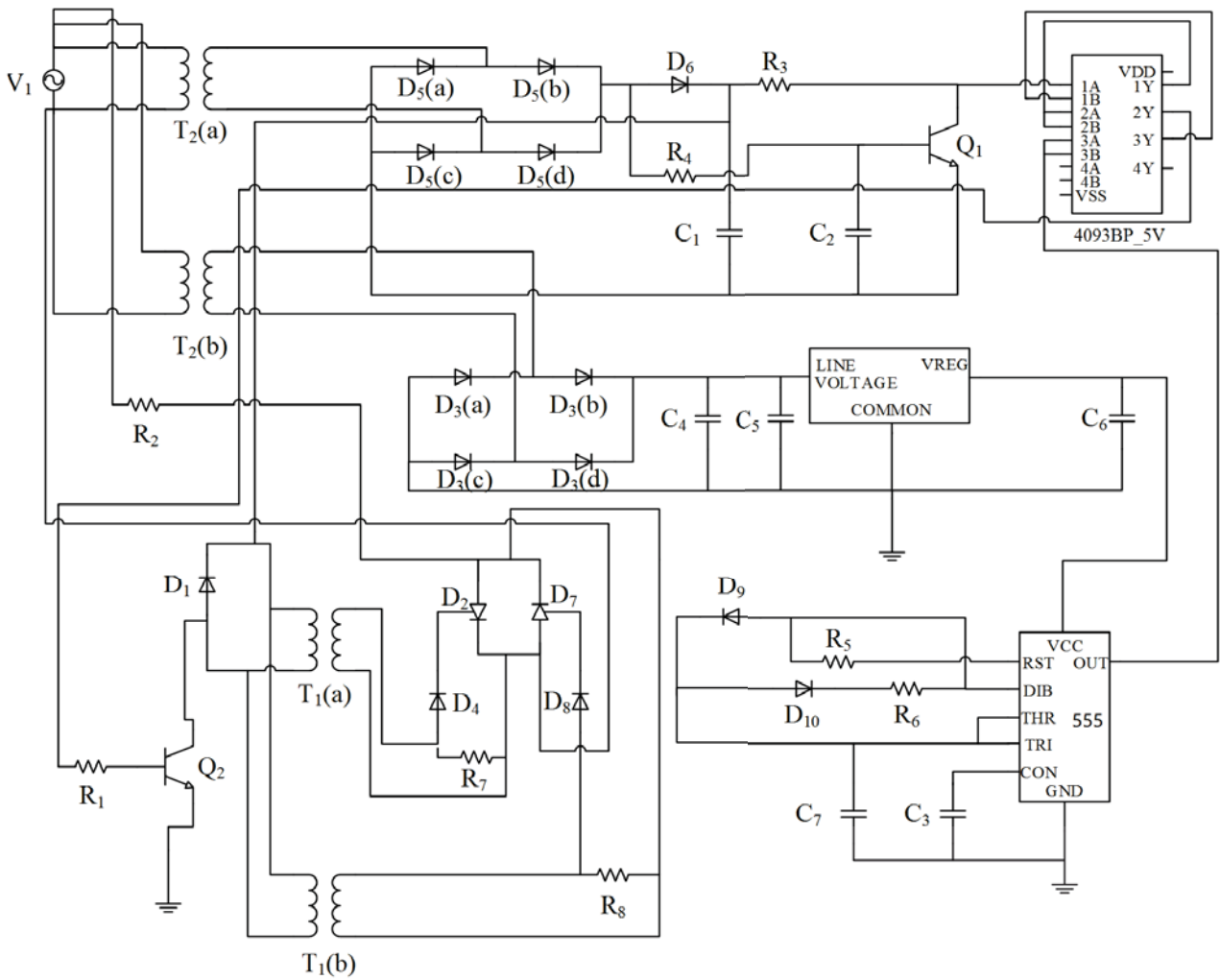

Fig. 2 Equivalent circuit of electrical temperature control system

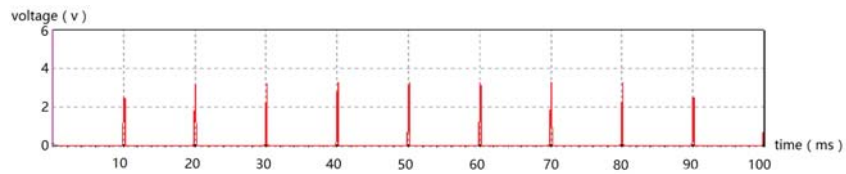

Fig. 3 Pulse signal wave

connected to voltage source produces a 20 V sine wave at the secondary side.

- Secondly, the circuit produces a positive pulse signal with 100 Hz frequency (As twice as operating frequency) after the sine wave signal passes the bridge rectifier circuit 3N259.
- Thirdly, a current signal is achieved as a result that the pulse signal leads to a current after flowing via resistor  $R_4$ , which makes the formation of base current at transistor  $Q_1$ .
- Fourthly, the emitter of  $Q_1$  outputs the zero-crossing pulse signal correspond to grid, where the signal is logic

high.

- And eventually, the resistor  $R_4$  and capacitor  $C_2$  connected to the base of  $Q_1$  can rigorously eliminate noise, selectively limit the current range and reliably set time constant. Thus, the zero-crossing signal from emitter of  $Q_1$  is obviously widened [9].

Threshold signal circuit is a multivibrator with a limited range of oscillating frequency and an adjustable pulse output width [3]. The operational process of threshold signal circuit contains two parts: Firstly, charging the capacitor  $C_7$ , the charging time is initially defined by characteristics of 555 timer. And the charging time is represented in (1),

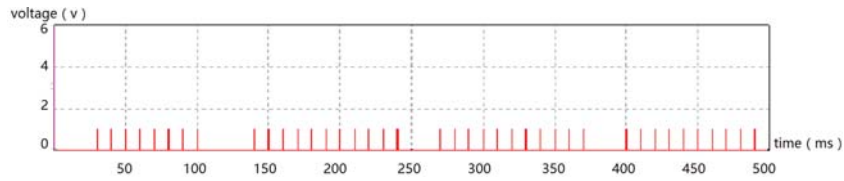

Fig. 4 Threshold pulse signal wave

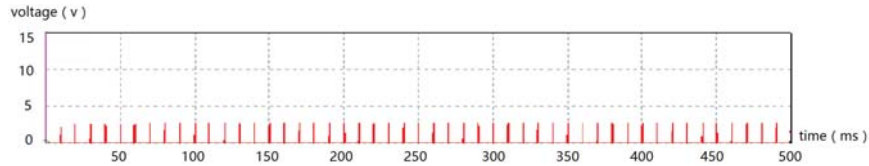

Fig. 5 Trigger pulse signal

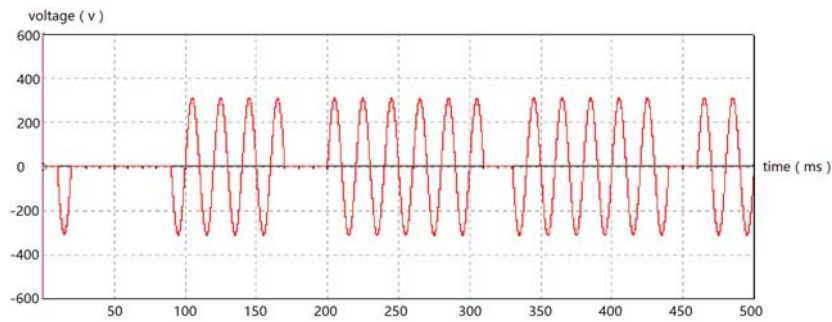

Fig. 6 Output voltage wave (a)

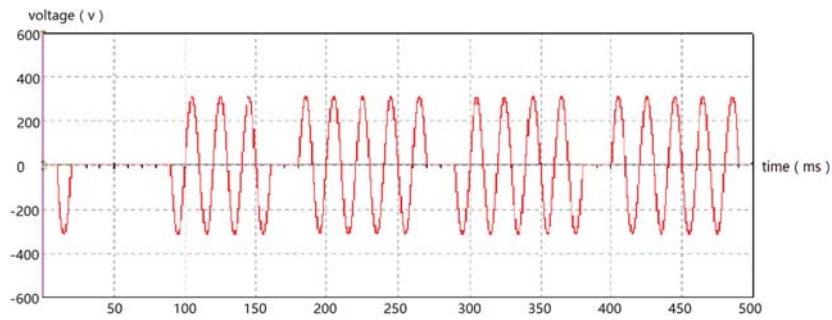

Fig. 7 Output voltage wave (b)

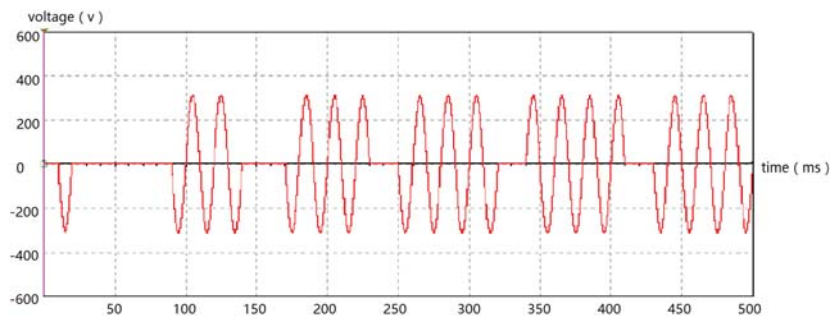

Fig. 8 Output voltage wave (c)

$$t_1 = 0.693R_5C_7 \quad (1)$$

$$t_2 = 0.693R_6C_7 \quad (2)$$

Secondly, the discharge time follows the same format, and it is illustrated in (2)

Attributing to the flexible value selection of  $R_5$  and  $C_7$ , there is no fixed period in the output signal of oscillator.

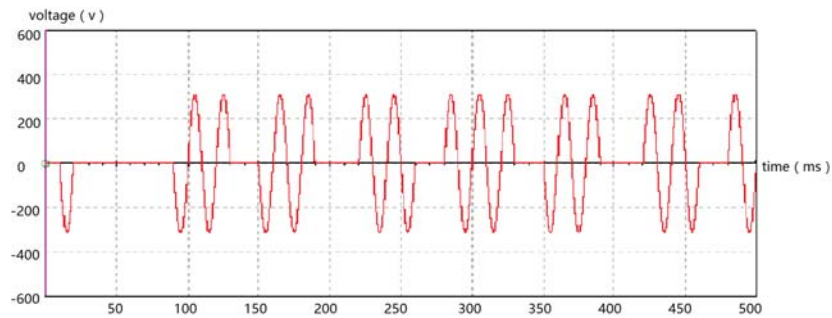

Fig. 9 Output voltage wave (d)

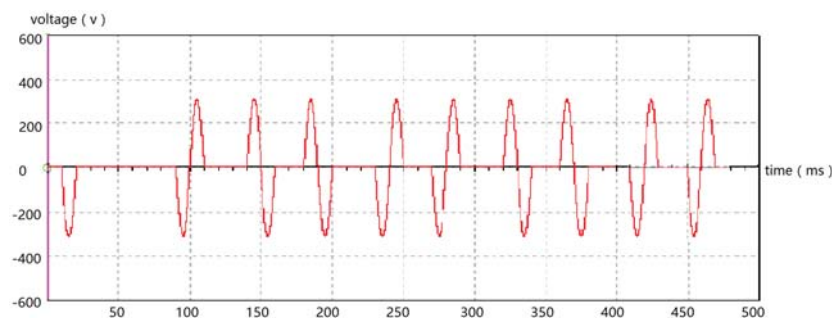

Fig. 10 Output voltage wave (e)

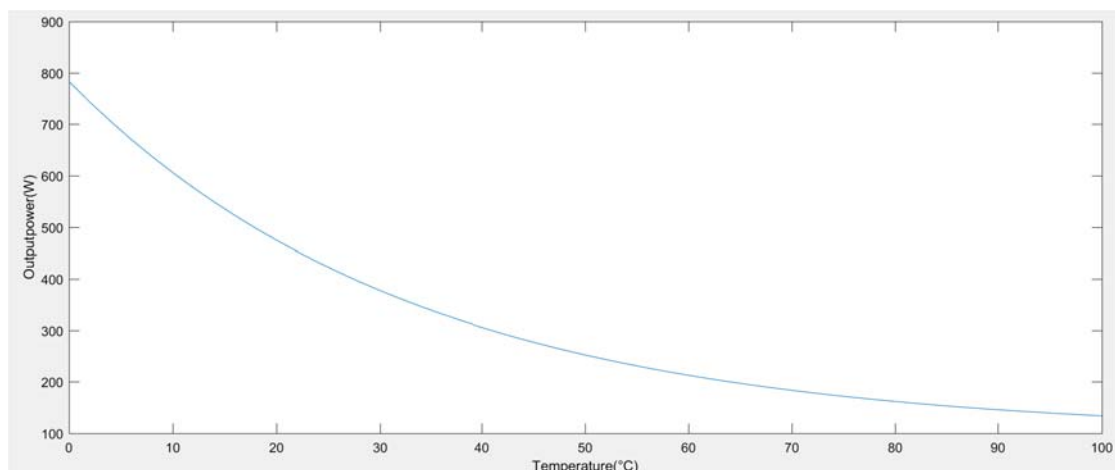

Fig. 11 Output voltage wave

But the time difference between high level and low level of the output rectangular wave is still inadequately influenced by the ratio  $t_1/t_2$ , which reflects that the threshold control signal is regulating the quantity of control pulse signal of two switch thyristors.

4093BP – 5V integrated circuit provides four levels NAND gate circuit, while only three levels are involved in this circuit. After connecting the input terminals of second level and third level, a NOT gate is formed. The first level NAND gate circuit takes the input synchronous pulse signal and reversed threshold NAND control signal into comparison [1]. To be specific, if the reversed threshold signal is at high level, the first level output must be at low level. The output signal is reversed again after passing through the second

level gate. Next, the second level output signal enters the base of amplifier  $Q_2$  and forms a pulse signal, so that the pulse signal from  $Q_2$  produces current in the primary part of transformer. And then, the secondary part receives the pulse signal induced from primary part. The circuit emits two trigger signals at the two zero-crossing point from source voltage sine wave. It must also be noted that the two trigger signal waves respectively enter the gate as well as cathode of two reversely paralleled thyristors to control the output voltage by driving the thyristors' switches [5].

### C. Simulation Analysis

The trimmer  $R_5$  is set by a range from 5 k Ohms 10 k Ohms to divide the potential. More specifically, a large

variation of resistance has a tremendously obvious effect on potential adjustment. The voltage waves on load  $R_2$  are represented from graph 6 to graph 10. These responses also present the heating power by (3)

$$P_H = V_i^2 / R_2 \quad (3)$$

Fig. 6 demonstrates the first state in the five graphs. The ratio between conductive wave number and breaking wave number is 5.5/1. During the heating process, the number conductive wave on load decreases so that there are variations of the proportions: 4.5/1, 3.5/1, 2.5/1, 1/1.5, which are shown as from Figs. 7-10. It should be significantly mentioned that the increasing temperature leads to the falling of output voltage, which also means that the output power is adequately regulated by the change of temperature. The length of high level time domain  $t_1$  can be set by changing the  $R_5$  and  $C_7$  with the appropriate value, while there is a relationship between resistance of  $R_6$  and temperature  $T$  in (4).

$$R_6 = R_0 e^{B(1/T - 1/T_0)} \quad (4)$$

It is easy to derivative (5) with the relation of  $t_1/t_2 = R_5/R_6$ .

$$t_1/t_2 = R_5/R_0 e^{B(1/T - 1/T_0)} \quad (5)$$

then  $t_2$  can be represented in (6):

$$t_2 = t_1 R_0 e^{B(1/T - 1/T_0)} / R_5 \quad (6)$$

In (6),  $t_1$  is a constant set by  $R_5$  and  $C_7$ , and so are  $R_0$  and  $B$ . It should be remarkably noted that  $t_2$  is the only variable which changed with real-time temperature. The threshold signal during  $t_2$  is reversed, and compared with synchronous pulse signal by NAND logic gate to output a control signal. In this system the power consumption  $P_2$  is 140 watts, while power of the heater  $P_1$  is 1000 watts. Moreover, the operating time of heater can be represented in (7):

$$t = t_1 + t_2 \quad (7)$$

With (1) and (2) substituted in,  $t$  can be rewritten as (8):

$$t = 0.693(R_5 + R_6)C_7 \quad (8)$$

Furthermore, the heating power  $P$  can be represented in (9):

$$P = P_1 t_2 - P_2 t \quad (9)$$

Equally significant, substitute value of  $P_1$  and  $P_2$  in and replace the time with  $R$  and  $C$ , a new expression of power is shown in (10):

$$P = 595.98R_5C_7 - 97.02R_6C_7 \quad (10)$$

Substitute (4) into (10), and (11) is acquired:

$$P = 595.98C_7R_5 - 97.02C_7R_0e^{B(1/T - 1/T_0)} \quad (11)$$

In (11),  $R_0=50$  k ohms, while  $T$  follows the thermodynamic temperature rule with a setting point of 373 K. Thus,  $R_5$  and  $C_7$  is selected manually to adjust system. The temperature during initial heating period  $T_0$  is 298.15 K, and the output power is 902 watts in this condition. When the temperature reaches the setting value, the heating power is equal to consumption power. The system maintains the water in a appropriate temperature level at the lowest cost. Fig. 11 shows the relation between output power and temperature.

During the heating process, the output power smoothly falls with the increasing temperature, which means that the automatic control function of system is reliably realized to rigorously fulfill the purpose of energy saving.

#### IV. CONCLUSION

This thesis analyzes the relation between changing temperature and relative power consumed by simulating the whole heating system. The result illustrates that the output voltage can be controlled smoothly by temperature signal variation to rigorously regulate output power. In this case, if this simple and humanized design can be involved in the domestic heating system, the daily domestic energy consumption will be tremendously saved. In addition, due to the thyristor switches and low level of operating voltage, the system is highly reliable and safe for the mankind [6].

#### APPENDIX

NAND gate A sort of logic gate, whose output depends on the input. Only when both inputs are true output the output is true, otherwise the output is false. Trigger pulse signal signal produced by logical calculating in logic calculator 4093BP-5V, with the function of driving two reverse-paralleled switch thyristors. zero-crossing pulse signal AC source voltage value changing follow the regulation of sine wave, when the voltage value reach zero a pulse signal produced, this signal synchronizes the source voltage. Synchronous pulse signal same as zero-crossing pulse signal

#### REFERENCES

- [1] Xu Xianhai. (D). Nanjing: Southeast University, 2006.
- [2] Yang, Q., Li, G. and Kang, X., 2008, July. Application of fuzzy PID control in the heating system. In 2008 Chinese Control and Decision Conference (pp. 2686-2690). IEEE.
- [3] Wang Wei. DSPPID(D). Dalian Dalian Jiaotong University, 2009.
- [4] Radakovic, Z. R., Milosevic, V. M. and Radakovic, S. B., 2002. Application of temperature fuzzy controller in an indirect resistance furnace. Applied Energy, 73(2), pp. 167-182.
- [5] Wang Yalei. LDSC(D). Xi'an: Xi'an University of Science and Technology.
- [6] Davis, J. W., Brinton, R. K. and Wiseman, R. W., 1974 Index IEEE Transactions on Industry Applications.
- [7] Xu Kui. (D). Central South University, 2014.
- [8] Bernard, J. I., 1939. The application of electric heating to domestic hot-water supply system. Electrical Engineers, Journal of the Institution of, 85(511), p. 1.
- [9] Zhao shiming, Gao feng. (J). Water & Waste Water Engineering, 2009(02).



- [10] Abdelwahed S., Abdolkhani A., Abdullah M. A., Abe S., Abe S., Abe T., Abedinpour S., Aboul-Zahab, E. M. and Aboushady, A. A., 2014. 2013 Combined Author Index IEEE Industry Applications Society Publications. IEEE Transactions on Industry Applications, 50(1), p. 643.
- [11] Forsyth S. L., 1957. Electric heating in the home. Electrical Engineering, 76(2), pp. 118-123.
- [12] Schiller P., 1951. Operational research in electricity distribution and utilization. A review of progress. Proceedings of the IEE-Part I: General, 98(112), pp.229-238.
- [13] Grierson R. and Jackson F., 1948. The authors' reply to the discussions on Engineering principles applied to the design of domestic water-heating installations of the solid-fuel/electric type. Electrical Engineers-Part II: Power Engineering, Journal of the Institution of, 95(44), pp. 201-204.