

Application of MoM-GEC Method for Electromagnetic Study of Planar Microwave Structures: Shielding Application

Ahmed Nouainia, Mohamed Hajji, Taoufik Aguilu

Abstract—In this paper, an electromagnetic analysis is presented for describing the influence of shielding in a rectangular waveguide. A hybridization based on the method of moments combined to the generalized equivalent circuit MoM-GEC is used to model the problem. This is validated by applying the MoM-GEC hybridization to investigate a diffraction structure. It consists of electromagnetic diffraction by an iris in a rectangular waveguide. Numerical results are shown and discussed and a comparison with FEM and Marcuvitz methods is achieved.

Keywords—Inductive irises, MoM-GEC, waveguide, shielding.

I. INTRODUCTION

THE discipline of EMC is concerned with the design of electronic systems while minimizing interference inside the system and between systems to the environment. Shielding is an essential part of an EMC design [1]. For evaluating interference, all the electromagnetic fields inside the shielding enclosure should be calculated by numerical simulation or by analytical formulation. In recent years, various analytical and numerical techniques have been proposed to evaluate the penetration of the electromagnetic field through apertures. The methods used for predicting the shielding of a particular enclosure and easy for designers in their investigations include transmission-line matrix [2], finite-difference time-domain (FDTD) [3], [4], finite integration technique (FIT) [5], [6], moments method [7], [8] and a hybrid moment method/FDTD approach [9] and they are applied to coupling and penetration into complex structures. Here, our work can illustrate an electromagnetic study that usually uses an Integral Equation (IE) Method combined with the Generalized Equivalent Circuit (GEC) [10]. This method is more adapted to carry out an electromagnetic study of the microwaves planar structures. Indeed, this method allows to reduce the dimension of the problem under consideration that we can write the initial boundary conditions following the integral equation form with definite on the obstacles surface when the complexity of the studied structures increases and the resolution becomes complicated. Our contribution is the application of MoM-GEC method to study the Shielding

electromagnetics. The equivalent circuits [11] introduced in the development of the Integral Equation methods are useful to transpose the field problems to equivalent circuits problems in order to simplify the associated treatment.

In this work, four possible configurations of GEC are possible to achieve the electromagnetic shielding study. Obtained results are discussed and possible interpretations are given in this work. The paper is organized as follows: We present firstly the MoM-GEC Formalism. Then, we develop an example of validation which is dedicated to study of the Shielding by an iris in waveguide. All possible versions of equivalent circuits are introduced to model this problem. Finally, the last section illustrates the numerical results and discussions.

II. MOM-GEC FORMALISM

Integral methods are more adapted to carry out an electromagnetic study of the microwaves planar structures. Since their initial boundary conditions in form of integral equations are defined on the obstacle surface, these methods permit the problem dimension reduction. The equivalent circuits introduced in the development of the Integral Equation methods are useful to transpose the field problems to equivalent circuits problems in order to simplify the associated treatment. The latest method is proposed by Marcuvitz [12] and generalized by Baudrand [10], [11] in order to solve the Maxwell's equation. This representation (GEC) is used to express the boundary conditions of the unknown electromagnetic field state with one electrical equivalent circuit. The equivalent circuit describes the studied structure as a discontinuity plane and its environment. In the discontinuity plane, we use generalized test functions that present a virtual source not storing energy. The boundary conditions that present the discontinuity environment are modeled as an impedance operator or admittance operator. The discontinuity excitation is assumed to be represented by a real field source or real current source.

A. MoM-GEC Approach Applied to Iris Structure

For validation purposes, we apply the presented MoM-GEC approach to compute the input parameters of the structure depicted in Fig. 1. Let us consider the scattering from an iris located in an infinite rectangular waveguide. The considered waveguides are infinite, lossless and symmetric through the discontinuity planes. The waveguides consist of four electric

Ahmed Nouainia is with the SysCom Laboratory, National Engineering School of Tunis and Department of Physics, Faculty of Sciences of Tunis, Tunis El Manar University B. P. 37 Le Belvedere, Tunis 1002, Tunisia (corresponding author, e-mail: ahmed.nouainia@yahoo.fr).

Mohamed Hajji and Taoufik Aguilu are with the SysCom Laboratory, National Engineering School of Tunis, Tunis El Manar University, B. P. 37 Le Belvedere, Tunis 1002, Tunisia (e-mail: hadjimed88@yahoo.fr, taoufik.aguilu@enit.rnu.tn).

walls, it is noted EEEE. The dimensions of the structures are: $a = 11.45$ mm, $b = 11.16$ mm and d is the window width, 2.5 mm. Each EEEE waveguide is associated to a modal basis f_{mn} . The considered modal basis is detailed in Appendix A. Note that the used GEC is simplified since we have taken into account the structure symmetry with regard to the discontinuity surface. There is no y dependency, so only Transverse Electric (TE) modes exist.

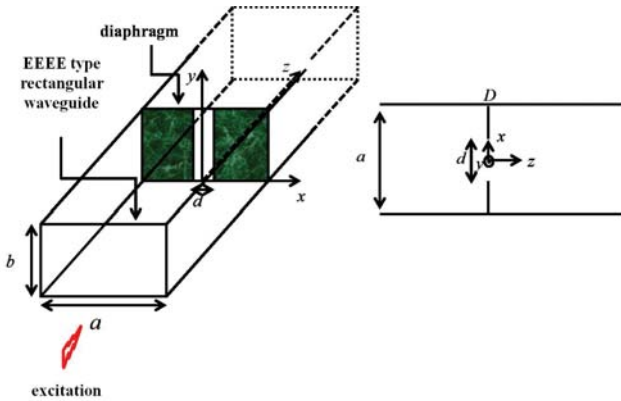

Fig. 1 Studied Structure: (a) Inductive iris enclosed by EEEE waveguide, (b) longitudinal view

Modeling with MoM-GEC method needs the presence of virtual sources, admittance or impedance operator and excitation sources. The development of this method can be summarized in various steps: Declaration of the equivalent circuit, then application of Kirchhoff and Ohm's laws to solve the electric diagram. Finally, applying Galerkin's procedure provides the final numerical form of the problem. The choice of trial functions must respect several convergence criteria of this method such as: Boundary conditions, proportionality conditions and metallic edge effect conditions. In this work, we are interested in the computation of the structure's input parameters and the influence of shielding in a rectangular waveguide. So, we need to make the various equivalent circuit configurations that are suitable to describe the presented problem. Four operational electric circuits are drawn in Fig. 2. Let $(f_m)_{m \in \{1, 2, \dots, M\}}$ be the modal basis corresponding to the EEEE waveguide and we consider the excitation modal sources in the band $]c/2a, 3c/2a[$ where $\hat{Y} = \sum_{m \gg 0}^{\infty} f_m \langle f_m | y_m \langle f_m |$, $\hat{Z} = \sum_{m \gg 0}^{\infty} f_m \langle f_m | z_m \langle f_m |$ designs respectively admittance and impedance operators describing the environment of the discontinuity. $y_m = \frac{\gamma_m}{j\omega\mu_0}$ and $z_m = \frac{j\omega\mu_0}{\gamma_m}$ designs are respectively impedance, admittance of each mode, and m is the mode number; m mode number, $\gamma_m = \sqrt{(\frac{m\pi}{a})^2 - (k_0)^2}$ denotes the propagation constant.

1. First GEC Configuration

The modeling of the considered structures is assured by the first generalized equivalent circuit illustrated in Fig. 2 (a). This version of the equivalent circuit is formed by a current excitation source, an admittance operator and a field virtual source defined in metallic regions. Its resolution follows the steps given as:

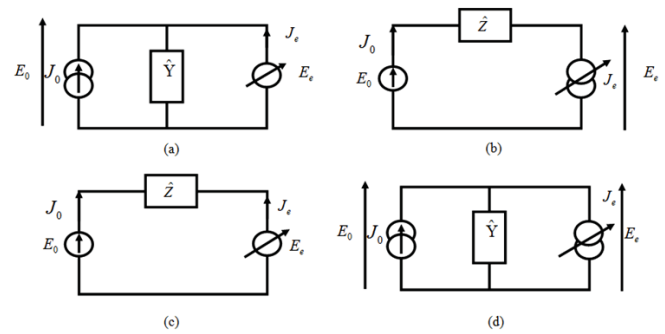

Fig. 2 Different configurations of GEC modeling the diffraction problem: (a) real current source + virtual field source, (b) real field source + virtual current source, (c) real field source + virtual field source (d) real current source + virtual current source

Application of Ohm and Kirchhoff Laws:

$$\begin{cases} E_0 = E_e & (a) \\ J_e = -J_0 + \hat{Y}E_e & (b) \end{cases} \quad (1)$$

\Downarrow

$$\begin{pmatrix} E_0 \\ J_e \end{pmatrix} = \begin{pmatrix} 0 & 1 \\ -1 & \hat{Y} \end{pmatrix} \begin{pmatrix} J_0 \\ E_e \end{pmatrix} \quad (2)$$

Galerkin Method:

$$\begin{pmatrix} V_0 \\ 0 \end{pmatrix} = \begin{pmatrix} 0 & \langle f_0 | g_p \rangle \\ -\langle g_p | f_0 \rangle & \langle g_p | \hat{Y} | g_p \rangle \end{pmatrix} \begin{pmatrix} I_0 \\ v_p \end{pmatrix} \quad (3)$$

\Downarrow

$$\begin{pmatrix} V_0 \\ 0 \end{pmatrix} = \begin{pmatrix} 0 & A \\ -A^T & B \end{pmatrix} \begin{pmatrix} I_0 \\ v_p \end{pmatrix} \quad (4)$$

where $A(1, p) = \langle f_0 | g_p \rangle$,

$$B(p, q) = \sum_{m \gg 0}^{\infty} \langle g_p | f_m \rangle y_m \langle f_m | g_q \rangle.$$

From (4), we obtain the equations system:

$$\begin{cases} V_0 = Av_p \\ 0 = -A^T I_0 + Bv_p \end{cases} \quad (5)$$

The resolutions of this system permit to calculate the input impedance.

The input impedance Z_{in} :

$$Z_{in} = \frac{1}{2}(A^T B^{-1} A) \quad (6)$$

2. Second GEC Configuration

The boundary problems in the studied structure described previously are modeled by a second equivalent circuit shown in Fig. 2 (b). Thus, this version of the equivalent circuit is formed by a field excitation source, an impedance operator and a current virtual source defined in metallic regions. Its resolution follows the steps given as

Application of Ohm and Kirchhoff Laws:

$$\begin{cases} J_0 = -J_e & (a) \\ E_e = E_0 + \hat{Z}J_e & (b) \end{cases} \quad (7)$$

\Downarrow

$$\begin{pmatrix} J_0 \\ E_e \end{pmatrix} = \begin{pmatrix} 0 & -1 \\ 1 & \hat{Z} \end{pmatrix} \begin{pmatrix} E_0 \\ J_e \end{pmatrix} \quad (8)$$

⊙ Galrekin Method:

$$\begin{pmatrix} I_0 \\ 0 \end{pmatrix} = \begin{pmatrix} 0 & -\langle f_0 | g_p \rangle \\ \langle g_p | f_0 \rangle & \langle g_p | \hat{Z} | g_p \rangle \end{pmatrix} \begin{pmatrix} V_0 \\ x_p \end{pmatrix} \quad (9)$$

⇕

$$\begin{pmatrix} I_0 \\ 0 \end{pmatrix} = \begin{pmatrix} 0 & -A \\ A^T & B \end{pmatrix} \begin{pmatrix} V_0 \\ x_p \end{pmatrix} \quad (10)$$

From (11), we obtain the equations system:

$$\begin{cases} I_0 = -Ax_p \\ 0 = A^T V_0 + Bx_p \end{cases} \quad (11)$$

⊙ The input impedance Z_{in} :

The input impedance of the iris seen from the source is, in this case, given by:

$$Z_{in} = \frac{1}{2} \frac{1}{(A^T B^{-1} A)} \quad (12)$$

3. Third GEC Configuration

The presented structure depicted in Fig. 1 can be modeled also by a third generalized equivalent circuit given by Fig. 2 (c). Thus, this version of the equivalent circuit is formed by a field excitation source, an impedance operator and a field virtual source defined in metallic regions. Its resolution follows the steps given as

⊙ Application of Ohm and Kirchhoff Laws:

$$\begin{cases} J_0 = \hat{Z}^{-1} E_0 - \hat{Z}^{-1} E_e & (a) \\ J_e = -\hat{Z}^{-1} E_0 + \hat{Z}^{-1} E_e & (b) \end{cases} \quad (13)$$

⇕

$$\begin{pmatrix} J_0 \\ J_e \end{pmatrix} = \begin{pmatrix} \hat{Z}^{-1} & -\hat{Z}^{-1} \\ -\hat{Z}^{-1} & \hat{Z}^{-1} \end{pmatrix} \begin{pmatrix} E_0 \\ E_e \end{pmatrix} \quad (14)$$

⊙ Galrekin Method:

In this case, the Galerkin method is not applicable because of the irregularity of the impedance operator. Indeed, the operator \hat{Z} does not contain the contribution of the fundamental mode TE_{10} . In this way, the modal basis that constitutes this operator is not complete and it is not invertible. Hence, the operator \hat{Z}^{-1} is not defined.

⊙ The input impedance Z_{in} :

Because of the impedance operator irregularity, the input impedance Z_{in} is not defined.

4. Fourth GEC Configuration

The boundary problem in the studied structure is modeled by a fourth operational electric circuit represented by the diagram shown in Fig. 2 (d). This version of the equivalent circuit is formed by a current excitation source, an impedance operator and a current virtual source defined in metallic regions. Its resolution follows the steps given as:

⊙ Application of Ohm and Kirchhoff Laws:

$$\begin{cases} E_0 = \hat{Y}^{-1} J_0 + \hat{Y}^{-1} J_e & (a) \\ E_e = \hat{Y}^{-1} J_0 + \hat{Y}^{-1} J_e & (b) \end{cases} \quad (15)$$

$$\begin{pmatrix} E_0 \\ E_e \end{pmatrix} = \begin{pmatrix} \hat{Y}^{-1} & \hat{Y}^{-1} \\ \hat{Y}^{-1} & \hat{Y}^{-1} \end{pmatrix} \begin{pmatrix} J_0 \\ J_e \end{pmatrix} \quad (16)$$

⊙ Galrekin Method:

In this case, the Galerkin method is not applicable because of the irregularity of the impedance operator. Indeed, the operator \hat{Y} doesn't contain the contribution of the fundamental mode TE_{10} . In this way, the modal basis that constitutes this operator is not complete and it is not invertible. Hence, the operator \hat{Y}^{-1} is not defined.

⊙ The input impedance Z_{in} :

Because of the impedance operator irregularity, the input impedance Z_{in} is not defined.

III. NUMERICAL RESULTS AND DISCUSSION

A. Convergence Study

Firstly, we start by the convergence study. Fig. 3 shows the input impedance convergence of the studied structure when using the available four GEC versions. The convergence is given as a function of number of test functions (N_e) represented by x axis. It is given also for different number of waveguide modes (M), so we observe several curves for each configuration. It is shown that for the first GEC convergence is given for about $N_e = 30$ and $M = 3000$ (Fig. 3 (a)); however, for the second GEC, the convergence is obtained for $N_e = 50$ and $M = 5000$ (Fig. 3 (b)).

B. Study of Shielding

After obtaining convergence, we draw the variation of the input impedance as a function of frequency for each suitable configuration. Fig. 4 shows the input impedance computed in each case for the frequency range [13.5-39.3 GHz].

To show the advantages of our study, we present a comparison between the GEC configurations in terms of convergence and computational time. Thus, Table I shows the number of test and modal basis functions needed to reach the convergence for each GEC configuration. The required CPU time is given by the same table. Consequently, we note that the convergence depends on the choice of excitation source. Besides, the third equivalent circuit converges faster than other models of equivalent circuits. It requires also a little processing time to achieve input impedance.

TABLE I
COMPUTATIONAL TIME CONSUMED BY DIFFERENT GEC CONFIGURATIONS TO REACH THE INPUT IMPEDANCE CONVERGENCE

Generalized equivalent	Basis functions M	Test functions N_e	CPU time
First equivalent circuit	3000	30	76.18 seconds
Second equivalent circuit	5000	50	317.18 seconds

C. Validation of Numerical Results

As results, we plot the input impedance given by different GEC configurations and we compare it with each given by HFSS software and Marcuvitz method. Firstly, we note that the third and fourth configurations associated to Figs. 2 (c) and

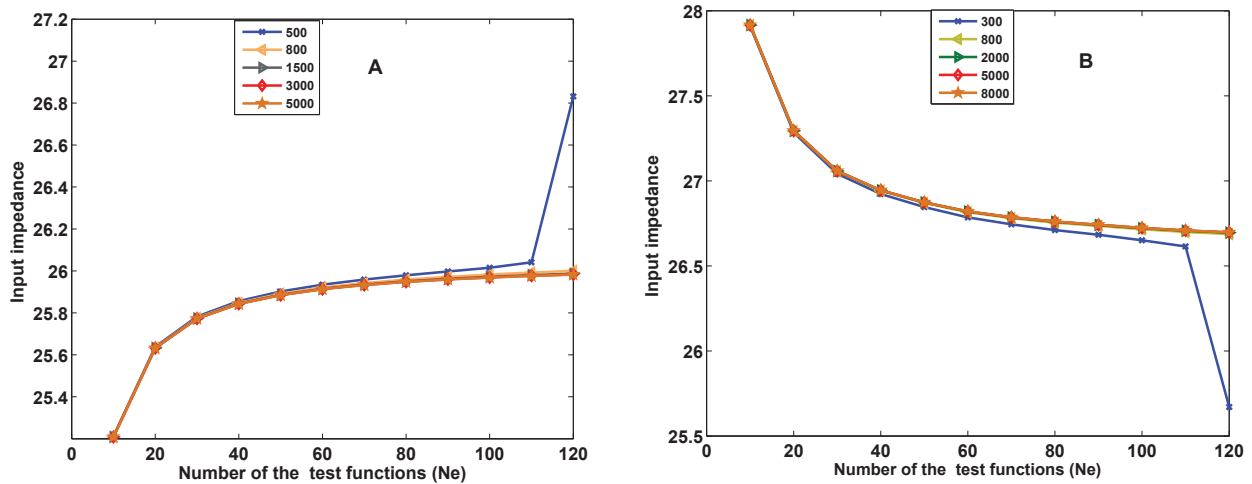

Fig. 3 Convergence study of the structure input impedance at the operating frequency $f=13.5\text{GHz}$. (A) First equivalent circuit (B) Second equivalent circuit

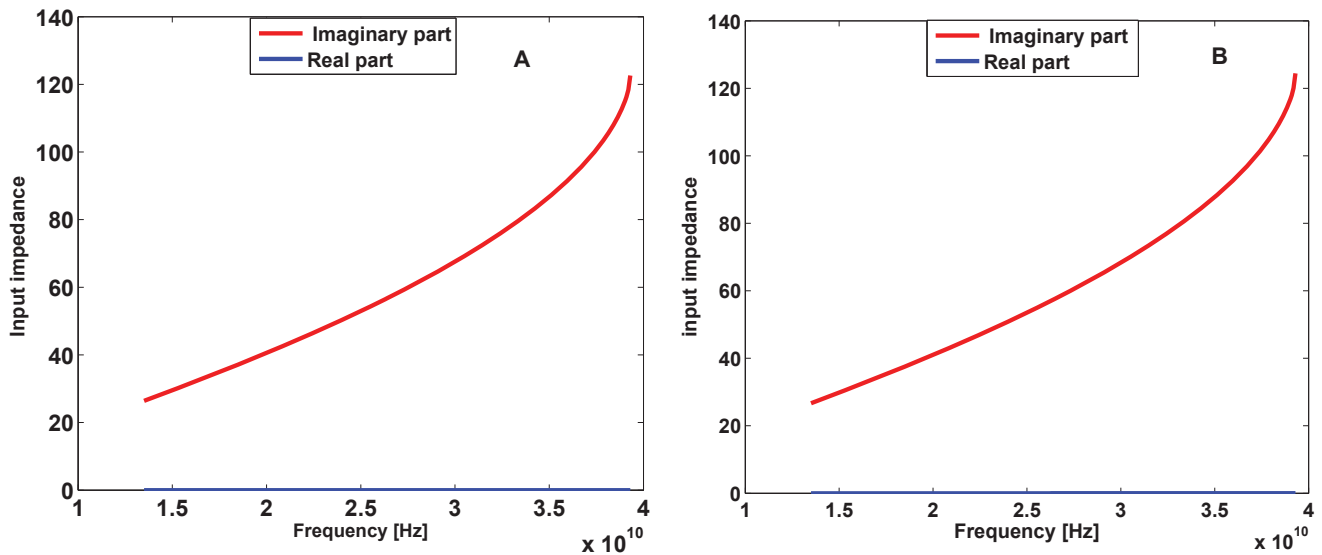

Fig. 4 Variation of input impedance against frequency: (A) First equivalent circuit (B) Second equivalent circuit

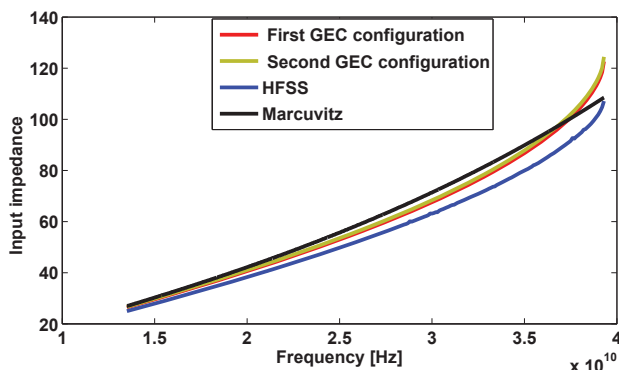

Fig. 5 Comparison of the input impedance obtained by MoM-GEC with: HFSS software and Marcuvitz method against frequency

present a singularity problem in the numerical computation due to the non-invertibility of \hat{Y} and \hat{Z} operators in these cases. However, first and second configurations show a good agreement with HFSS and they are better than Marcuvitz method that is approximative [12].

For studying the Shielding, we drew the variation of the coefficients of transmission and reflection according to the frequency. Indeed, by basing itself on previous results, we used the second operational electric circuit. In figure, we show the variation of the coefficients S_{11} and S_{21} in function of the frequency. These results are compared with those calculated by HFSS and Marcuvitz method. We note an excellent agreement between our results and those given by HFSS and Marcuvitz method. As also we have noticed through its coefficients, that the iris presents a good shielding that does not allow the penetration of electromagnetic field inside the guide.

(d) are unavailable to model the considered problem. They

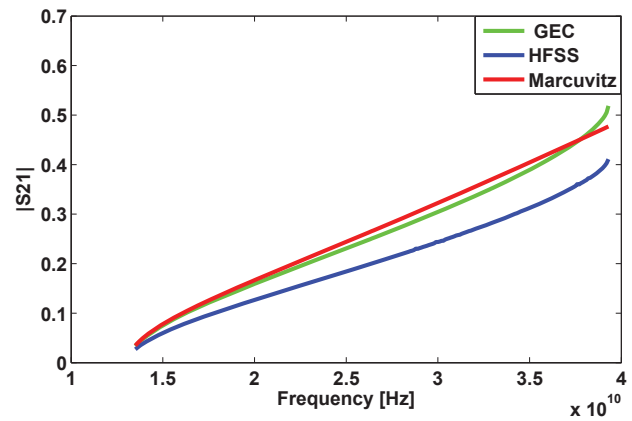
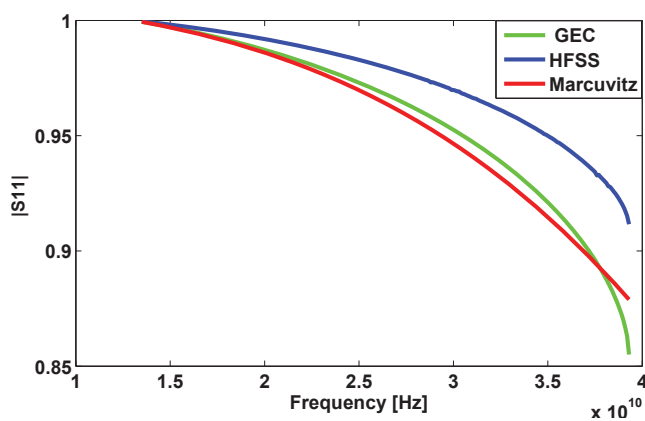

Fig. 6 Variation of parameters S11 and S21 against frequency

IV. CONCLUSION

In this paper, we present the concept of Generalized Equivalent Circuits modeling that our goal is to simplify the resolution of the electromagnetic problems by transposing the field problem to a simple circuit problem. This problem is solved numerically by applying the Galerkins procedure that is known by its simplicity formulation and general application. And we apply this method Mom-GEC for studying the shielding of a wave guide. Our obtained results are compared with other methods and we note a good agreement.

APPENDIX

The mode basis:

$$\begin{cases} TE_{10} = \begin{cases} 0 \\ -\sqrt{\frac{2}{a}} \sin\left(\frac{\pi x}{a}\right) \end{cases} \\ TE_{m0} = \begin{cases} 0 \\ -\sqrt{\frac{2}{a}} \sin\left(\frac{m\pi x}{a}\right) \end{cases} \end{cases}$$

REFERENCES

- [1] M. P. Robinson, T. M. Benson, C. Christopoulos, J. F. Dawson, M. D. Ganley, A. C. Marvin, S. J. Porter, and D. W. P. Thomas, Analytical formulation for the shielding effectiveness of enclosures with apertures, *IEEE Trans. Electromagn. Compat.*, vol. 40, no. 3, pp. 240248, Aug.1998.
- [2] R. Attari and K. Barkeshli, Application of the transmission line matrix method to the calculation of the shielding effectiveness for metallic enclosures, in *Proc. IEEEAntennas Propagation Soc. Int. Symp.*, vol. 3, Jun. 1621, 2002, pp. 302305.
- [3] Li M., Nuebel J., Drewniak J. L., Hubing T. H., Dubroff R. E., Van Doren T. P.: EMI from cavity modes of shielding enclosures FDTD modeling and measurements, *IEEE Trans. Electromagn. Compat.*, 2000, 42, (1), pp.2938.
- [4] M. Li, J. Nuebel, J. L. Drewniak, T. H. Hubing, R. E. Dubroff, and T. P. Van Doren, EMI from cavitymodes of shielding enclosures FDTD modeling and measurements, *IEEE Trans. Electromagn. Compat.*, vol.42, no. 1, pp. 2938, Feb. 2000.
- [5] Benhassine S., Pichon L., Tabbara W.: An efficient finite-element time-domain method for the analysis of the coupling between wave and shielded enclosure, *IEEE Trans. Magn.*, 2002, 38, (2), pp. 709712.
- [6] W. P. Carpes Jr., L. Pinchon, and A. Razeq, Analysis of the coupling of an incident wave with a wire inside a cavity using an FEM in frequency and time domains, *IEEE Trans. Electromagn. Compat.*, vol. 44, no. 3, pp. 470475, Aug. 2002.
- [7] Wallyn W., De Zutter D., Rogier H.: Prediction of the shielding and resonant behavior of multisection enclosures based on magnetic current modeling, *IEEE Trans. Electromagn. Compat.*, 2002, 44, (1), pp. 130138.

- [8] G. Wu, X.-G. Zhang, Z.-Q. Song, and B. Liu ,Analysis on Shielding Performance of MetallicRectangular Cascaded Enclosure with Apertures, *Progress In Electromagnetics Research Letters*, Vol. 20, 185-195, 2011.
- [9] Lotz, R., J. Ritter, and F. Arndt, 3D subgrid technique for the finite difference method in frequency domain, *IEEE-MTT-S Int. Microwave Symp. Digest*, 12751278, Baltimore, MD, June 1998.
- [10] H. Baudrand, "Introduction au Calcul des Elements de Circuits Passifs en Hyper-frquences", Editions Cepadues 2000.
- [11] D. Bajon and H. Baudrand, "Equivalent circuit representation for integral formulation of electromagnetic problems," *Int. journal of Num. Modeling*, vol. 15, pp. 23-57, jan. 2002.
- [12] N. Markwitz, "Waveguide handbook", the institution of electrical engineering, 1986.