

# A Microwave Bandstop Filter Using Defected Microstrip Structure

H. Elftouh, N. T. Amar, M. Aghoutane, M. Boussouis

**Abstract**—In this paper, two bandstop filters resonating at 5.25 GHz and 7.3 GHz using Defected Microstrip Structure (DMS) are discussed. These slots are incorporated in the feed lines of filters to perform a serious LC resonance property in certain frequency and suppress the spurious signals. Therefore, this method keeps the filter size unchanged and makes a resonance frequency that is due to the abrupt change of the current path of the filter. If the application requires elimination of this band of frequencies, additional filter elements are required, which can only be accomplished by adding this DMS element resonant at desired frequency band rejection. The filters are optimized and simulated with Computer Simulation Technology (CST) tool.

**Keywords**—Defected microstrip structure, microstrip filters, passive filter.

## I. INTRODUCTION

RECENTLY, an increasing interest has been given to the study of several periodic structures etched in microstrip lines that, at certain frequencies, prohibit wave propagation [1]. Among these structures, we distinguish for instance: Photonic Band Gap (PBG) [2], [8], Electromagnetic Band Gap (EBG) [3], [4], DMS and Defected Ground Structure (DGS). The study of PBG structures has been carried out first in optical frequencies applications. However, the use of PGB structures has been extended to microwave and millimeter-wave applications. In general, PBGs have band gap or stop band effects [2], [3], [8]. However, it is hard to find equivalent circuit and relevant parameters of PGB structures. This issue makes them difficult to use in microwave and millimeter-wave components design. As solution to this problem we use DMS and DGS structures.

In this work, we propose two DMS filters that resonate respectively at 5.25 GHz and 7.3 GHz. Its applications can be extended to passive and active devices.

## II. DMS

DMS are used to enhance the behavior of different planar passive circuit and perform a serious LC resonance property in certain frequency and suppress the spurious signals. In order to obtain a DMS filters, Fig. 1 shows several structures of DMS that can be used. They differ in occupied area and in its equivalent L-C circuit [9]. In principle, these defects disturb the surface current distribution, increase the electric length,

and the effective capacitance and inductance of a microstrip line. Accordingly, the DMS has stop band and slow-wave characteristics [5], [8].

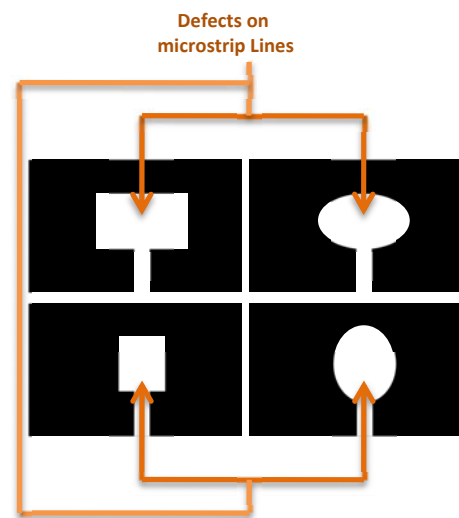

Fig. 1 Some examples of defects on Microstrip lines

When we introduce discontinuities in the path of line, the slow wave factor of a DMS microstrip line is raised, and then the impedance of line increases [10]. Thus, microwave components such as bandstop filters can be designed using these characteristics.

In this work, we have used the substrate FR4 due to its low cost and easy fabrication. The substrate thickness is  $h=1.6$  mm with a relative permittivity  $\epsilon_r=4.4$  and a tangent loss  $\delta=0.021$ .

The filters' dimensions are optimized with CST microwave studio simulation tool, as explained in the following sections.

## III. EXTRACTION OF CIRCUIT MODEL OF DMS FILTERS

The DMS filters investigated in this work consist of two bandstop filters. The first filter consists of two perpendicular slots etched on a microstrip line as shown in Fig. 2 and the second one has the same slots that are filled from their inside as shown in Fig. 3.

In Fig. 2, the parameters  $a$ ,  $b$ ,  $d$ ,  $e$  and  $l_f$  have the following values: 0.3 mm, 3 mm, 1.2 mm, 1.6 mm and 20 mm, respectively and  $s=0.4$  mm for the second filter. The strip width,  $W_f = 3$  mm, is chosen to obtain  $50\Omega$  for the characteristic impedance.

Based on EM simulation results, a circuit model of the DMS is established and the lumped elements of this model are extracted using circuit theory. The equivalent circuits of the

H. Elftouh is with the Department of Physics, Faculty of Science of Tetouan, Morocco (Corresponding author; e-mail: elftouhhaane@hotmail.fr).

N.T. Amar, M. Aghoutane, and M. Boussouis are with the Department of Physics, Faculty of Science of Tetouan, Morocco (e-mail: nai\_amar@hotmail.fr, aghoutane@gmail.com, Mohamed.boussouis@gmail.com).

first DMS filter and the second DMS filter are presented as a parallel RLC circuit for the first one and as two RLC parallel circuits for the other one as shown in Fig. 3 due to resonance phenomena [6].

The resonance effect is caused by an abrupt change of the current direction in the Microstrip line. However, as shown in Fig. 3, the parallel resistance R is included to take into consideration radiation and surface wave losses.

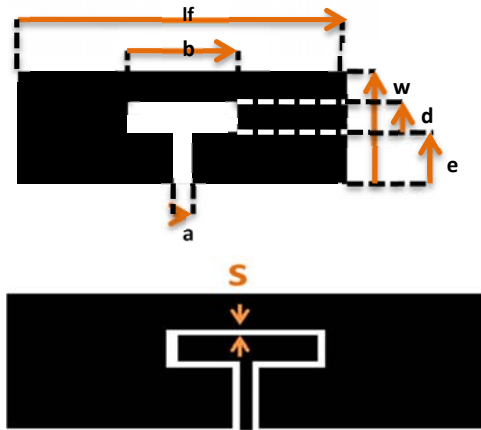

Fig. 2 The view of microstrip line with DMS shape (a) DMS filter etched from inside (b) DMS filter not etched from inside

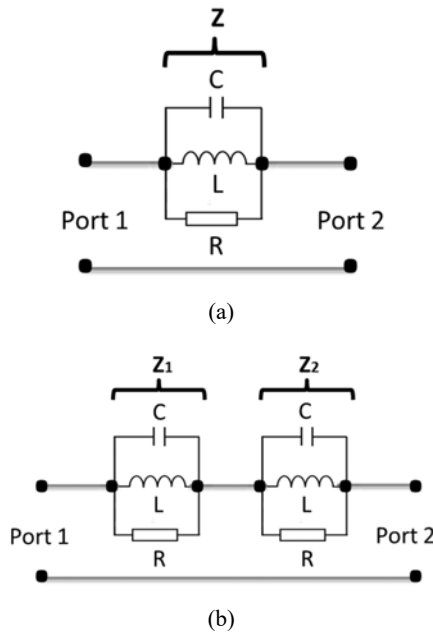

Fig. 3 Equivalent circuit of DMS cell (a) DMS filter etched from inside (b) DMS filter not etched from inside

We can use the equations below to calculate the parameters of the extracted equivalent circuit of the proposed filters [7], [8]:

$$C = \frac{fc}{200\pi(f_0^2 - f_c^2)} \quad (1)$$

$$L = \frac{1}{4\pi^2 f_0^2 C} \quad (2)$$

$$Y = \frac{1}{Z} = \frac{1}{R} + j \left( \omega C - \frac{1}{\omega L} \right) \quad (3)$$

$$S_{11} = \frac{Z_{in} - Z_0}{Z_{in} + Z_0} = \frac{1}{1 + 2Z_0 Y} \quad (4)$$

$$R(\omega) = \frac{1}{\frac{1}{2Z_0} \sqrt{\frac{1}{S_{11}(\omega)^2} + (2Z_0(\frac{1}{\omega L} - \omega C))^2} - 1} \quad (5)$$

where  $f_0$  and  $f_c$  are resonant frequency and -3 dB cutoff frequency, respectively.  $Z_0$  is the characteristic impedance of the circuit.

To simplify (5), we use a constant value for R obtained for  $\omega = \omega_0$  [8].

By using:

$$S_{21} = 1 - S_{11} = \frac{2Z_0}{2Z_0 + Z} \quad (6)$$

For  $\omega = \omega_0$ ,  $Z = R$  and then R is given by:

$$R = 2Z_0 \frac{1 - S_{21}(\omega_0)}{S_{21}(\omega_0)} \quad (7)$$

#### IV. SIMULATION RESULTS

##### A. Study of the Two Filters

###### • DMS Filter Etched from the Inside

The first presented DMS has four design parameters (a, b, d and e) as seen in Fig. 1. We vary each dimension of DMS keeping other parameters fixed.

Simulation results for the return loss coefficient with different values of the parameter a are shown in Fig. 4.

We see that the  $S_{11}$  parameter is at 5.25 GHz for  $a = 0.3$  mm, and it is more adapted at this frequency. Therefore the optimal result is found for this value of the parameter a.

Simulation results for the return loss coefficient with different values of b parameter are shown in Fig. 5.

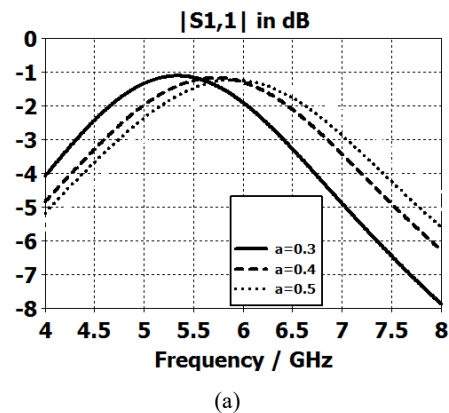

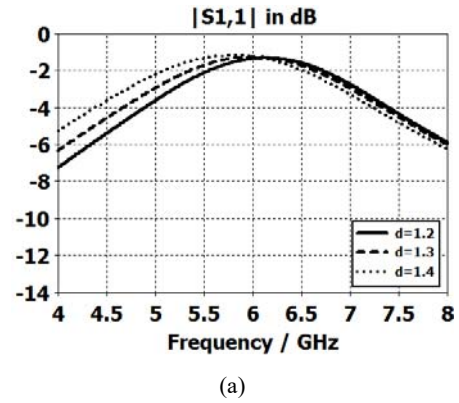
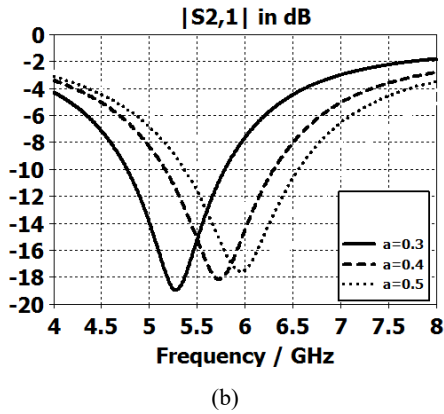

Fig. 4 Simulation of S11 (a) and S21 (b) with varied parameter a

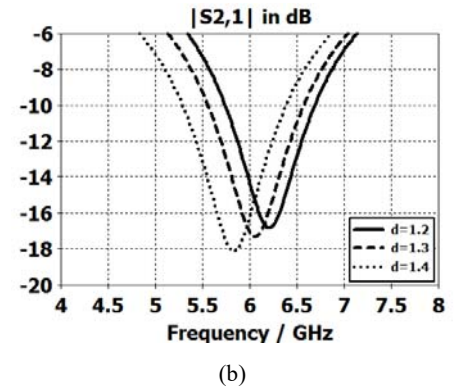
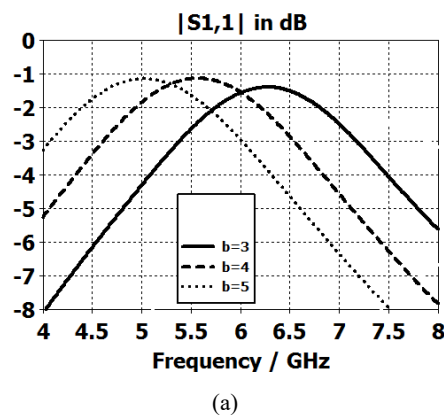

Fig. 6 Simulation of S11 (a) and S21 (b) with varied parameter d

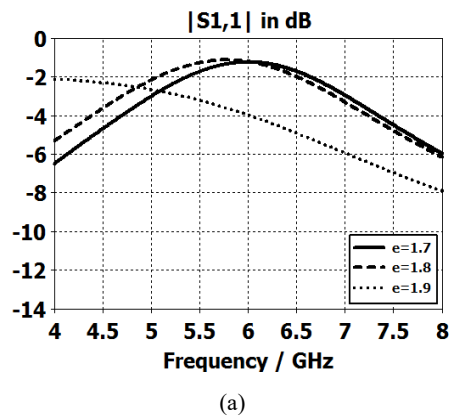
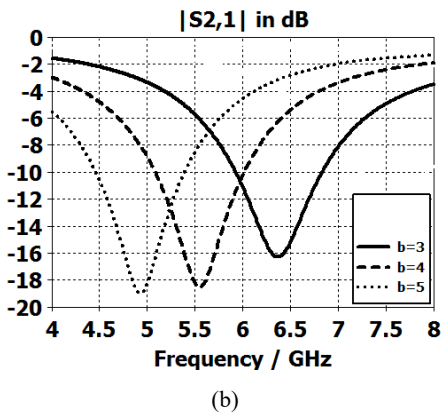

Fig. 5 Simulation of S11 (a) and S21 (b) with varied parameter b

From Fig. 7, we see that the S11 parameter is more adapted for b=5 GHz. Therefore the optimal result is found for this value of the parameter b.

Simulation results for the return loss coefficient with different values of d parameter are shown in Fig. 6. The optimal result is obtained for d=1.4 mm.

We see that the S11 parameter for d =1.4 mm is more adapted in comparison with other results for the same parameter. Therefore, the optimal result is found for this value of the parameter d.

Simulation results for the return loss coefficient with different values of e parameter are shown in Fig. 7.

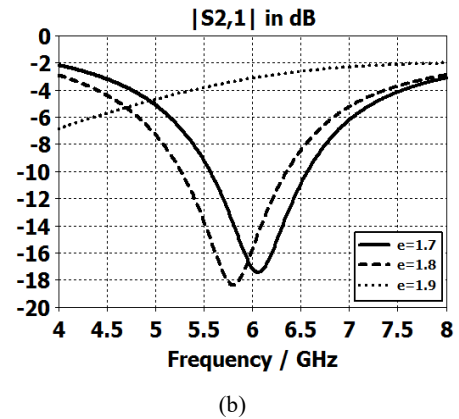

Fig. 7 Simulation of S11 (a) and S21 (b) with varied parameter e

The S11 parameter for the parameter e is more adapted for e=1.8 mm, therefore the optimal result is found for this value of the parameter.

The DMS dimensions optimized for desired performance are a= 0.3 mm, b=5 mm, d=1.4 mm and e=1.8 mm.

The simulation of the filter with optimal dimensions of the presented DMS is shown in Fig. 8.

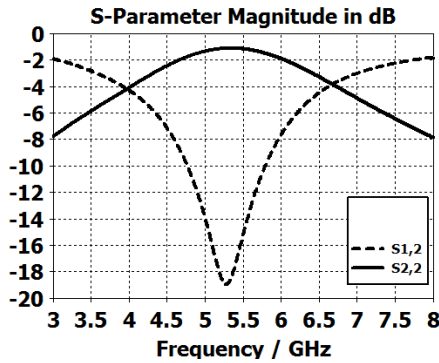

Fig. 8 Simulation of the filter with optimal parameters

From Fig. 8, we see that we have created a DMS filter which resonate at nearly 5.25 GHz, this filter can be used to suppress the 5.25 GHz harmonic of any device due it smallest size compared with conventional filters studied in literature.

Now we study the same dimensions of the previous filter but the following filter is not etched from the inside.

• *DMS Filter Not Etched from the Inside*

This filter has the same dimensions of the previous DMS filter but it is not etched from the inside (see Fig. 2).

The simulation of the DMS filter is shown in Fig. 9. As shown in Fig. 9, this filter resonates at 2 frequencies. It resonate at 5, 25 GHz (the same resonant frequency of the first filter), and at nearly 7.3 GHz. This filter can be used to suppress the 5.25 GHz and the 7.3 GHz harmonics of any microwave device. It is characterize by its smallest size and facility of integration.

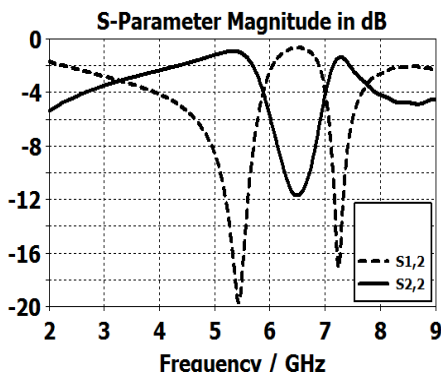

Fig. 9 Simulation of the DMS filter not etched from the inside

*B. E-Field Distribution*

• *DMS Filter Etched from the Inside*

Fig. 10 shows the E-field transmission of the DMS shaped

having the optimal dimensions.

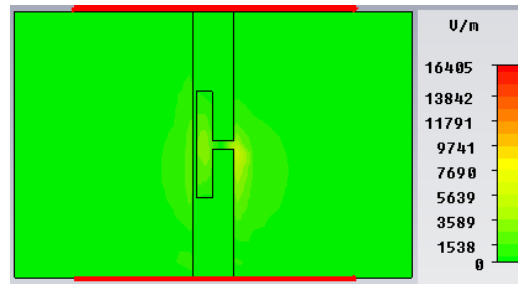
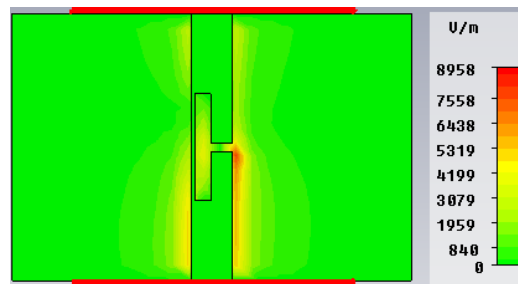
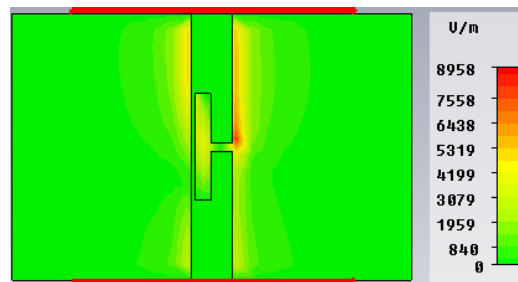

Fig. 10 E-field transmission of the DMS filter at 5.25 GHz



(a)



(b)

Fig. 11 E-field transmission of the DMS filter at 3 GHz (a) Snapshot of E-field transmission at port 1 (b) Snapshot of E-field transmission at port 2

The E-field snapshot at 5.25 GHz shown in Fig. 10 depicts that at 5.25 GHz the signal is not allowed to pass through and no output is obtained at the other end.

The E-feld snapshot at 3 GHz shown in Figs. 11 (a) and (b) depicts that at 3 GHz, the signal is allowed to pass from port 1 to port 2.

• *DMS Filter Not Etched from the Inside*

As studied previously with the first filter, Fig. 12 shows the E-field transmission of the filter DMS not etched from the inside.

The E-field snapshot at 5.25 GHz and at 7.3 GHz shown in Fig. 12 depicts that at these frequencies the signal is not allowed to pass through and no output is obtained at the other end.

The E-field snapshot at 3 GHz shown in Figs. 13 (a) and (b) depicts that at 3 GHz, the signal is allowed to pass from port 1 to port 2.

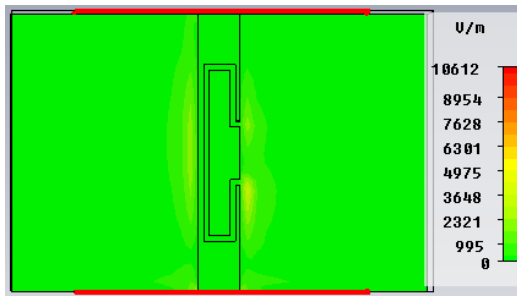

(a)

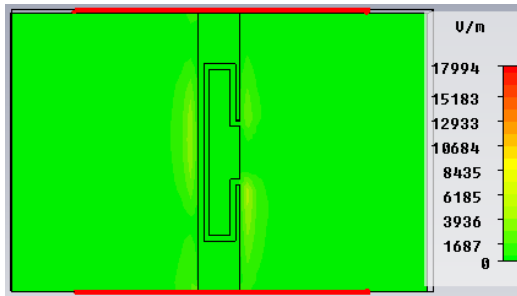

(b)

Fig. 12 *E*-field transmission of the DMS filter (a) Snapshot of *E*-field transmission at 5.25 GHz (b) Snapshot of *E*-field transmission at 7.3 GHz

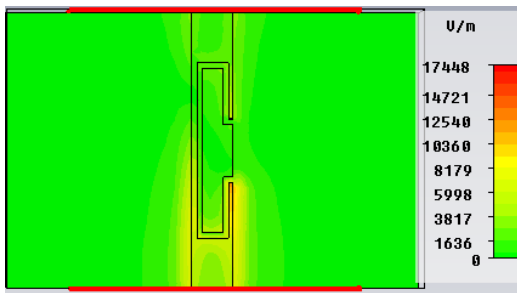

(a)

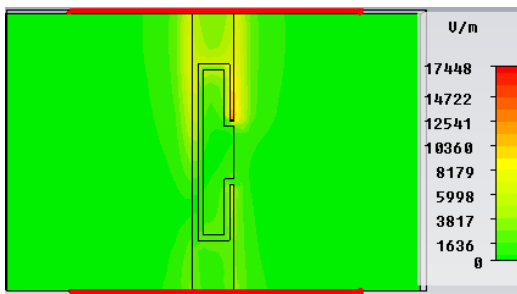

(b)

Fig. 13 *E*-field transmission of the DMS filter at 3 GHz (a) Snapshot of *E*-field transmission at port 1 (b) Snapshot of *E*-field transmission at port 2

The *E*-field snapshot at 5.25 GHz and at 7.3 GHz shown in Fig. 12 depicts that at these frequencies the signal is not allowed to pass through and no output is obtained at the other end. However, the *E*-field snapshot at 3 GHz shown in Figs.

13 (a) and (b) depicts that at 3 GHz, the signal is allowed to pass from port 1 to port 2. However, if the application requires elimination of this band of frequencies, additional filter elements are required, which can only be accomplished by adding these DMS filters in the Microstrip lines of devices at desired frequency band rejection.

#### V. CONCLUSION

This work presents a structure called DMS, which has been employed to suppress harmonics. DMS can be also used successfully in several applications such as reducing the size of devices like antennas and filters and it is easy to integrate with other components.

#### REFERENCES

- [1] Jun-Seok Park, Kookmin University, "An Equivalent Circuit and Modeling Method for Defected Ground Structure and Its Application to the Design of Microwave Circuits", *Microwave journal*, November 1, 2003.
- [2] Rahman, M. and Stuchly, M. A., "Transmission line-periodic circuit representation of planar microwave photonic bandgap structures," *Microw. Opt. Technol. Lett.*, Vol. 30, 15-19, Jul. 2001.
- [3] Yang, F. and Rahmat-Samii, Y., "Reflection phase characterization of an electromagnetic band-gap (EBG) surface," in *Proc. IEEE AP-S Dig.*, Vol.3, 744-747, June 2002.
- [4] Yang, F. and Rahmat-Samii, Y., "Microstrip antennas integrated with electromagnetic band gap structures: a low mutual coupling design for array applications," *IEEE Trans. Antennas and Propagation*, Vol. 51, 2936-2946, Oct. 2003.
- [5] Kim, C.-S., J.-S. Park, D. Ahn, and J.-B. Lim, "A novel 1D periodic Defected Ground Structure for planar circuits," *IEEE Microwave Guided wave letters*, Vol.10, No. 4, 131-133, 2000.
- [6] M. Kazerooni, N.P. Gandji, A. Cheldavi, and M. Kamarei, "A New Microwave Bandstop Filter Using Microstrip Structure (DMS)," *Progress In Electromagnetics Research Symposium Proceedings*, Moscow, Russia, August 18-21, 697-699, 2009.
- [7] M. Kazerooni, Dr. A. Cheldavi, and M. Kamarei, "Comparing the performance of defected Microstrip Structures (DMS) and Defected Ground Structure (DGS) in microstrip miniature circuits," *Iranian Conference on Electrical Engineering*, Volume 5, Communication field.
- [8] Elftouh, H., N. A. Touhami, M. Aghoutane, S. El Amrani, A. Tazon, and M. Boussouis, "Miniaturized microstrip patch antenna with defected ground structure," *Progress In Electromagnetics Research C*, Vol. 55, 25-33, 2014.
- [9] S. R. Hosseini, R. Sarraf Shirazi, and Gh. Moradi, "A Novel Defect Microstrip Structure (DMS) Coupled Line Band Pass Filter in C Band," *Progress In Electromagnetics Research Symposium Proceedings*, Moscow, Russia, August 19-23, 2012.
- [10] Susanta Kumar Parui, Somdotta Roy Choudhury, A. Roy, L. Murmu, Santanu Das, "Bandstop Filtering Characteristics of a New Spiral Defected Microstrip Structure (DMS)", *International Symposium on Devices MEMS, Intelligent Systems & Communication (ISDMISC)* 2011.