

Wireless Power Transfer Application in GSM Controlled Robot for Home Automation

Kaibalya Prasad Panda, Nirakar Behera, Kamal Lochan Biswal

Abstract—The aim of this paper is to combine the concept of wireless power transfer and GSM controlled robot for the application of home automation. The wireless power transfer concept can be well utilized to charge battery of the GSM controlled robot. When the robot has completed its task, it can come to the origin where it can charge itself. Robot can be charged wirelessly, when it is not performing any task. Combination of GSM controlled robot and wireless power transfer provides greater advantage such as; no wastage of charge stored in the battery when the robot is not doing any task. This provides greater reliability that at any instant, robot can do its work once it receives a message through GSM module. GSM module of the robot and user mobile phone must be interfaced properly, so that robot can do task when it receives message from same user mobile phone, not from any other phone. This paper approaches a robotic movement control through the smart phone and control of GSM robot is done by programming in Arduino environment. The commands used in controlling the robot movement are also explained.

Keywords—Arduino, automation, GSM controlled robot, GSM module, wireless power transfer.

I. INTRODUCTION

IN the era of industrialization and modernization, the emerging technologies have made human life better and easier. Home automation [1]-[3] is one such recent control technologies in which different electrical equipment such as control of lighting (both ON and OFF) appliances, security lock system, fire detection etc. can be done by the application of robots. The concept of robotics plays a vital role in home automation. Robots can control different home appliances through GSM controlled method or an image processing method which uses the concept of microcontroller.

The movement of robot can be controlled by different methods such as RF remote control, Wi-Fi, Bluetooth etc. But controlling the movement of robot by above methods has some disadvantages. In case of an RF remote control transmission, the robot consumes more power. So, to limit the power consumption the battery level of robot and the destination of robot should be properly taken into account. Bluetooth [4], [5] and Wi-Fi controlled robot suffers from the limitation that, the distance between control unit and the device should be limited.

K. P. Panda is Asst. Professor with the Department of Electrical Engineering, C. V. Raman College of Engineering, Bhubaneswar, Odisha, India (e-mail: kaibalya.mgr@gmail.com).

N. Behera and K. L. Biswal are final year students in the Department of Electrical Engineering, C. V. Raman College of Engineering, Bhubaneswar, Odisha, India (e-mail: bnirakar16@gmail.com, lochan.kamal000@gmail.com).

In contrast to this, the GSM controlled robot provides greater advantages. We can control the movement i.e. forward, backward, right, left by sending a message to robot from remote areas through user mobile phone. In this modern era, everybody uses smart phones which are a part of our day-to-day life for social networking, newspaper reading and all the applications like vehicle security, home automation control, health maintenance etc. has been designed in form of applications that can be easily installed in their hand-held smart phones. The user mobile phone should be properly interfaced with the robot i.e. by configuring GSM [6]-[9] shield with the Arduino development board. Password protection should also be implemented for allowing only authorized users to control the appliances.

This paper presents the automated approach of controlling the device in household application with wireless communication. The concept of wireless power transfer [10], [11] provides greater reliability to the GSM controlled robot, which is the main focus of this paper. In many literatures, author spotted the battery used in the robots can be charged, when it is not doing any task. This makes the operation unreliable and complex. So, wireless power transfer concepts are utilized here to charge the battery making the operation simpler. When the robot is not performing any task, then robot can come to the central zone and can charge itself wirelessly through wireless power transfer which provides the necessary power for charging the battery. Wireless power transfer can be used for the application such as pacemaker where the battery also needs to be charged wirelessly. The studies in [12]-[14] have some examples of internet based automation. However, they are not too feasible to be implemented as a low cost solution. In recent year, wireless power transfer and artificial intelligence techniques have made human life easier; as the functioning can be done very accurately by the tracing the movement of robot through user mobile phone whether it is doing work properly or not according to the given condition.

This paper is described in following sub-sections: In Section II, the wireless power transfer concept and its principle is explained with block diagram. Further, in Section III, all hardware requirements for designing GSM control robot is clearly explained. In Section IV, steps for interfacing the Arduino to the GSM shield and commands used in programming are described. The working model and its operation are described in Section V.

II. WIRELESS POWER TRANSFER

Wireless power transfer [15] is based on the principle of mutual inductive coupling which consists of transmitter and

receiver coils. Wireless power transfer is the transfer of electrical energy from a power source to an electrical load without the use of discrete man-made conductor. In this, a wireless transmitter connected to a power source conveys the field energy across an intervening space to one or more receiver, where it is converted back to an electric current and utilized. Mutual inductance is a phenomenon in which, when a current carrying conductor is placed near another conductor the current starts flowing in the nearby conductor and as a result voltage is induced in the same conductor. Magnetic flux induced in the conductor is responsible for the induced voltage.

Wireless power transfer is broadly classified into two types: 1) Electromagnetic Induction: It is also called as inductive charging used for long range power transfer. A magnetic field is created between two transmitting coils i.e. in the power source and the receiving coil in the target device. The closer the two coils the greater the efficiency. So, the devices are often placed on the charging mat. 2) Magnetic Induction: It is also called as resonant inductive coupling used for medium range power transfer. It is similar to electromagnetic induction, where the transmitter and receiver coil oscillate at the same frequency. However, devices can be charged from greater distance. As soon as the device is within the range, the data signals activate charging process. More the distance, the longer it takes to charge.

A. Block Diagram of Wireless Power Transfer

The block diagram of wireless power transfer and the circuit connection with different components are shown in Figs. 1 and 2 respectively. In wireless power transfer, a supply of 230 volts is connected to the one input side of HF transformer which gives a high frequency of 25 kHz on other input side and this high frequency ac passes through the primary coil. It consists of another set of coil i.e. secondary

coil. A high frequency is induced in the secondary, when the secondary coil is brought closer to the primary coil. This high frequency ac is converted to dc and the device connected to the secondary starts functioning. Here a 12 volt battery is used as load and as we are using battery in GSM controlled robot, so the concept of wireless power transfer can be used to charge the battery which can drive the robot.

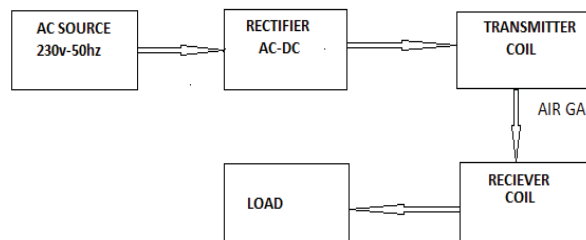

Fig. 1 Block diagram of wireless power transfer

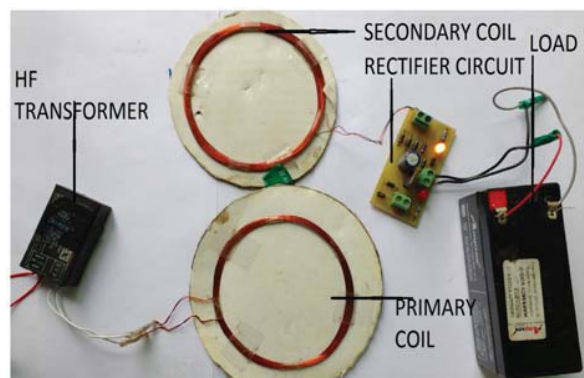

Fig. 2 Circuit connection of wireless power transfer

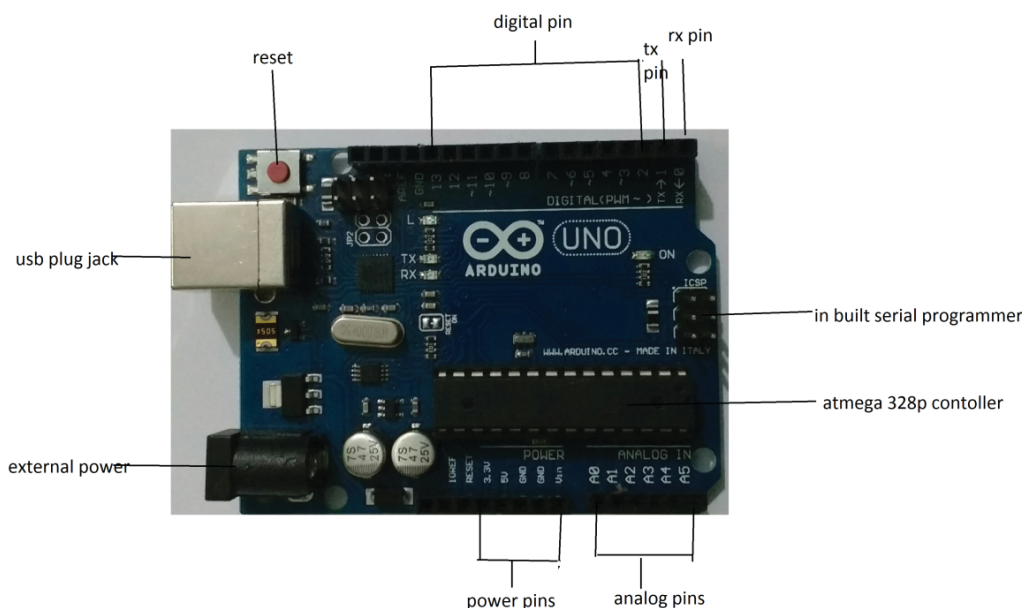

Fig. 3 Circuit of Arduino UNO

III. HARDWARE REQUIREMENT

A. Arduino UNO

Arduino Uno [16] shown in Fig. 3 is a microcontroller board based on the Atmega328P. It has a 16 MHz quartz crystal, a USB connection, a power jack, an ICSP header and a reset button. It also has 6 PWM input, 6 analog inputs; out of 14 digital input/output pin. It contains everything needed to support the microcontroller, simply connect it to the computer with a USB cable or power it with AC to DC adapter or battery to get started. The program required to control the GSM robot is done by using Arduino software.

B. Motor Driver

Function of the motor driver is to take a low current control signal and then turn into high current control signal that can drive a motor. The circuit diagram of L293D motor driver is shown in Fig. 4. L293D motor driver IC allows DC motor to drive on either direction. L293D is a 16 pin IC which can control a set of two DC motor simultaneously in any direction. It works on the principle of H-bridge. H-bridge is a circuit which allows the voltage to flow in either direction. The circuit has four ports in total; two for motor input and another two for motor output as well as one port for DC input.

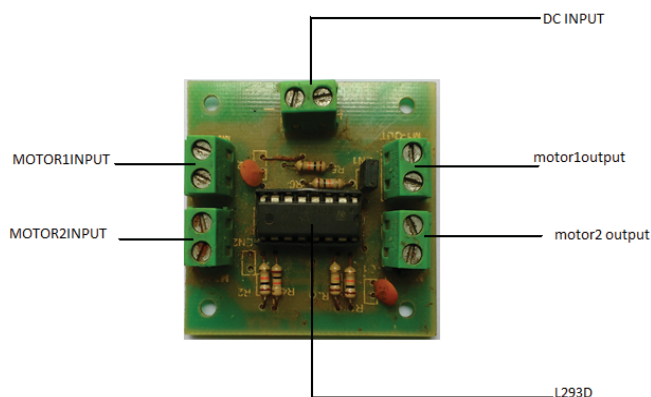

Fig. 4 Motor driver circuit

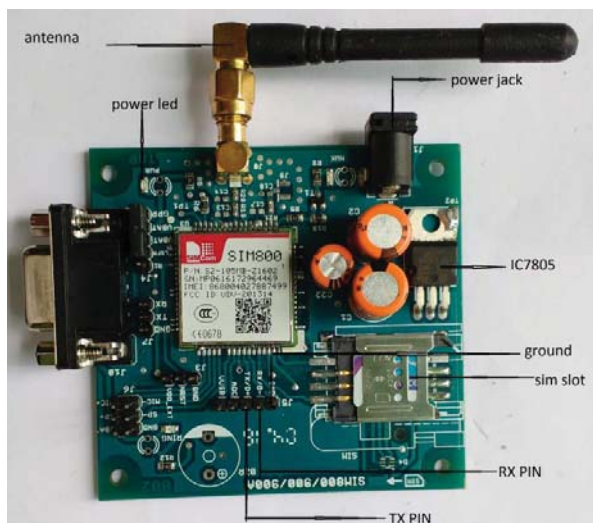

Fig. 5 GSM shield circuit configuration

C. GSM Shield

The SIM 900A GSM shield shown in Fig. 5 allows Arduino board to interface with GSM shield for sending/receiving message. It is possible to communicate with the board using AT commands. The shield uses a radio modem, digital pins 2 and 3 for software serial communication with the radio modem. Pin 2 is connected to TX pin and pin 3 to RX pin. There are two buttons on the shield known to be the RESET button. The button labeled RESET is tied to the Arduino reset pin; when pressed, it will reset the sketch. The bottom labeled POWER is connected to the modem and will power the modem ON or OFF.

D. On Board Indicators

The shield has a number of status LEDs:

- 1) ON-This shows that the Arduino shield has the power and is now ready to function.
- 2) STATUS-it turns on when the modem is powered and data is being transmitted to or from the GSM network.

IV. INTERFACING ARDUINO WITH GSM SHIELD

- 1) First connect the Arduino Uno to the laptop to see which COM port will be used to burn the program from the laptop. This also provides power to the Arduino Uno.
- 2) Connect a 12 volt supply to the GSM shield using an adapter.
- 3) For GSM programs; only 2 pins i.e. RX and TX are used mainly. These pins are, pin 0 and pin 1 of the Arduino Uno.
- 4) Burn the required program in Arduino Uno using the software.
- 5) Connect the GSM shield to Arduino such that RX, TX of the GSM shield is connected to the TX, RX pin of the Arduino Uno respectively.

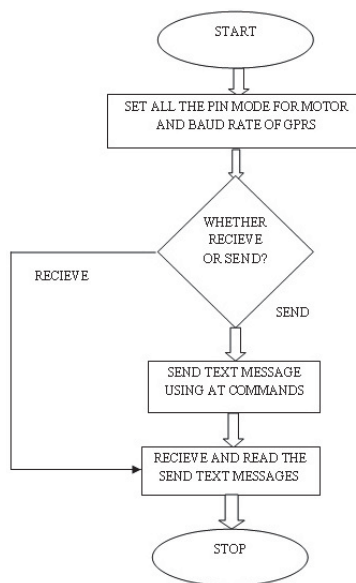

Fig. 6 Flowchart of the programming

A. AT Commands for Using GSM Shield

- 1) Checking Operation and Connection of the GSM Shield: Press AT+ENTER. This would print OK which signifies the connection and operation of the GSM shield are correct.
- 2) Sending the Text Messages: For sending text messages, type "AT+CMGF=1" and press ENTER. Once, AT command is given ">" prompt will be displayed on the screen. Type the text messages to be sent and press "CTRL+Z" to send the messages. "OK" will be displayed on the screen with the message number, if the message is sent successfully.
- 3) Reading the Text Messages: For reading the text messages, type "AT+CMGF=1" and press ENTER. For reading all the text messages sent by the sender, type "AT+CMGL=ALL". The flowchart for programming is shown in Fig. 6.

B. Programming Code

```
SoftwareSerial mySerial(7,8);//rx,rx pin
void setup()
{
  pinMode(m11,OUTPUT);
  pinMode(m12,OUTPUT);
  pinMode(m21,OUTPUT);
  pinMode(m22,OUTPUT);
  mySerial.begin(9600);//the gprs baud rate
  delay(500);
}
void loop()
{
  if(Serial.available(>0))
  switch(Serial.read())
  {
  case 't':
  SendTextMessage();
  break;
  case 'r':
  RecieveTextMessage();
  break;
```

```

}
if(mySerial.available(>0))
  Serial.write(mySerial.read());
}
void SendTextMessage()
{
  mySerial.println("AT+CMGF=1");//send the SMS in text mode
  delay(100);
  mySerial.println("Atext message!");//the control of the message
  delay(100);
  mySerial.println((char)26);//the ASCII code of the ctrl+z
  delay(100);
}
void RecieveTextMessage()
{
  mySerial.println("AQT+CMGF=1\r");
  delay(200);
  mySerial.println("AT+CMGL=\"ALL\"\r");//to read ALL the SMS in
  test mode
  delay(200);
}
```

V. GSM CONTROLLED ROBOT

GSM controlled robot is an automatic machine capable of moving around and performing various home applications. In GSM controlled robot, the robot performs necessary action by receiving a set of instruction in form of short messages. Fig. 7 shows the setup of the proposed robot model with all components and Fig. 8 shows the same with wireless power transfer structure. We can control the robot direction such as forward, backward, left, right and stop by sending a message. It consists of 2 sections; one is mobile unit and the other is control unit. In this case, GSM shield is used which connects the Arduino using GPRS wireless network system. The GSM shield allows Arduino board to send and receive messages. The communication with the board is done using AT command. The GSM library has some method to communicate with the GSM shield. The shield uses only two pins i.e. RX and TX pins. To interface with the cell phone network, the board requires a sim card provided by the network operator.

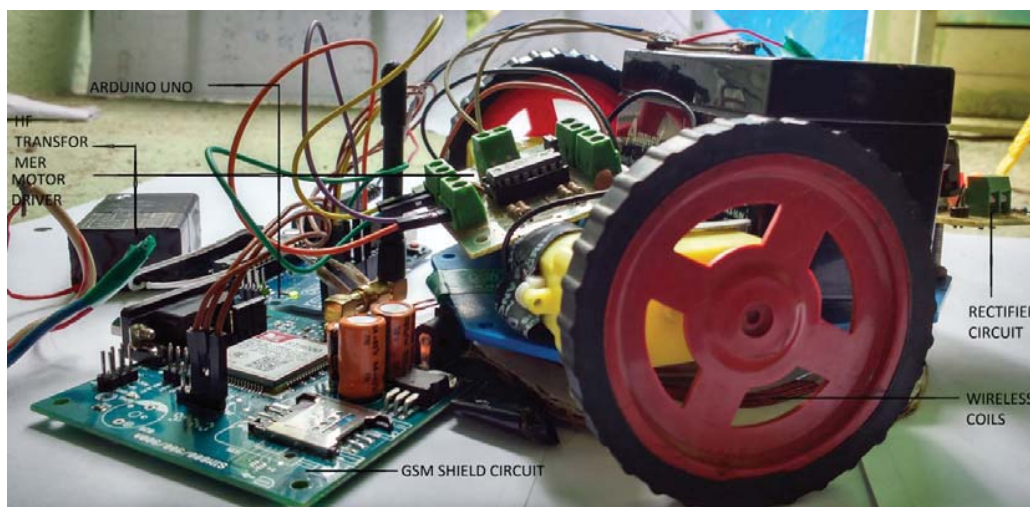

Fig. 7 GSM controlled robot

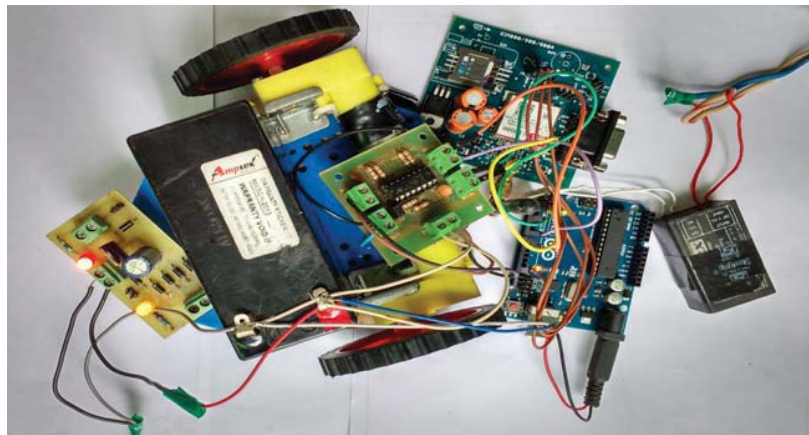

Fig. 8 GSM controlled robot through wireless power transfer

TABLE I
STEERING ANALYSIS OF TWO MOTORS USED FOR CONTROLLING ROBOT MOVEMENT

Movement of left motor	Movement of right motor	Robot direction
Forward	Forward	Forward
Forward	Backward	Right turn
Backward	Forward	Left turn
Backward	Backward	Backward
Stop	Stop	Stop

A. Movement of Motor Analysis

In this case two 70 rpm DC motor is used for controlling movement of the robot which is governed by the AT commands sent to the robot using the user mobile phone. The steering action analysis of robot obtained using two motors is shown in Table I.

VI. CONCLUSION

The design of GSM controlled robot for home automation using Arduino is explained in this paper. Use of wireless power transfer in proposed model has many advantages like, saving power loss or consumption of excess power by the battery and extra charging system for the battery is also not needed. When the robot is not performing any task, then it can charge itself without wasting the stored power in the battery. It can perform different home automation applications through the SMS service i.e. using AT commands for performing different home activities. Program for the robot functioning explained in this paper is done by using Arduino software. In case of unavailability of power, stored power from battery can be utilized to do the task. It is also observed that, the robot can function very well according to the conditions given to the microcontroller of the Arduino.

REFERENCES

[1] E. Yavuz, B. Hasan, I. Serkan and K. Duygu, "Safe and Secure PIC Based Remote Control Application for Intelligent Home", *International Journal of Computer Science and Network Security*, Vol. 7, No. 5, May 2007.

[2] J. C. Nunes and J. C. M. Delgado, "An Internet application for home automation", *Electrotechnical Conference, MELECON 10th Mediterranean*, Vol. 1, pp. 298 -301, May 2000.

[3] A. R. Al-Ali and M. AL-Rousan, "Java-Based Home Automation System". *IEEE Transaction on Consumer Electronics*, Vol. 50, No. 2, May 2004.

[4] R. Piyare and M. Tazil, "Bluetooth based home automation system using cell phone", *IEEE International Symposium on Consumer Electronics*, Vol. 15, June 2011.

[5] N. Sriskanthan, F. Tan and A. Karande, "Bluetooth Based Home Automation System", *Journal of Microprocessors and Microsystems*, Vol. 26, pp.281-289, 2002.

[6] H. D. Pham, M. Drieberg, Chi Cuong Nguyen, "Development of vehicle tracking system using GPS and GSM modem", in *Proceedings of IEEE International Conference on Open Systems (ICOS)*, pp.89-94, Dec. 2013.

[7] M. F. Saaid, M. A. Kamaludin and M. S. A. Megat Ali, "Vehicle location finder using Global position system and Global System for Mobile", *IEEE 5th Control and System Graduate Research Colloquium (ICSGRC)*, pp.279 – 284, Aug. 2014.

[8] S. Schneider, J. Swanson and Peng-Yung Woo, "Remote telephone control system", *IEEE Transaction on Consumer Electronics*, Vol. 43, Issue 2, pp.103-111, 1997.

[9] I. Coskun and H. Ardam, "A Remote Controller for Home and Office Appliances by Telephone", *IEEE Transactions on Consumer Electronics*, Vol. 44, No. 4, pp. 1291-1297. November 1998.

[10] B. T. Ranum et al., "Development of wireless power transfer receiver for mobile device charging", in *IEEE International Conference on Power Engineering and Renewable Energy (ICPERE)*, pp.48-51, Dec. 2014.

[11] R. Shepherd, "Bluetooth Wireless Technology in the Home", *Electronics & Communication Engineering Journal*, Vol. 13 Issue.5, pp. 195 -203, October 2001.

[12] Neng- Shiang Liang, Li-Chen Fu, Chao-Lin Wu, "An integrated, flexible, and Internet-based control architecture for home automation system in the internet era", in *Proceedings ICRA '02. IEEE International Conference on Robotics and Automation*, Vol. 2, pp.1101-1106, May 2002.

[13] K.Tan, T.Lee and C.Yee Soh, "Internet-Based Monitoring of Distributed Control Systems-An Undergraduate Experiment", *IEEE Transaction on Education*, Vol. 45, No.2, 2002.

[14] N. Swamy, O. Kuljaca and F. Lewis, "Internet-Based Educational Control Systems Lab Using Net-meeting", *IEEE Transaction on Education*, Vol. 45, No. 2, pp.145-151, May 2002.

[15] L. Olvitz, D. Vinko, T. Svedek, "Wireless power transfer for mobile phone charging device", in *Proceedings of IEEE International Convention, MIPRO*, pp.141-145, May 2012.

[16] The official Arduino website: <https://www.arduino.cc/>

K. P. Panda is presently working as Assistant Professor in Department of Electrical Engineering, C. V. Raman College of engineering, Bhubaneswar, Odisha, India. He received his M. Tech in Electrical Engineering with specialization in Power Electronics and Drives from KIIT University, Bhubaneswar, Odisha, India in the year 2013. His areas of research interest are Power electronics and drives, Power electronics application to Power system, Automation control and its applications.

N. Behera is presently a final year student in the Department of Electrical Engineering, C. V. Raman College of engineering, Bhubaneswar, Odisha,

India. He is currently working in the area of Automation, Wireless power transfer and Robotics.

K. L. Biswal is presently a final year student in the Department of Electrical Engineering, C. V. Raman College of engineering, Bhubaneswar, Odisha, India. He is currently working in the area of Robotics, PLC controlled drives, Wireless power transfer and its applications.