

High Performance of Direct Torque and Flux Control of a Double Stator Induction Motor Drive with a Fuzzy Stator Resistance Estimator

K. Kouzi

Abstract—In order to have stable and high performance of direct torque and flux control (DTFC) of double star induction motor drive (DSIM), proper on-line adaptation of the stator resistance is very important. This is inevitably due to the variation of the stator resistance during operating conditions, which introduces error in estimated flux position and the magnitude of the stator flux. Error in the estimated stator flux deteriorates the performance of the DTFC drive. Also, the effect of error in estimation is very important especially at low speed. Due to this, our aim is to overcome the sensitivity of the DTFC to the stator resistance variation by proposing on-line fuzzy estimation stator resistance. The fuzzy estimation method is based on an on-line stator resistance correction through the variations of the stator current estimation error and its variations. The fuzzy logic controller gives the future stator resistance increment at the output. The main advantage of the suggested algorithm control is to avoid the drive instability that may occur in certain situations and ensure the tracking of the actual stator resistance. The validity of the technique and the improvement of the whole system performance are proved by the results.

Keywords—Direct torque control, dual stator induction motor, fuzzy logic estimation, stator resistance adaptation.

I. INTRODUCTION

DUE to its robustness, the simplicity of its structure, its low cost, and which does not need a regular maintenance, the induction motor offers technological prospects in many industrial fields. Recently, there is an increasing interest towards multiphase motor drives, especially for medium and high power applications such as naval and railway propulsion systems. The use of multi-phase drives has been recognized as a viable approach to obtain high power ratings without increasing the stator current per phase, making it possible to use standard power switches based on a single device. Besides, multiphase motor drives possess several advantages over conventional three-phase motor drives, such as reducing the amplitude and increasing the frequency of torque pulsations, reducing the rotor harmonic currents, and improving the reliability and fault tolerance [1]-[4].

Direct torque control (DTC) of induction motor drives has gained popularity due to its simple control structure and sensorless operation. In DTC, the torque and flux are directly controlled using the selection of the optimum voltage vector.

The switching logic control facilitates the generation of the stator voltage space vector, with a suitable choice of the

switching pattern of the inverter, on the basis of the knowledge of the sector and the amplitude of the stator flux and the torque [5]-[7]. However, the conventional DTC technique has some drawbacks, such as large torque ripple in the low speed region according to the change of motor parameters especially the variation of the stator resistance due to temperature or frequency variations.

In the existing literature, many approaches have been suggested for of stator resistance online identification. These methods are based on the following schemes [1]:

- Proportional-integral (PI) or integral (I) controllers [1]
- Artificial intelligence techniques such as: Artificial neural network, Fuzzy logic, and neuro-fuzzy control [6].

In recent years, Artificial Neural Network intelligent (ANN) and Fuzzy Logic Controller (FLC) have gained great important and proved their dexterity in many respects [5]. It has great potential using to neural topology and does not need the mathematical model of the system to be controlled [6], [7]. On other hand, the FLC is mainly nonlinear and adaptive in nature, yielding robust performance under parameter deviation and load disturbance effect.

Fuzzy logic allows the formalization of inaccuracies due to global knowledge of a very complex system, and the expression of system behavior by words. Fuzzy approach uses linguistic descriptions of dynamic characteristics of a system provided by human expertise to generate a control law.

Based on the above point, this paper introduces a simple but powerful fuzzy PI stator resistance compensator using the measured stator currents. The main advantages of the suggested estimator are less complex and more effective than any other estimation strategies.

The main goal of the suggested DTC is a): To develop a robust DTC that allows direct and independent electromagnetic torque and flux control by selecting an optimal switching vector, making fast torque response possible, low inverter switching frequency and low harmonic losses. b): to avoid the DTC performance degradation and the instability problem, a simple but powerful fuzzy PI stator resistance compensator is proposed.

The outline of this paper is as follows: in section II, the DSIM model is presented. Section III, deals with DTC of DSIM. In Section IV, an analytic expression to evaluate the stator current command from the torque and stator flux is presented. The

K. Kouzi is with the Semiconductors and Functional Materials Laboratory, Electrical Engineering Department, Laghoua University, Algeria (e-mail: katia_kouzi@yahoo.fr).

conception of the fuzzy stator resistance estimator is presented in Section V. In Section VI, the performances of the presented DTFC algorithm associated with the fuzzy stator resistance estimator are illustrated by some simulation results. Finally, some concluding remarks are given in Section VII.

II. DUAL STATOR INDUCTION MOTOR MODEL

Under the assumptions of magnetic circuits linearity, and assuming sinusoidal distributed air-gap flux density, the equivalent two-phase model of DFIM motor, represented in a synchronous frame (d,q) and expressed in state-space form, is a fourth-order model [1]-[3]:

$$\dot{X} = AX + BU \quad (1)$$

with:

$$X = [\phi_{ds1} \phi_{qs1} \phi_{ds2} \phi_{qs2} \phi_{dr} \phi_{qr}]^T ;$$

$$U = [v_{ds1} v_{qs1} v_{ds2} v_{qs2} 0 0]^T ;$$

The system matrices are given by:

$$A = \begin{bmatrix} \frac{L_a - L_{s1}}{T_{s1}L_{s1}} & \omega_s & \frac{L_a}{T_{s1}L_{s2}} & 0 & \frac{L_a}{T_{s1}L_r} & 0 \\ -\omega_s & \frac{L_a - L_{s1}}{T_{s1}L_{s1}} & 0 & \frac{L_a}{T_{s1}L_{s2}} & 0 & \frac{L_a}{T_{s1}L_r} \\ \frac{L_a}{T_{s2}L_{s1}} & 0 & \frac{L_a - L_{s2}}{T_{s2}L_{s2}} & \omega_s & \frac{L_a}{T_{s2}L_r} & 0 \\ 0 & \frac{L_a}{T_{s2}L_{s1}} & -\omega_s & \frac{L_a - L_{s2}}{T_{s2}L_{s2}} & 0 & \frac{L_a}{T_{s2}L_r} \\ \frac{L_a}{T_rL_{s1}} & 0 & \frac{L_a}{T_rL_{s2}} & 0 & \frac{L_a - L_r}{T_rL_r} & \omega_{gl} \\ 0 & \frac{L_a}{T_rL_{s1}} & 0 & \frac{L_a}{T_rL_{s2}} & -\omega_{gl} & \frac{L_a - L_r}{T_rL_r} \end{bmatrix}$$

and,

$$B = \begin{bmatrix} 1 & 0 & 0 & 0 \\ 0 & 1 & 0 & 0 \\ 0 & 0 & 1 & 0 \\ 0 & 0 & 0 & 1 \\ 0 & 0 & 0 & 0 \\ 0 & 0 & 0 & 0 \end{bmatrix}$$

The mechanical modeling part of the system is given by:

$$J \frac{d\Omega_r}{dt} = T_{em} - T_l - k_f \Omega_r \quad (2)$$

Moreover, the electromagnetic torque is given by:

$$T_{em} = P \frac{L_m}{L_m + L_r} [(i_{qs1} + i_{qs2})\psi_{dr} - (i_{ds1} + i_{ds2})\psi_{qr}] \quad (3)$$

III. DTC OF DUAL STATOR INDUCTION MOTOR

The DTC method allows direct and independent electromagnetic torque and flux control, selecting an optimal switching vector. Fig. 1 shows a block diagram of the DTC scheme applied to the DSIM.

The reference values of flux ψ_s^* and torque T_{em}^* are compared to their actual values and the resultant errors are fed into a two-level hysteresis comparator for the flux and three-level hysteresis comparator for the torque, which allows for the controlling of the motor in two directions of rotation [8].

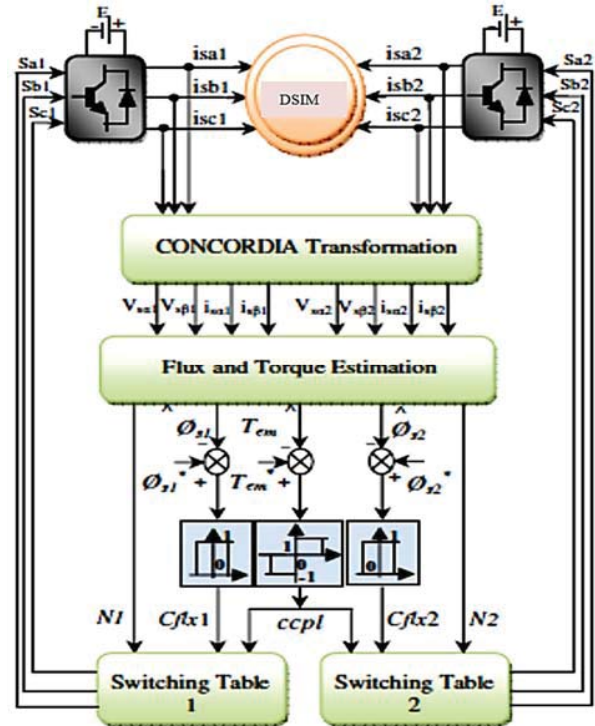

Fig. 1 DTC of DSIM

For the stator flux vector laying in sector 1, in order to increase its magnitude, the voltage vectors V_1 , V_2 , and V_6 can be selected. Conversely, a decrease can be obtained by selecting V_3 , V_4 and V_5 . However, to increase the electromagnetic torque, the voltage vectors V_2 , V_3 and V_4 can be selected and a decrease can be obtained by the vectors: V_1 , V_5 and V_6 (See Fig. 2).

The stator flux, as given in (4), can be approximated as (5) over a short time period if the stator resistance is ignored [9].

$$\bar{\psi}_s = \bar{\psi}_{s0} + \int_0^t (\bar{V}_s - R_s \bar{I}_s) dt \quad (4)$$

$$\bar{\psi}_s \approx \bar{\psi}_{s0} + \int_0^t \bar{V}_s dt \quad (5)$$

During one period of sampling T_e , vector tension applied to the machine remains constant, and thus one can write:

$$\bar{\psi}_s(k+1) \approx \bar{\psi}_s(k) + \bar{V}_s \cdot T_e \quad (6)$$

or

$$\Delta \bar{\psi}_s \approx \bar{V}_s \cdot T_e \quad (7)$$

The expression of the electromagnetic torque is given by [8]:

$$T_{em} = k_c \cdot \|\bar{\psi}_s\| \cdot \|\bar{\psi}_r\| \sin(\gamma) \quad (8)$$

where, γ is the angle between the stator and rotor flux linkage, k_c is constant depending on the parameters of the machine, and $\bar{\psi}_s, \bar{\psi}_r$ are the stator and rotor flux space vectors. Besides, the switching table is depicted in Table I.

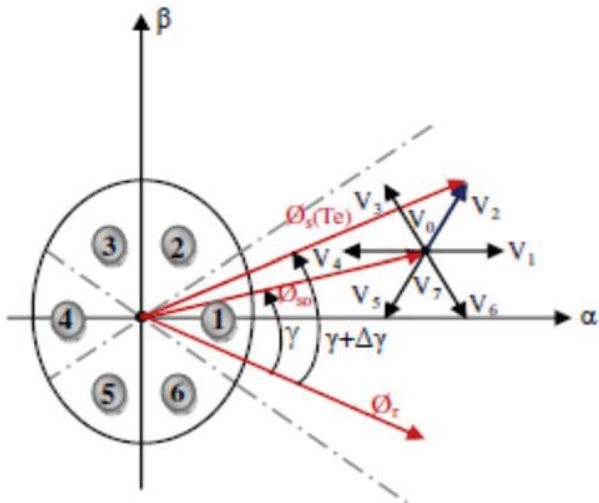

Fig. 2 Voltage vector selection

IV. STATOR RESISTANCE ESTIMATION MODEL

The stator current magnitude is given from the d and q stator currents as:

$$i_s = \sqrt{i_{sd}^2 + i_{sq}^2} \quad (9)$$

TABLE I
 SWITCHING TABLE WITH ZERO VOLTAGE VECTORS

Sectors		1	2	3	4	5	6		
cflx	0	ccpl	0	V ₃	V ₄	V ₅	V ₆	V ₁	V ₂
	0	ccpl	0	V ₀	V ₇	V ₀	V ₇	V ₀	V ₇
			-1	V ₅	V ₆	V ₁	V ₂	V ₃	V ₄
cflx	1	ccpl	0	V ₇	V ₀	V ₇	V ₀	V ₇	V ₀
			1	V ₂	V ₃	V ₄	V ₃	V ₆	V ₁
			-1	V ₆	V ₁	V ₂	V ₃	V ₄	V ₅

The stator command current magnitude \hat{i}_s is estimated from the induction motor dq model written in the synchronously rotating reference with the stator flux phasor using the torque command \hat{T}_e and the stator current linkage is as given by the following equations.

The torque equation is expressed by:

$$T_e = \frac{3}{2} p i_{sq} \varphi_s \quad (10)$$

Hence the estimated q-axis stator current is given from (10) by:

$$\hat{i}_{sq} = \frac{2}{3} \frac{\hat{T}_e}{p \hat{\varphi}_s} \quad (11)$$

And the estimated d-axis stator current is calculated from:

$$L_s \hat{i}_{sd}^2 - \hat{\varphi}_s \left(1 - \frac{L_s L_r}{M^2 - L_s L_r} \right) \hat{i}_{sd} + L_s \hat{i}_{sq}^2 - \left(\frac{\hat{\varphi}_s^2 L_r}{M^2 - L_s L_r} \right) = 0 \quad (12)$$

The resolution of (12) gives physical solution i_{sd}^* , from which we calculate the reference stator current magnitude according to:

$$i_s^* = \sqrt{(i_{sd}^*)^2 + (i_{sq}^*)^2} \quad (13)$$

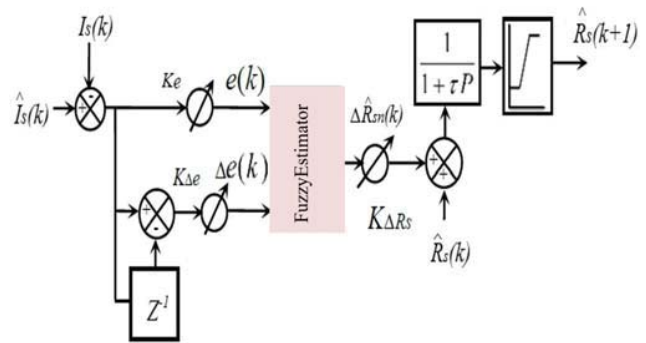

Fig. 3 Fuzzy stator resistance estimator

V. FUZZY STATOR RESISTANCE ESTIMATOR

The bloc diagram of the suggested fuzzy stator resistance estimator is shown in Fig. 4. The calculation of the future incremental value of the stator resistance $\Delta \hat{R}_{sn}(k+1)$ is based on the error between the estimated stator current $\hat{i}_s(k)$ and measured stator current $i_s(k)$ via the fuzzy estimator. This later has two input linguistic variables: the stator current error e and its variation Δe , and the output of the estimator is the future incremental value of the stator resistance $\Delta \hat{R}_{sn}(k+1)$ [9], [10]. The three fuzzy variables are given by:

$$e(k) = K_e (i_s(k) - \hat{i}_s(k)) \quad (14)$$

and its variation is:

$$\Delta e(k) = K_{\Delta e} (e(k) - e(k-1)) \quad (15)$$

Finally:

$$\Delta \hat{R}_s(k) = K_{\Delta R_s} \Delta \hat{R}_{sn}(k) \quad (16)$$

where $K_e, K_{\Delta e}, K_{\Delta R_s}$ gain factors of fuzzy stator resistance estimator.

The inputs and output variables of fuzzy estimator have been fuzzified using five triangular and trapezoidal shaped membership functions, as given in Fig. 4.

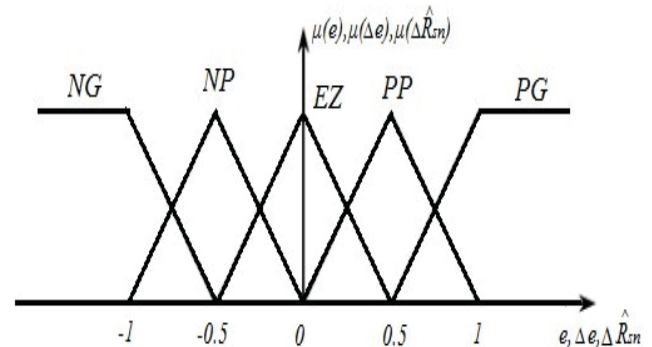

Fig. 4 Membership functions of inputs and output of fuzzy estimator

The five fuzzy sets are namely: NB: Negative Big; NS: Negative Small; EZ: Zero; PS: Positive Small; PB: Positive Big. Hence, 25 fuzzy rules were created. We have chosen the sum-product inference algorithm to complete the fuzzy procedure. The defuzzification process employs the gravity center method [11].

TABLE II
 INFERENCE RULES

$\Delta \hat{R}_{sn}(k+1)$	e(k)				
	NB	NS	EZ	PS	PB
NB	NB	NB	NB	NS	EZ
NS	NB	NB	NS	EZ	PS
EZ	NB	NS	EZ	PS	PB
PS	NS	EZ	PS	PG	PG
PG	EZ	PS	PG	PG	PB

TABLE III
 DSIM PARAMETERS

P_n	1.5 MW
V_n	220/380 V
P	2
R_{s1}, R_{s2}	3.72Ω
R_r	2.12 Ω
L_{s1}, L_{s2}	0.022H
L_r	0.006H
L_m	0.3672H
J	0.0662 kg m ²
K_f	0.001 N. m.s/rad

In the first stage, we start by showing that instability occurs in the DTC drive when the stator resistance is variable.

Fig. 6 illustrates the variation of stator resistance, which is assumed to be equal to its nominal value between 0.0 to 0.4 (s), then increases linearly to 100% between 0.4 and 0.8 (s) remains equal to two times its nominal value between 0.8 and 1.2 (s), decreases linearly to 50% between 1.2 and 1.6 (s), remains constant and equal to 150% of its nominal value between 1.6 and 2.0 (s) decreases linearly between 2.0 and 2.4 (s) remains equal to -50% of its nominal value from 3.0 (s).

VI. SIMULATION RESULTS AND DISCUSSION

To illustrate the effectiveness of the presented DTC algorithm of the DSIM drive with fuzzy stator resistance estimator, several tests were done at different dynamic operating conditions. The parameters of the test motor are given in Table III.

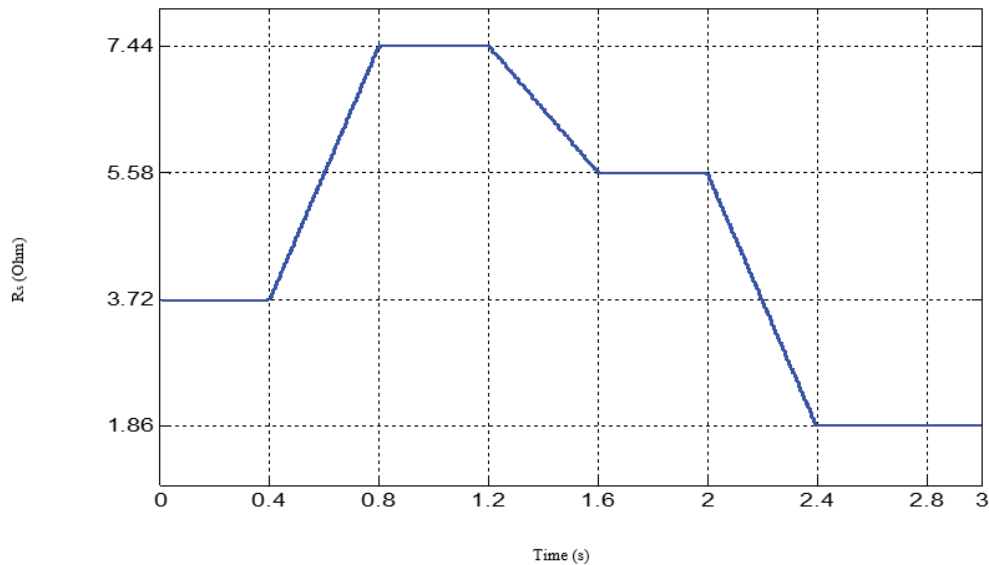
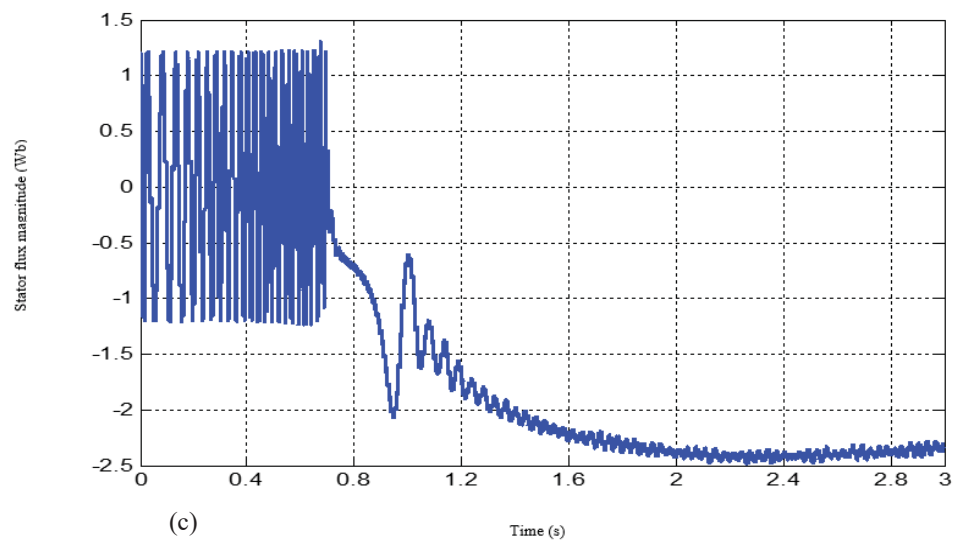
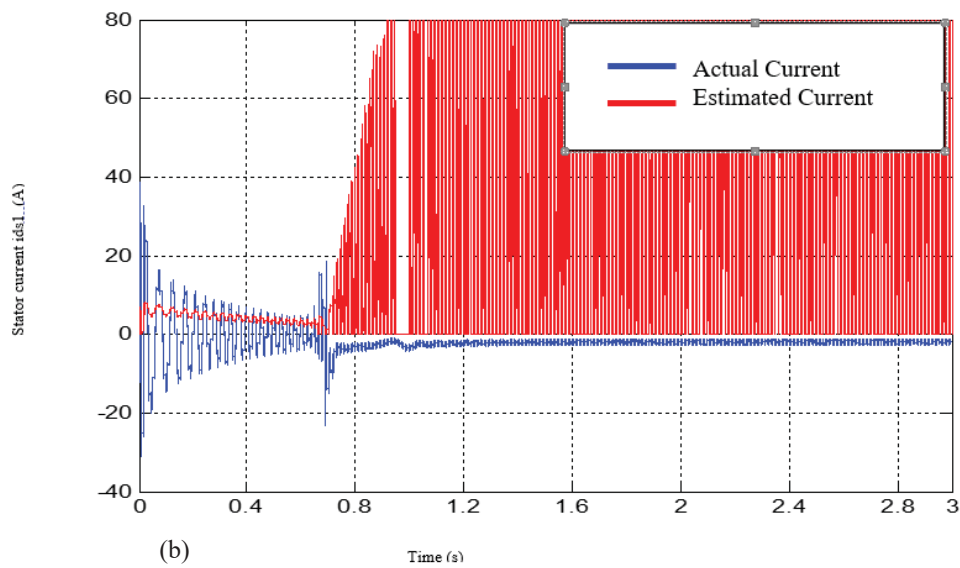
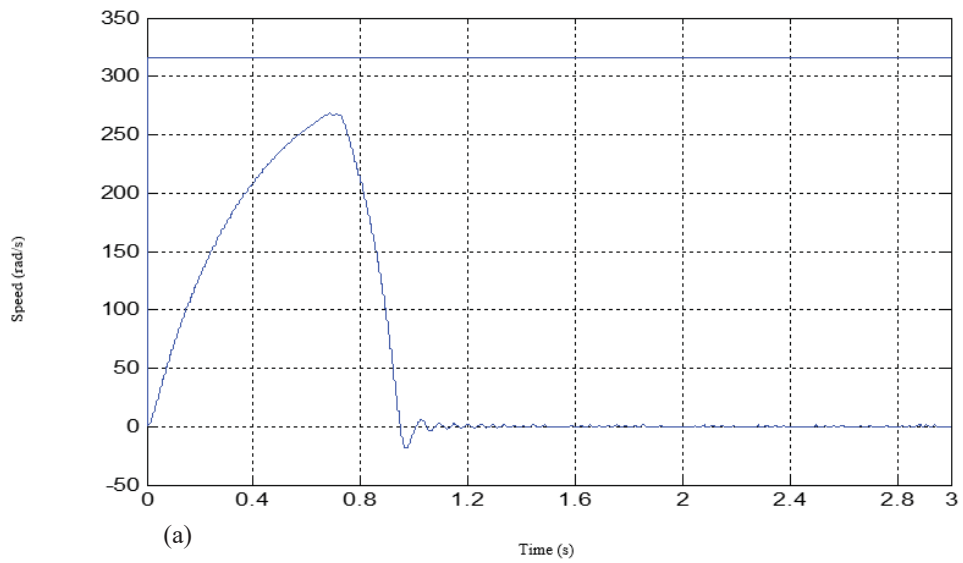

Fig. 5 Stator resistance variation



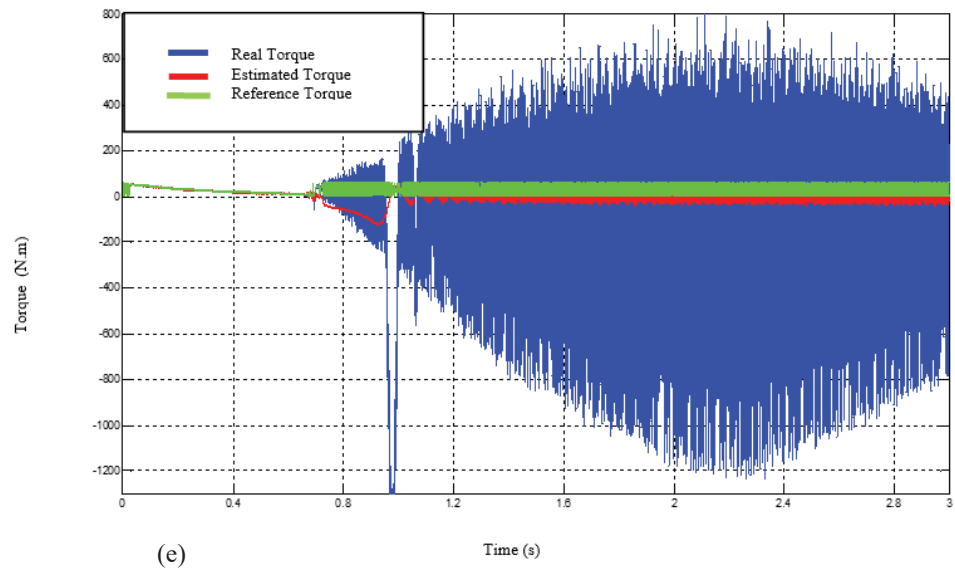
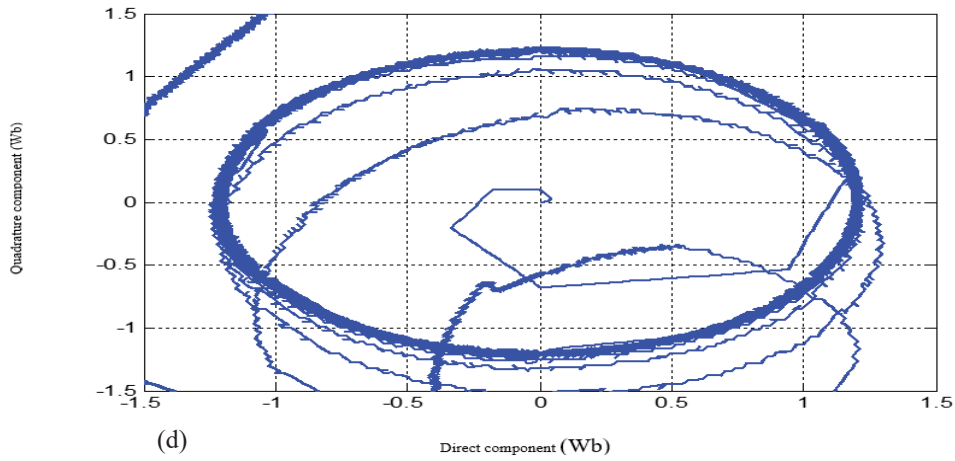

Fig. 6 Performance of the DTC without fuzzy estimator

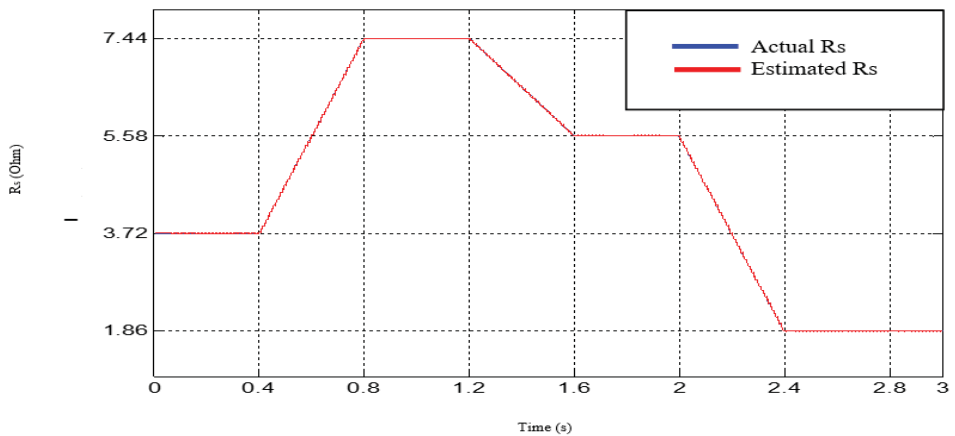
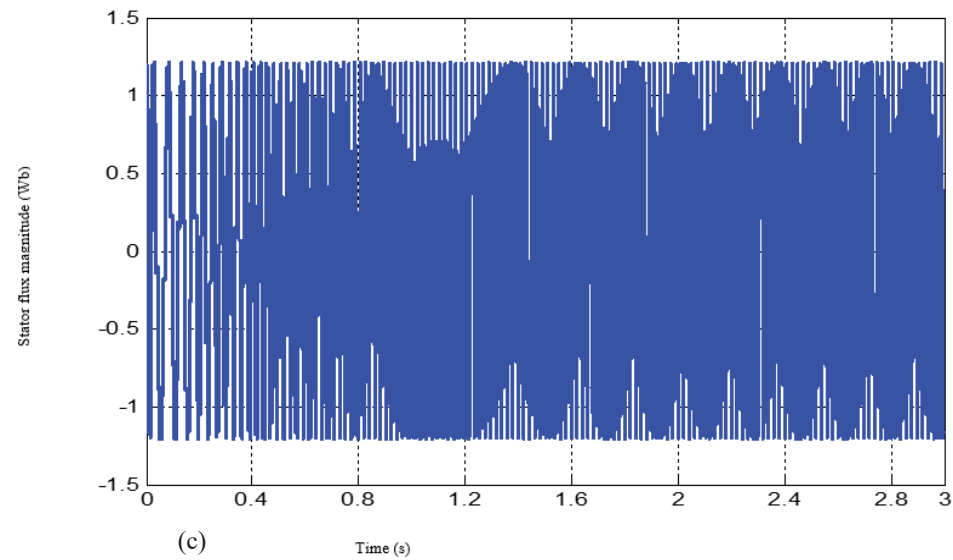
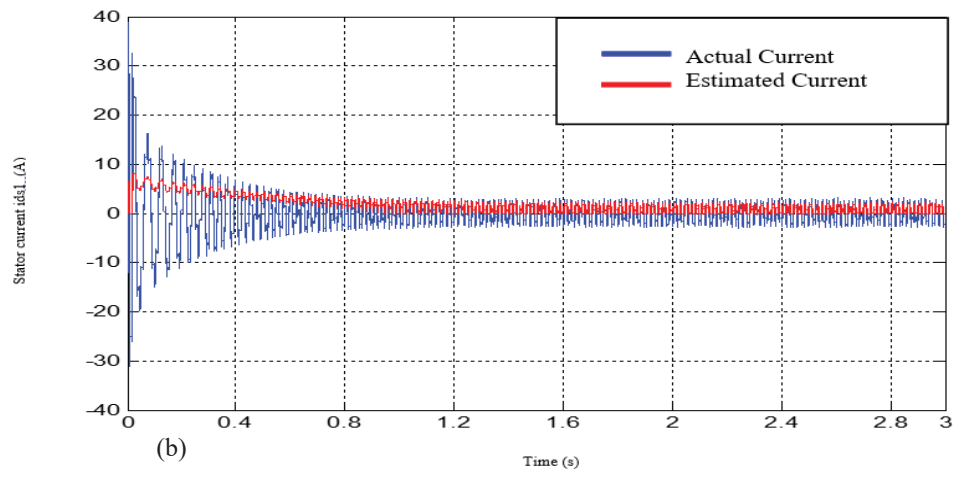
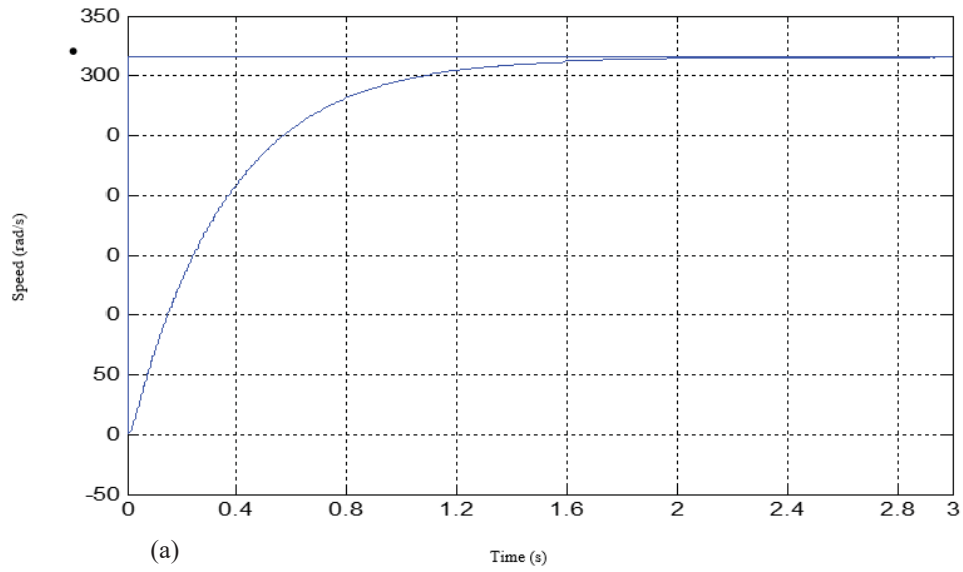

Fig. 7 Stator resistance estimation



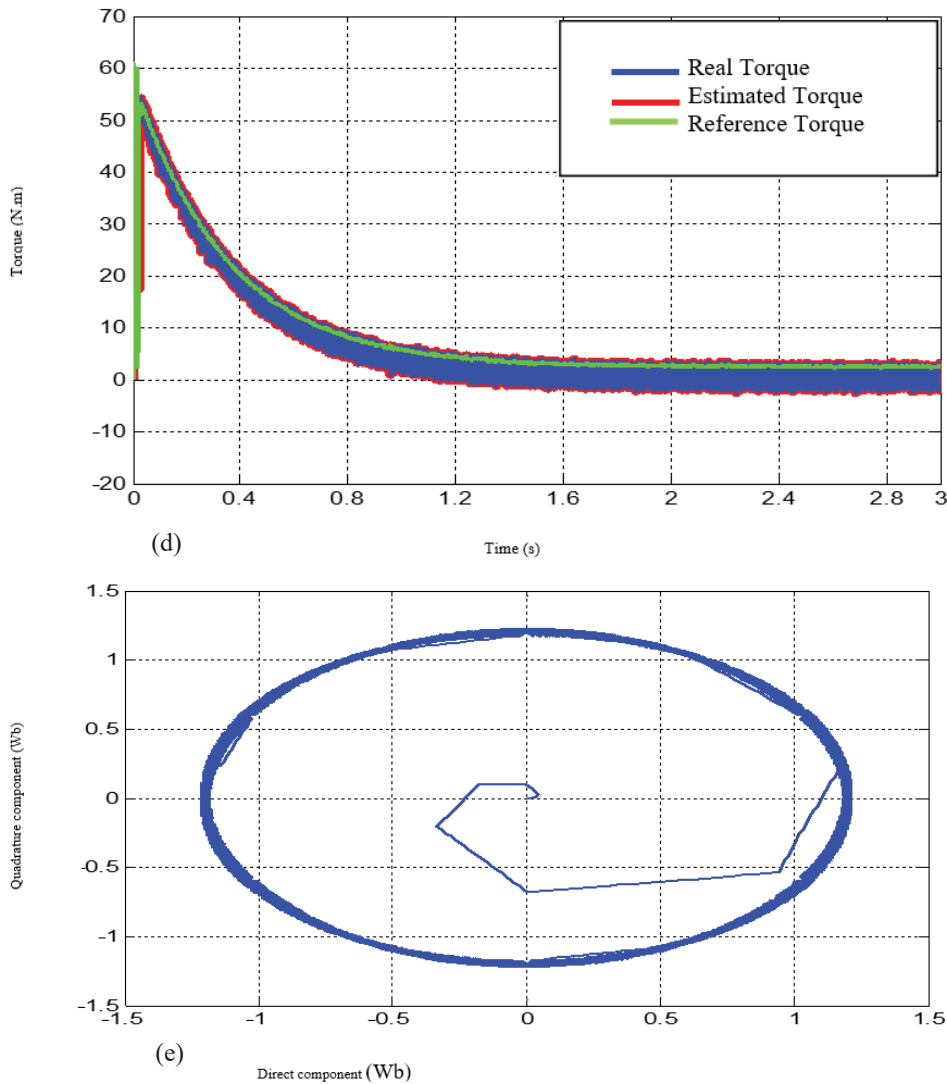

Fig. 8 Performance of the DTC with fuzzy estimator

Fig. 7 shows the dynamic behavior of some characteristics of the DSIM controlled by DTC against large variations of R_s . One can notice that the performance of the system becomes unstable; in fact, there is major static error in the stator current, electromagnetic torque and stator flux. Thus, the adaptation of the stator resistance is essential to overcome the instability and ensure a linear drive torque controlled.

The introduction of the fuzzy estimator in drive system of the DSIM can greatly improve the robustness of the system, see Fig. 8. In fact, the estimated stator resistance has tracked closely its actual value in steady state cases. Also one can note a good compensation of the electromagnetic torque and the stator flux, and a restoration of the stability of the system by eliminating the static error on the current and the stator flux and the electromagnetic torque.

VII. CONCLUSION

In this paper a new DTC algorithm of a dual stator induction motor with fuzzy stator resistance estimator has been presented. The performance of the proposed scheme has been simulated

under several changes of stator resistance. It is determined from the simulation results that the proposed fuzzy estimator of stator resistance has restored the drive system stability and has enhanced the robustness of the DTC drive of the DSIM against large deviations of stator resistance during operation of the DSIM.

NOMENCLATURE

$I_{qs1}, I_{ds1}, I_{qs2}, I_{ds2}$	dq stator current components
I_{qr}, I_{dr}	“d-q” rotor currents
$V_{qs1}, V_{ds1}, V_{qs2}, V_{ds2}$	“d-q” stators voltages
$\Psi_{ds1}, \Psi_{qs1}, \Psi_{ds2}, \Psi_{qs2}$	“d-q” stators flux
Ψ_{dr}, Ψ_{qr}	“d-q” rotor flux
T_{em}, T_l	Electromagnetic torque, Load torque
ω_{gl}	Sliding pulsation
ω_r	Rotor angular speed
Ω_r	Mechanical speed of DSIM

R_{s1}, R_{s2}	Per phase stators resistances
L_{s1}, L_{s2}	Per phase stators leakages inductances
L_m	Magnetizing inductance
R_r, L_r	Rotor resistance, rotor inductances

REFERENCES

- [1] M. Mengoni, L. Zarri, A. Tani, G. Serra, D. Casadei, "Sensorless Multiphase Induction Motor Drive Based on a Speed Observer Operating with Third-Order Field Harmonics," in *Conf. IEEE, Annu. Meeting*, pp. 68-74, 2011.
- [2] A. Nanoty, and A. R. Chudasama, "Control of Designed Developed Six Phase Induction Motor," in *International Journal of Electromagnetics and Applications 2(5)*, pp77-84,2012.
- [3] F. Ameur, and K. Kouzi "Genetic Algorithm Optimized PI and Fuzzy Logic Speed Vector Control of Dual Stator Induction Generator in Wind Energy Conversion System", in Proc of the 3rd International Conference on Systems and Control, pp. 174-180, Algiers, Algeria, October 29-31, 2013.
- [4] M. Boussak, and K. Jarray, "A High-Performance Sensorless Indirect Stator Flux Orientation Control of Induction Motor Drive," *IEEE Trans. Industry Elect.*, vol.53, no. 1, Feb, 2006, pp. 41-49.
- [5] R. Toufouti S. Meziane, H. Benalla, "Direct Torque Control for Induction Motor using Intelligent techniques," in Journal of Theoretical and Applied Information Technology, JATIT pp 35-44,2007.
- [6] A. Sudhakar*, M. Vijaya Kumar, "A Comparative Analysis of PI and Neuro Fuzzy Controllers in Direct Torque Control of Induction Motor Drives," *International Journal of Engineering Research and Applications (IJERA)* ISSN: 2248-9622 www.ijera.com Vol. 2, Issue 4, June-July 2012pp.672-680.
- [7] A. Abbou and H. Mahmoud, "Performance of a Sensorless Speed Control for Induction Motor Using DTFC strategy and Intelligent Techniques," *International Journal Electrical Systems 3-5.6(2009)*, pp64-81.
- [8] R. Sadouni and Ab. Meroufel, "Performances comparative study of Field Oriented Control (FOC) and Direct Torque Control (DTC) of Dual Three Phase Induction Motor (DTPIM)," *International Journal of Circuits, Systems and Signal Processing*, Issue 2, Volume 6, 2012 pp.163-170.
- [9] D. Ziane, A. Azib, N. Taib, and F. Rekioua, "Study and Design of the direct torque control of Double star induction motor in J. Electrical Systems (JES) 9-1 (2013), pp 114-124.
- [10] H. Huy, "Comparison of Field-Oriented Control and Direct Torque Control for Induction Motor Drives", IEEE 1999.
- [11] K. Kouzi, L. Mokrani, and M. S. Naït-Saïd, "A Fuzzy Logic Controller With Fuzzy Adapted Gains Based on Indirect Vector Control for Induction Motor Drive," In: *Journal of Electrical Engineering*, Vol. 3, n° 2, 2003, ISSN 1582-4594, pp. 49-54.