

# Evaluation of Seismic Parameters and Response Modification Factor of Connections in Reduced Beam Section

Elmira Tavasoli Yousef Abadi

**Abstract**—All structural components influencing the inelastic analysis alter response modification factor too. Ductility of connections has been regarded among the factors which have a direct impact on steel frame response modification factor. The experience of recent earthquakes such as the 1994 Northridge earthquake showed that structural connections in steel frame incurred unexpected (brittle) fracture in beam-to-column connection area. One of the methods to improve performance of moment frames is to reduce the beam section near the connection to the column. Reduced Beam Section (RBS) refers to one of the proposed moment connections in FEMA350. Ductility is the most important advantage of this connection over the other moment connections; it is found as the major factor in suitable plastic behavior of structural system. In this paper, beam-to-column connection with RBS and wide-flange beams has been examined via software Abaqus 6.12. It is observed that use of RBS connections can improve the connection behavior at inelastic area to a large extent and avoid stress concentrations and large deformation in the column.

**Keywords**—RBS, seismic performance, beam-to-column connection, ductility, wide-flange beam.

## I. INTRODUCTION

THE most important purpose in seismic design of structures is to avoid from collapse of structure during severe earthquakes which is the basis for the theories governing seismic behavior of structure. The result from overview of non-linear behavior of structure during earthquake and the resistance from its non-linear performance in rules and regulations of seismic project lies on numerical introduction entitled response modification factor to reduce linear design force to conduct structure toward non-linear performance. Response modification factor of structure has been assumed as a factor which encompasses the non-elastic behavior of the structure in severe earthquakes and depended on the parameters such as ductility factor, major period of structure, damping factor of structure, features of soil, features of earthquake, load behavior, structure deformation, overstrength factor, high modes involvement and factor of safety of design. Lateral resistance and ductility capacity have been regarded as the most critical factors governing the seismic capacity of buildings. An effective method to increase ductility and energy dissipation in a structure is to first develop a plastic hinge in beam, then in the panel zone connection and finally in

the column. Further, it has been stated that high deformation of connection panel zone in addition to relative deformation of story causes stress concentration at flange of column and adjacent to beam-to-column connections. In technical features of seismic project of US's steel structures, shear deformation of connection panel zone was restricted with its resistance control; further the task for energy absorption and providing connection deformation was devolved on establishment of plastic hinge at beam [1]. After the widespread destruction of steel structures during the 1994 Northridge earthquake and the Kobe, Japan Earthquake of Jan. 17, 1995, the criteria for design of steel beam-to-column connections in steel structures were revised so as to improve performance of these connections. In new designs of beam-to-column connections, beams to columns connections with RBS have been taken into account by many designers due to high ductility [2]–[6]. The main feature of this type of connection is increased ductility and response modification factor of structure. Creation of dog bone profile which is well known to bone connection in Iran can be made in three ways: direct bone, linear bone and radial bone. Another way to reduce the beam cross section is to create a series of holes in the flange of beam which these holes can have the same diameter or their diameter reduces along connection regarding their bending need. A variety of bone connections have been displayed in Fig. 1. In 1996, firstly direct RBS connection was developed and then its shape was corrected regarding the bending moment diagram under lateral loads and linear RBS connection was established. After that, due to stress concentration at the edges of linear RBS to create flat and smooth transitional zones, the radial linear RBS connection was introduced in late 1998's. Finally, due to administrative problems and the stiffness of cutting form of the flange in the linear radial RBS connection, RBS connection with radial incisions was proposed [7]. According to the results of the tests, among various proposed modes to reduce beam section at RBS connection, the most successful results relate to RBS connection with radial cutting. Further, the compositions in which asymmetric cuts or holes to varying size have been used to make balance in cross section and bending need have successfully been tested.

In Fig. 2, the direct and linear radial bone connections together with the flexural capacity and plastic hinge diagram have been displayed, indicating superiority of linear radial bone connections to direct bone connections [7]. In summary, in this type of connection, undermining a part of beam flange which is obtained through calculations paves the way for

Elmira Tavasoli Yousef Abadi is PhD student with the Sharif University of Technology-International Campus Kish Island, Iran (e-mail: elmiratavasoli@yahoo.com).

forming plastic hinge at a certain and controllable area, in such a way that plastic hinge is formed at the undermining area before the beam-to-column connection area is undermined and ultimately increasing ductility of structure will come to realize through formation of plastic hinge besides postponing destruction junction of the beams and columns (Fig. 3).

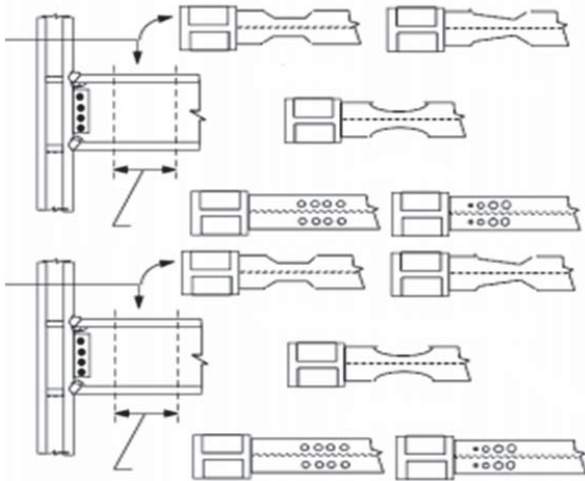

Fig. 1 Types of RBS connections

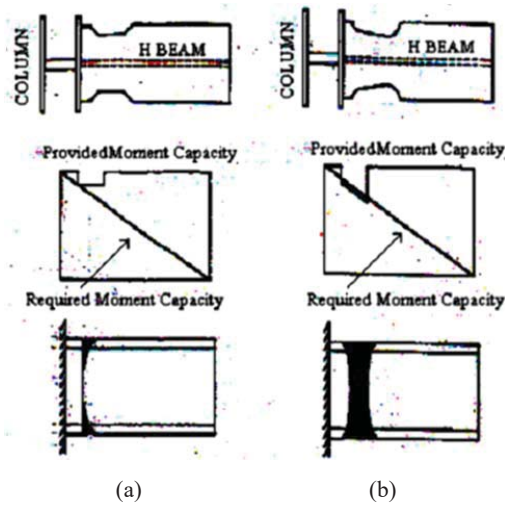

Fig. 2 Capacity diagram and bending moment (a) direct bone connection, (b) linear radial bone connection

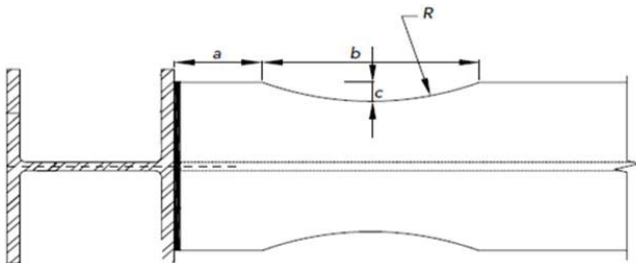

Fig. 3 Beam-to-column connection with RBS

Moslehi Tabar and Deylami [8] suggested acting as follow in design of RBS connections based on their studies:

- Cutting flange should be made in a way that the plastic moment capacity be under the required values to 5%-10%.
- Cutting flange should start from the area beyond the weld access hole to 5-10 cm from the column.
- A flat transitional area to 10 cm must be used before and after the considered area.
- Length of the considered area should be  $d0.5$ .

Results from inelastic analysis indicate that determination of turning point at ultimate resistance mode must be made by considering earthquake load effect. The problem with bone connection is that its load bearing capacity reduces in large displacements. The reason for this lies on undermining beam flange section and its effect on reducing section resistance than the deformations out of the plane, whereby this causes the beam is exposed to local and lateral buckling at narrowed area. Reduction in beam flange section causes local buckling and torsional and local buckling of flange in loading.

## II. THE EXAMINED SAMPLES

In this paper, two beam-to-column connection types (RBS and simple) with wide flange steel beams have been examined (Fig. 4 and 5); in these samples, wide flange steel beams (WF 100X100) have been used for beam and wide flange beams (WF 125X125) to model column, which the dimensions of sample for bone connections have been displayed in Fig. 4. The steel used in two samples for beam and column has been from type SS400 which has yield stress and ultimate stress (339 & 488 Mpa) (Table I).

TABLE I  
 FEATURES OF STEEL IN THE SAMPLES

Test Specimen	Steel grade	$\sigma_y$ (MPa)	$\sigma_z$ (MPa)	Y.R (%)	$EI_o$ (%)
Beam- Column	SS400	339	488	70	27

## III. CRITERIA FOR OPTIMUM CONNECTION

Connections can be classified by means of three major features: resistance, stiffness and ductility. When the resistance is taken into account, connections are divided into all the power or half-power depending on whether the resistance enables to transfer full plastic moment. When the stiffness is considered, the connections are divided into rigid, semi-rigid or simple connections regarding stiffness of connection against service load and ultimately connections are divided into ductile or brittle connections to use them in ordinary, intermediate and special moment frames based on their ability to incur rotational plastic need. Here, the criteria have been classified as follow so as to select the optimal connection:

1. Success in taking stress concentration away from beam-to-column connection (plastic hinge formation at this area causes large secondary stresses at beam-to-column flange connection)
2. The maximum ability in dissipation of energy which is witnessed in the hysteresis curve
3. Having more initial stiffness and less reduction in beam stiffness after applying load (connection must be stiff)

enough to consider it as a complete rigid connection)

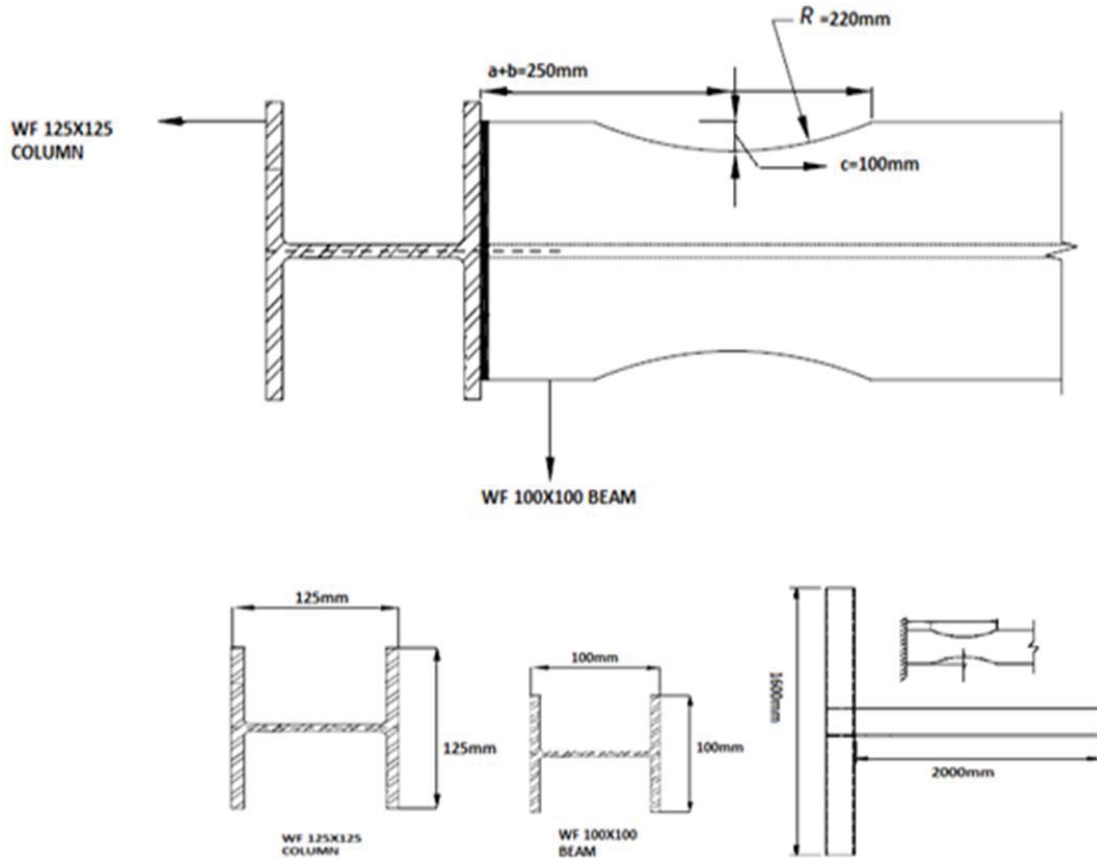

Fig. 4 Schematic of RBS beam to column connection

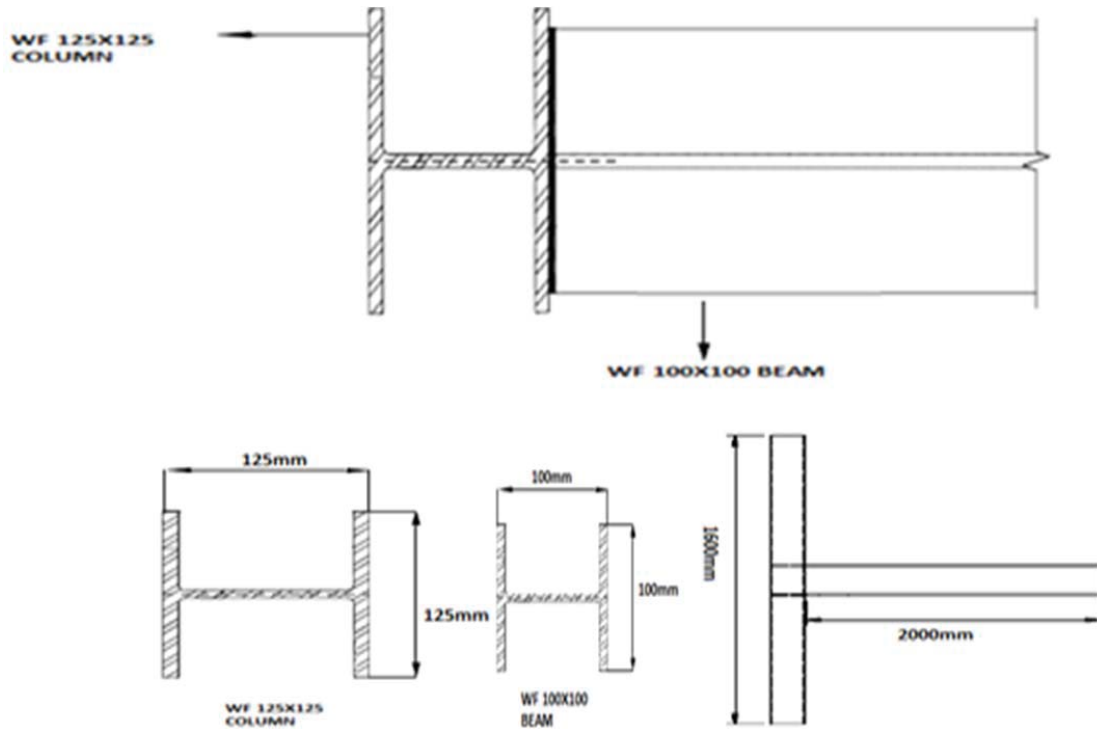

Fig. 5 Schematic of beam to column connection

The formation of plastic hinge in the frames under the seismic forces is inevitable because the lateral force causes emergence of flexural and/or nonlinear shear strains in various parts of the frames and raises non-linear deformation, resulting in the formation plastic hinges. These joints raise significant rotation by circulating tensile and compressive cords.

Connection has to be such that the plastic hinges are developed in the predetermined sections by raising required plastic deformation. This raises local failures.

#### IV. PERFORMANCE OF SAMPLES IN LOADING

Nowadays, concept of energy in structures has been regarded as one of the parameters which has been considered as behavior of structures in researchers' modern outlook. Hysteretic energy which is dissipated after yield in hysteresis loops has a major effect on creation of structural damage, considered as the most important part of energy applied to the structure. Hence, it can assist for control of structure behavior and damage to it by control of this amount of energy. The amount of hysteretic energy in a structure can be an indicator of the level of damage or the amount of softness. To evaluate vulnerability of steel frame, it can use various indicators such as Park–Ang damage index due to effect of hysteric energy in it. Park–Ang damage index can be used to evaluate vulnerability of steel skeleton due to effect of hysteric energy on it. Park–Ang damage index can be defined for a structural element as:

$$DI = \frac{\delta_m}{\delta_u} + \frac{\beta}{\delta_u P_y} \int dE_h \quad (1)$$

where  $\delta_m$  represents maximum deformation caused by the earthquake load,  $\delta_u$  represents ultimate deformation of element,  $P_y$  represents yield limit resistance,  $\beta$  represents yield limit resistance, and  $\int dE_h$  represents hysteretic energy absorbed by element during the response history. To reduce the nominal resistance, Park and his colleagues have suggested  $\beta = 0.1$ . Three damage indices are calculated via this model.

- Damage index of element: Beams and columns
- Damage index of story: Horizontal and vertical components and the entire damage to the story
- Damage to building

Figs. 6 (a) and (b) display image of finite element analysis for two models with simple and RBS connection which have been modeled via software Abaqus 6.12. Figs. 6 and 7 display loading place and cycle for two samples in terms of displacement (mm)-time (second), mentioned that end of the beam has been where to which forced has been applied. Providing the required ductility of structure has been regarded as one of the most important aims at seismic standards because the structure will enable to depreciate a significant amount of earthquake energy under such conditions. Beam to column connections and their behavior in structures due to their importance in seismic loads have been regarded as one of the most important parts in analysis of steel frames. To examine this behavior, it should pay attention to the parameters of resistance, stiffness and connection ductility; the hysteresis curves under cyclic loads allow examining these three important parameters of connections which this curve can be obtained via various modeling methods such as laboratory methods, numerical methods and empirical methods.

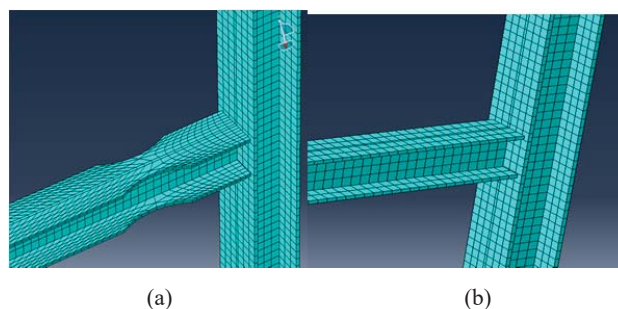

Fig. 6 Finite element model (a) RBS connection, (b) simple connection

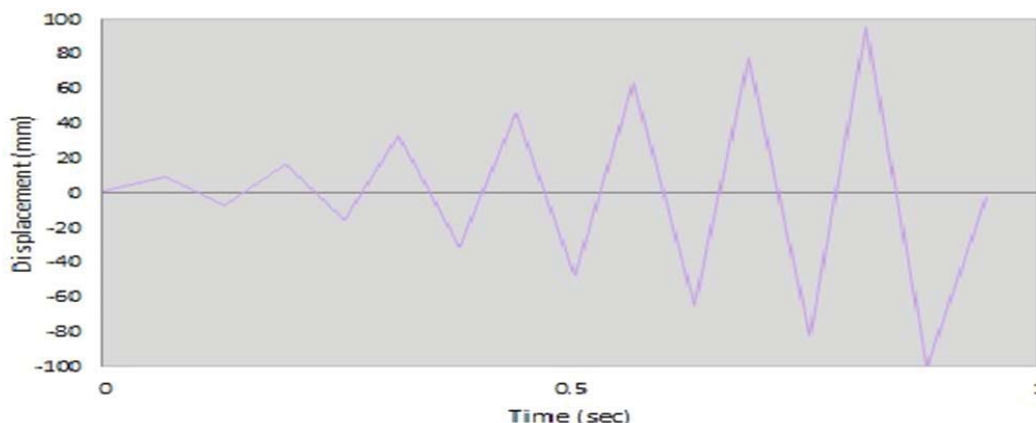

Fig. 7 Loading cycle of samples in terms of displacement (mm)-time (sec)

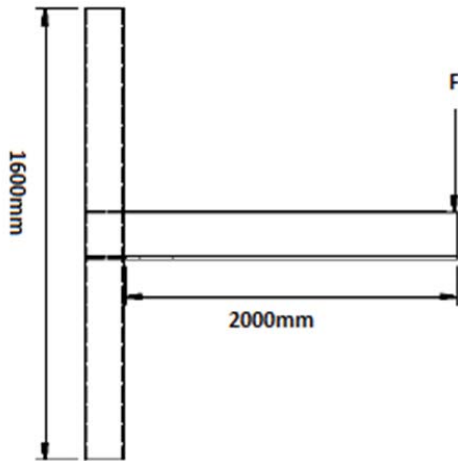

Fig. 8 The location to applied load

Laboratory studies on bone connections indicate that these connections enjoy significant ductility. RBS area with its plastic function absorbs greater amount of energy than joint with limited length to column, raising an unlimited controlled joint with significant ductility resulting in increase of period and response modification factor of structure. In addition, laboratory studies on these connections under cyclic loads indicate that ultimate resistance of these connections to moment resisting connections remain without change, so that just stiffness changes and capacity of plastic rotation increases to large extent. Using these connections, failure caused by welding sensitivity and stress concentration due to sudden changes in geometry reduces and energy dissipation capacity improves. Bone connectivity by yielding the beam causes reduced welding sensitivity and avoided stress concentration on the welds and caused more reliable energy dissipation. Results from comparative tests on similar steel moment frames with normal and RBS moment resisting connections indicate that bending frames with RBS connections outperform common moment frames [7]. Reliability of RBS connections depends on to quality of welding with thorough penetration of beam flange to column flange. Lack of suitable details on slab in RBS connections might prevent from fuse behavior at reduced part of the beam section. Extensive laboratory studies indicate that it can acquire the plastic rotation angle larger than 0.04 radian which is larger than average plastic rotation in old connection method using the proposed connection method. Hysteretic energy which is dissipated after yielding in hysteresis loops has a major effect on the development of structural damage at system, found as the most important part of the energy to the structure. Hence, control of this amount of energy can be conducted to control in behavior of structure and the extent of damage to structure. Amount of hysteric energy in a structure can be an index of damage to structure. Yet this amount will never display damage distribution in various elements of structure, behavioral form of structure and type of yielding mechanism. Fig. 9 and 10 display hysteresis curve (a & b) and comparison of hysteresis chart of two samples. As observed, loops are wider in the Hysteresis chart relating to wide flange beam

(RBS) than simple column, indicating improvement in performance of beam-to-column connection ductility which amount of dissipated energy is greater than energy in RBS connection.

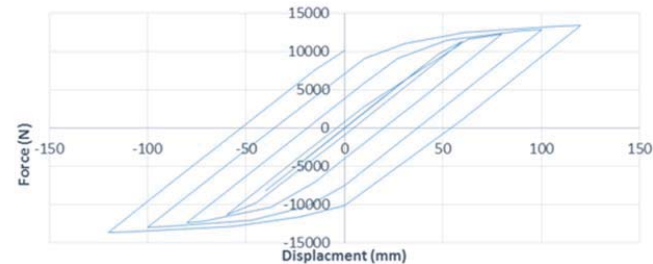
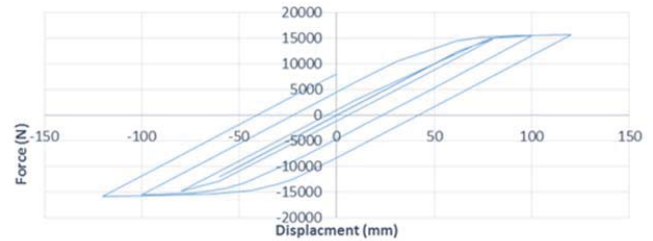

Fig. 9 Hysteresis curve for wide flange beam-to-column RBS connection model and simple beam-to-column connection

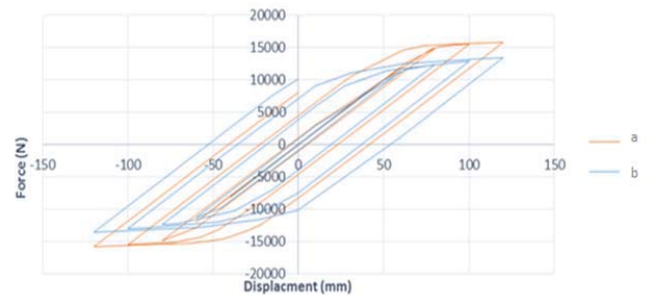

Fig. 10 Comparison of hysteresis curve (a-simple connection, b- wide flange beam-to-column connection)

#### V. STRESS CONCENTRATION IN CONNECTION SECTIONS

Prevention from inelastic deformations in many columns is one of the major aims of design which the reason lies on minimization of harmful outcomes of high axial loads on bending behavior and creation of mechanism in one story. Regardless of the acts for design of strong column- weak beam philosophy mentioned in AISC 341, 9.6, a significant inelastic rotation might be incurred in large earthquakes. Thus, local buckling and lateral torsional buckling will be of potential modes of failure which should be considered together with bending buckling of columns. Connections should have the capacity for shear and moment transmission which raises in beam to column. A significant point lies on this fact that the moment and shear force can fall larger than the forces obtained from analysis due to overstrength of materials and strain stiffness. With regard to the type of connection which is used, it can raise the rupture modes below:

- Spontaneous weld failure or around it
- Failure in base metal which has subjected to strain
- Failure in welding access holes

#### VI. RBS EFFECT IN PREVENTING FROM BRITTLENESS OF THE CONNECTION AND TENSION CONTROL IN COLUMNS

Effect of RBS in prevention from brittleness and control of excessive tensions in column has been examined in an analytical study calibrated with test on radial RBS connections by Thanaei & Jamasbi [9], [10]. Maximum moment in each of samples in column and middle of beam has been compared. Maximum ratio of moment on column to plastic moment of section in the samples with RBS connection ranges from 0.83 to 0.98, yet this ratio falls above 1.05 for ordinary

connections. These values indicate suitable performance of RBS connections in control of tensions on column and as the result prevention from connection brittleness. Maximum ratio of moment in the reduced area to plastic moment in the smallest section in RBS connection ranges from 1.04 to 1.28, indicating rise of plastic hinge in these areas and substantial dissipation of energy. Fig. 10 displays the stress contours for RBS connection and simple beam-column connection with wide flange beams in two different steps of loading cycles. As observed in Fig. 11, extent of stress concentration at the point of beam to column connection has been less at column web and a major part of stresses has been at the beam flanges in beam, while stress concentration is tangible at column's web in simple beam-to-column connection.

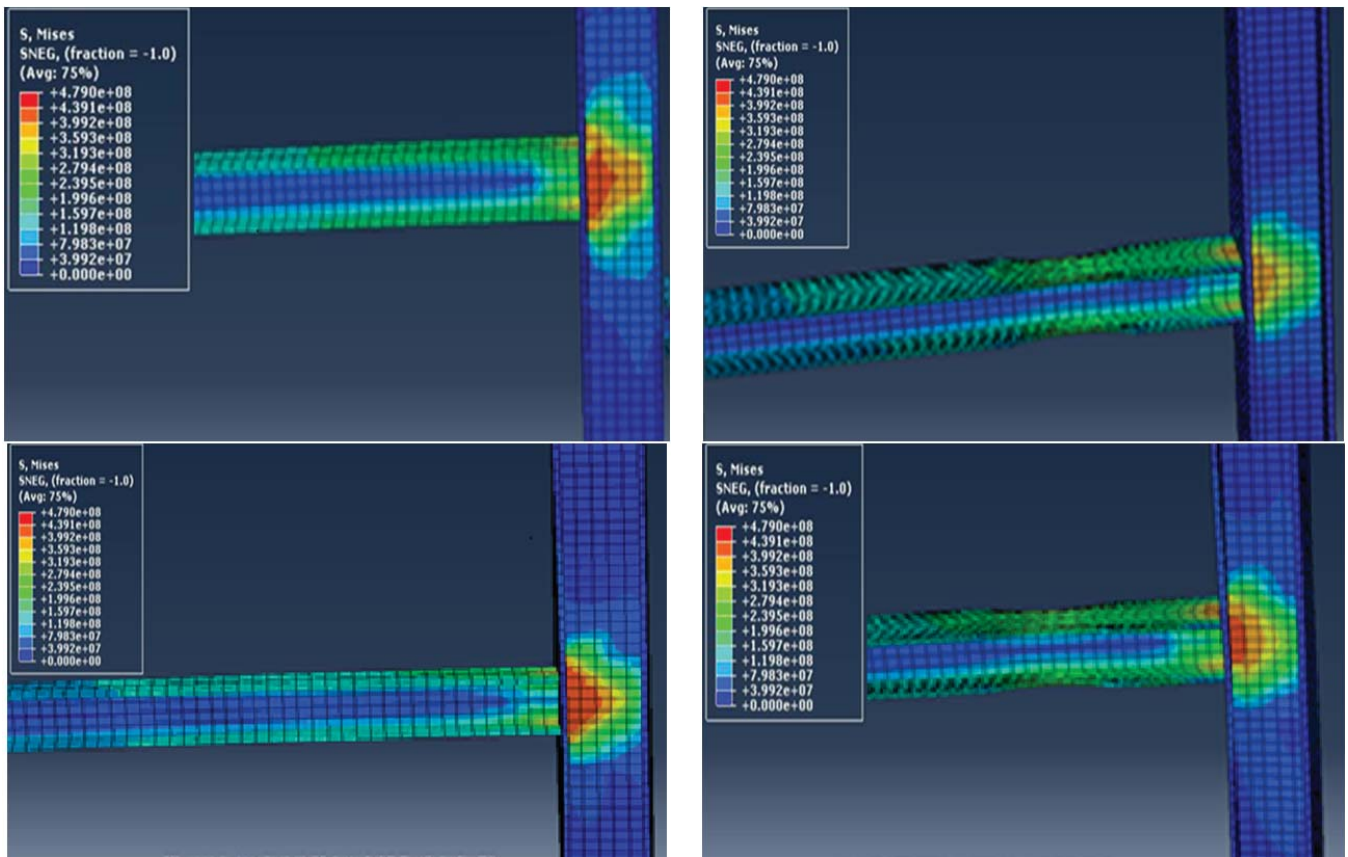

Fig. 11 Stress contours for simple and RBS connection at two different steps of loading cycle

Ideal Panel Zone is called to a panel zone which has suitable ductility and participates in energy dissipation and plasticization but does not subject to yield and large deformation [8]. Importance of columns might be very important in maintaining sustainability of structure, while no disturb will be to sustainability of the entire structure by destroying one or several beams in structure, thus RBS connection causes creation plastic hinge far from beam-to-column connection and prevents from failure in beam-to-column flange connection. Torsional moment in fixed and semi-fixed connections is significant in the beam to column connections, considered as one of the most important hidden

angles in the connections which has not been taken into consideration in the design regulations and criteria. Torsional moment refers to a moment which is created perpendicular to plane around axis Z; as inferred, it indicates torsion in the beam to column connection section tending to create such a cutting arisen from torsion in this section. Torsional moment in beam to column connection section in fixed and semi-fixed connections is taken into account because the cutting raised due to this torsion has raised contradictory in cutting distribution in beam web and flange in the connection section between real mode and classical assumptions. In the last cycle of loading cycle in sample b, torsion of column flange has

been tangible, while extent of torsion in column flange is less in RBS connection (Fig. 12).

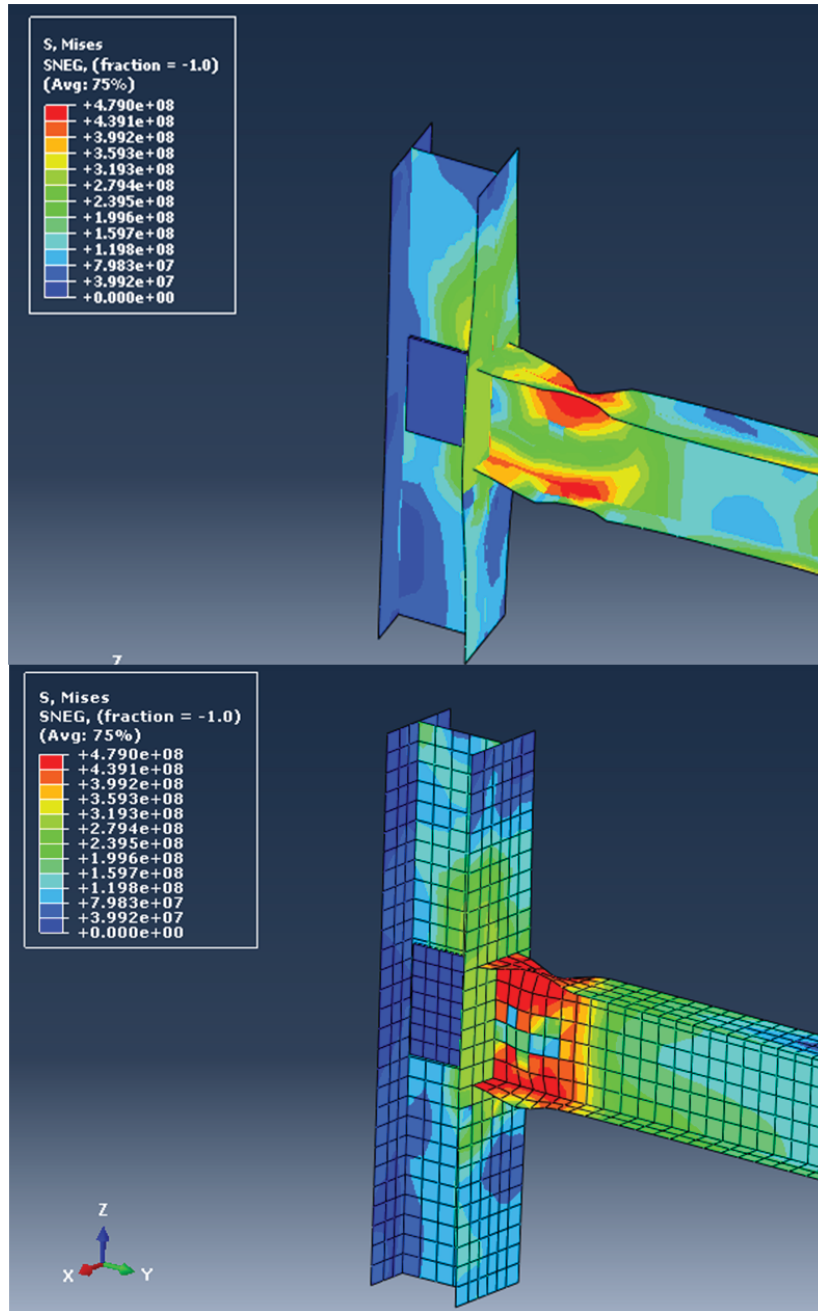

Fig. 12 Stress contours for simple and RBS connection at two different steps of loading cycle

## VII. CONCLUSION

All the structural components which affect inelastic analysis affects behavior factor. Steel connections have been regarded as one of the most important steel structural sections which play a major role in seismic response of these structures. Ductility of connections has been regarded as the factors with a direct effect on response modification factor of steel frames. Result from review of non-linear behavior of structure during earthquake and resistance arisen from non-linear function in

the seismic project regulations and acts is numerical introduction entitled response modification factor to reduce linear design force to conduct structure to the non-linear function. In this paper, two beam to column connections with RBS and simple connection with wide flange were examined; with regard to hysteresis curves of the samples under study, it was observed that beam to column connections with RBS method have displayed better ductility, however the extent of stiffness reduces using beam to column connections via RBS. But function of samples improves in non-linear area; further it

was observed that use of RBS connections causes reduction in stress concentration on the major part of structure (column) and percent of deformations and damages to this element reduces.

#### REFERENCES

- [1] AISC/ANSI 341-05, "Seismic provisions for structural steel buildings," Chicago (IL): American Institute of Steel Construction, 2005.
- [2] S. J. Chen, C. H. Yeh, and J. M. Chu, "Ductile steel beam-to-column connections for seismic resistance." *J. Struct. Engrg., ASCE*, vol. 122, no.11, 1996, pp. 1292-1299.
- [3] B. Chi, and C.-M. Uang, "Cyclic response and design recommendations of reduced beam section moment connections with deep column." *J. Struct. Engrg., ASCE*, vol. 128, no.4, 2002, pp. 464-473.
- [4] M. D. Engelhardt, T. Winneberger, A. J. Zekany, T. J. Potyraj, "Experimental investigations of dogbone moment connections." *Engrg. J.*, vol. 35, no.4, AISC, Fourth Quarter, 1998, pp. 128-139.
- [5] C. S. Gilton, and C.-M. Uang, "Cyclic response and design recommendations of weak-axis reduced beam section moment connections." *J. Struct. Engrg., ASCE*, vol. 128, no.4, 2002, pp. 452-463.
- [6] S. C. Goel, B. Stojadinovic, and H.-K. Lee, "Truss analogy for steel moment connections", *Eng. J.* vol. 34, no.2, 1997, pp. 43-53.
- [7] E. Asadzadeh, M. Alam, S. Asadzadeh, "Dynamic response of layered hyperbolic cooling tower considering the effects of support inclinations," *Structural Engineering and Mechanics*, vol. 50, no. 6, pp. 797-816, 2014.
- [8] A. Moslehi Tabar, A. Deylami, "Instability of Beams With Reduced Beam Section Moment Connections Emphasizing the Effect of Column Panel Zone Ductility", *Journal of Constructional Steel Research*, May 2005, PP. 1475- 1491.
- [9] I. Thanaei, H. Jamasbl, "non-linear behavior of the bone joints in steel moment resisting frames", *Fourth International Conference on Seismology and Earthquake Engineering*, Tehran, 2004.
- [10] I. Thanaei, H. Jamasbi, "non-linear behavior of bone I beams to box columns connections", *the sixth International Conference of Civil Engineering*, Isfahan University of Technology, 2004.