

Self-Tuning Robot Control Based on Subspace Identification

Mathias Marquardt, Peter Dünow, Sandra Baßler

Abstract—The paper describes the use of subspace based identification methods for auto tuning of a state space control system. The plant is an unstable but self balancing transport robot. Because of the unstable character of the process it has to be identified from closed loop input-output data. Based on the identified model a state space controller combined with an observer is calculated. The subspace identification algorithm and the controller design procedure is combined to a auto tuning method. The capability of the approach was verified in a simulation experiments under different process conditions.

Keywords—Auto tuning, balanced robot, closed loop identification, subspace identification.

I. INTRODUCTION

THIS paper describes an auto tuning procedure for a class of balanced transport robots. The auto tuning is based on Subspace-based system identification (SSID) methods.

State space models and particularly linear time invariant state space models are comfortable to use in control design work. They have an apparent relation to the real process and there are a number of approved methods available for the controller and respectively the observer design. SSID-methods are suitable to identify linear state-space model even for multivariate and unstable processes by a number of ordinary numerical operations. Therefore one can use this identification methods in low-cost embedded control systems. In this paper we investigate the application of SSID-methods on a class of balanced transport robots.

In Fig. 1 the robot is shown in two configurations. The left configuration is the parking respectively the load and unload configuration. The right hand side shows the driving configuration of the robot. The benefits of this robot are the simple construction and the good maneuverability. A task of the control system is to balance or stabilize the robot. Thereby the controller has to handle the changes in the process behavior caused by the varying payload. This means that the controller has to be robust or adaptive. In this paper we use SSID-Methods to identify the robot's behavior after a load change and calculate an observer based state space controller for the system. In Section II we describe the used SSID-method. A theoretical process model of the robot is derived in Section III. This model is used for the investigations of the implemented design procedures. In Section IV the test experiments are declared and in Section V we present some application results of the auto tuning procedure.

M. Marquardt is with the University of Applied Sciences Technology, Business and Design, Wismar, Germany (e-mail: mathias.marquardt@hs-wismar.de).

P. Dünow and S. Baßler are with the University of Applied Sciences Technology, Business and Design, Wismar, Germany.



Fig. 1 Configurations of the transport robot

II. SUBSPACE STATE SPACE IDENTIFICATION

Subspace state space identification methods are capable of identifying linear discrete time state space models of a process using only measured input and output data. One advantage of subspace identification over other methods such as prediction error methods [6] is their non-iterative behavior. That helps to determine the computational effort and storage requirements in advance which can be crucial when it comes to implementation on low cost embedded systems. Another advantage is the possibility of optimal system order selection as an intermediate step of the algorithms so less system knowledge is needed in advance.

The first subspace identification methods such as Numerical Subspace State Space System Identification (N4SID) [4], Canonical Variate Analysis (CVA) [1] and MIMO Output-Error State Space model identification (MOESP) [3] developed in the ninetieth of the last century were only capable of getting unbiased estimates from open loop input-output data, due to the correlation between future input and past innovation data [5].

Since the balanced transport robot is a naturally unstable process it needs to be stabilized by some sort of feedback controller during the identification experiment. Therefore, Ljung and McKelvey [5] suggested to pre-estimate a high order ARX model which gives an unbiased j -step ahead predictor if there is at least a one step delay between the plant output and the control input. Later Chiuso [9] used this approach to come up with the Predictor based Subspace Identification method (PBSID). Using the high order ARX model to estimate an innovation sequence and therefore get uncorrelated data is proposed by Qin and Ljung [8].

In the following this section gives an explanation of the used subspace state space identification algorithm which is of the multi-stage class of the unified framework developed by de Korf [10]. Initially the model is considered to be a state

space model in innovation form:

$$\mathbf{x}_{k+1} = \mathbf{A}\mathbf{x}_k + \mathbf{B}\mathbf{u}_k + \mathbf{K}\mathbf{e}_k \quad (1)$$

$$\mathbf{y}_k = \mathbf{C}\mathbf{x}_k + \mathbf{D}\mathbf{u}_k + \mathbf{e}_k \quad (2)$$

with $\mathbf{A} \in \mathbb{R}^{n \times n}$ the system matrix, $\mathbf{B} \in \mathbb{R}^{n \times m}$ the input matrix, $\mathbf{C} \in \mathbb{R}^{l \times n}$ the output matrix and $\mathbf{D} \in \mathbb{R}^{l \times m}$ the feedthrough matrix. $\mathbf{K} \in \mathbb{R}^{n \times l}$ represents the Kalman gain. $\mathbf{x}_k \in \mathbb{R}^n$, $\mathbf{u}_k \in \mathbb{R}^m$, $\mathbf{y}_k \in \mathbb{R}^l$ and $\mathbf{e}_k \in \mathbb{R}^l$ are the state, input, output and innovation vectors, respectively. Furthermore \mathbf{e}_k is a zero-mean white Gaussian noise signal with the covariance \mathbf{R} (3), where δ_{ij} is the Kronecker delta.

$$E(\mathbf{e}_i \mathbf{e}_j^T) = \mathbf{R} \delta_{ij} \quad (3)$$

First some notations and formulations have to be declared which are used throughout the identification algorithm. The measured input and output data have to be rearranged into data block Hankel matrices as shown in (4). The index k represents the first data sample, τ is the number of block rows and σ the number of columns of the block Hankel matrix.

$$\mathbf{Y}_{k,\tau,\sigma} = \begin{bmatrix} \mathbf{y}_k & \cdots & \mathbf{y}_{k+\sigma-1} \\ \vdots & \ddots & \vdots \\ \mathbf{y}_{k+\tau-1} & \cdots & \mathbf{y}_{k+\tau+\sigma-2} \end{bmatrix} \quad (4)$$

For the subspace identification algorithm “past” and “future” data Hankel matrices which are noted as $\mathbf{Y}_p = \mathbf{Y}_{0,p,N}$ for past data and $\mathbf{Y}_f = \mathbf{Y}_{p,f,N}$ for future data have to be constructed. With p and f the past and future horizon respectively. The same notation is used for the input $\mathbf{U}_p, \mathbf{U}_f$ and the innovation data matrices $\mathbf{E}_p, \mathbf{E}_f$. Given a sequence of measured data consisting of \mathcal{N} samples, the number of columns in the Hankel matrices yields to

$$N = \mathcal{N} - p - f + 1 \quad (5)$$

Additionally we need a notation of only a part of a Hankel matrix which is \mathbf{Y}_{fi} for the i -th block row and \mathbf{Y}_i for the first i block rows of a future Hankel matrix.

$$\mathbf{Y}_i = \begin{bmatrix} \mathbf{Y}_{f1} \\ \vdots \\ \mathbf{Y}_{fi} \end{bmatrix} = \mathbf{Y}_{p,i,N} \quad \text{for } 1 \leq i \leq f \quad (6)$$

Furthermore the Markov state of the system at time step k is:

$$\mathbf{x}_k = (q\mathbf{I} - \bar{\mathbf{A}})^{-1} \begin{pmatrix} \bar{\mathbf{B}} & \mathbf{K} \end{pmatrix} \begin{pmatrix} \mathbf{u}_k \\ \mathbf{y}_k \end{pmatrix} \quad (7)$$

with $\bar{\mathbf{A}} = \mathbf{A} - \mathbf{K}\mathbf{C}$ and $\bar{\mathbf{B}} = \mathbf{B} - \mathbf{K}\mathbf{D}$. Now given a state sequence as well as input and output data of N samples one can construct a state sequence shifted about the past horizon p as shown in (9).

$$\mathbf{X}_{p,N} = [\mathbf{x}_p \ \mathbf{x}_{p+1} \ \cdots \ \mathbf{x}_{p+N-1}] = \bar{\mathbf{A}}^p \mathbf{X}_{0,N} + \bar{\mathbf{K}} \mathbf{Z}_p \quad (8)$$

$$\approx \bar{\mathbf{K}} \mathbf{Z}_p \quad (9)$$

where

$$\bar{\mathbf{K}} = [\bar{\mathbf{A}}^{p-1} \bar{\mathbf{B}} \ \cdots \ \bar{\mathbf{A}} \bar{\mathbf{B}} \ \bar{\mathbf{B}} \ \bar{\mathbf{A}}^{p-1} \mathbf{K} \ \cdots \ \bar{\mathbf{A}} \mathbf{K} \ \mathbf{K}] \quad (10)$$

$$\mathbf{Z}_p = [\mathbf{U}_p^T \ \mathbf{Y}_p^T]^T \quad (11)$$

If p is chosen large enough the first term of the right hand side can be neglected as $\bar{\mathbf{A}}^p$ tends to be zero and the state sequence can be approximated using $\bar{\mathbf{K}} \mathbf{Z}_p$.

Using the Hankel matrices to construct the matrix output equation of the system and substituting the state sequence approximation into it leads to:

$$\mathbf{Y}_f \approx \Gamma_f \bar{\mathbf{K}} \mathbf{Z}_p + \mathbf{H}_f \mathbf{U}_f + \mathbf{G}_f \mathbf{E}_f + \mathbf{E}_f \quad (12)$$

with the extended observability matrix

$$\Gamma_f = \begin{bmatrix} \mathbf{C} \\ \mathbf{C}\mathbf{A} \\ \vdots \\ \mathbf{C}\mathbf{A}^{f-1} \end{bmatrix} \quad (13)$$

and the lower triangular block Toeplitz matrices containing the Markov parameters of the system.

$$\mathbf{H}_f = \begin{bmatrix} \mathbf{D} & \mathbf{0} & \cdots & \mathbf{0} \\ \mathbf{C}\mathbf{B} & \mathbf{D} & \cdots & \mathbf{0} \\ \vdots & \vdots & \ddots & \vdots \\ \mathbf{C}\mathbf{A}^{f-2} \mathbf{B} & \mathbf{C}\mathbf{A}^{f-3} \mathbf{B} & \cdots & \mathbf{D} \end{bmatrix} \quad (14)$$

$$\mathbf{G}_f = \begin{bmatrix} \mathbf{0} & \mathbf{0} & \cdots & \mathbf{0} \\ \mathbf{C}\mathbf{K} & \mathbf{0} & \cdots & \mathbf{0} \\ \vdots & \vdots & \ddots & \vdots \\ \mathbf{C}\mathbf{A}^{f-2} \mathbf{K} & \mathbf{C}\mathbf{A}^{f-3} \mathbf{K} & \cdots & \mathbf{0} \end{bmatrix} \quad (15)$$

So this defines the main problem of subspace identification algorithms to get an estimate of $\Gamma_f \bar{\mathbf{K}}$ to reconstruct a reduced order state sequence using singular value decomposition as shown in (16) and (17). Order reduction is done by using only n left singular vectors to construct the state sequence estimate. Choosing the optimal system order n can be done either by observing the dominant singular values or using an information criterion, e.g. the Akaike Information Criterion (AIC).

$$\widehat{\Gamma_f \bar{\mathbf{K}} \mathbf{Z}_p} = \mathbf{U} \Sigma \mathbf{V}^T \approx \mathbf{U}_n \Sigma_n \mathbf{V}_n^T \quad (16)$$

$$\hat{\mathbf{X}}_{p,N} = \mathbf{V}_n^T \in \mathbb{R}^{n \times N} \quad (17)$$

After constructing the reduced order state sequence simple least squares regression can be used to get an estimate of the system matrices. First we use the first block row of the future input and output data Hankel matrices together with state sequence estimate and rearrange the system output equation as shown in (18) and solve for \mathbf{C} and \mathbf{D} . Second the state equation is also rearranged like in (21) and solved for \mathbf{A} , \mathbf{B} and \mathbf{K} . The innovation sequence \mathcal{E}_Y needed to estimate the Kalman gain matrix is the residual of the solution of the system output equation (20).

$$\mathbf{Y}_{p,1,N} = \mathbf{y} = \underbrace{\begin{bmatrix} \hat{\mathbf{C}} & \hat{\mathbf{D}} \end{bmatrix}}_{\Theta} \underbrace{\begin{bmatrix} \hat{\mathbf{X}}_{p,N} \\ \mathbf{U}_{p,1,N} \end{bmatrix}}_{\mathcal{W}} + \mathcal{E}_Y \quad (18)$$

$$\hat{\Theta} = \mathbf{y}\mathcal{W}^\dagger \quad (19)$$

$$\hat{\mathcal{E}}_Y = \mathbf{y}(\mathbf{I} - \mathcal{W}^\dagger\mathcal{W}) \quad (20)$$

$$\hat{\mathbf{X}}_{p+1,N-1} = [\mathbf{A} \ \mathbf{B} \ \mathbf{K}] \begin{bmatrix} \hat{\mathbf{X}}_{p,N-1} \\ \mathbf{U}_{p,N-1} \\ \hat{\mathcal{E}}_Y \end{bmatrix} \quad (21)$$

Under some conditions the Kalman gain matrix obtained by (21) does not stabilize the system. A second approach to estimate the Kalman gain matrix is to solve the state equation only for \mathbf{A} and \mathbf{B} like in (22) and use the noise sequences \mathcal{E}_X and \mathcal{E}_Y to calculate the sample covariance (23). Now \mathbf{K} can be computed by solving the discrete algebraic Riccati equations (24), (25). Using this approach results in a higher computational effort but guarantees a stabilizing Kalman gain matrix.

$$\hat{\mathbf{X}}_{p+1,N-1} = [\mathbf{A} \ \mathbf{B}] \begin{bmatrix} \hat{\mathbf{X}}_{p,N-1} \\ \mathbf{U}_{p,N-1} \end{bmatrix} + \mathcal{E}_X \quad (22)$$

$$\begin{bmatrix} \hat{\mathbf{Q}} & \hat{\mathbf{S}} \\ \hat{\mathbf{S}}^T & \hat{\mathbf{R}} \end{bmatrix} = \lim_{N \rightarrow \infty} \frac{1}{N-1} \begin{bmatrix} \mathcal{E}_X \\ \mathcal{E}_Y \end{bmatrix} [\mathcal{E}_X \ \mathcal{E}_Y] \quad (23)$$

$$\hat{\mathbf{P}} = \hat{\mathbf{A}}\hat{\mathbf{P}}\hat{\mathbf{A}}^T + \hat{\mathbf{Q}} - (\hat{\mathbf{S}} + \hat{\mathbf{A}}\hat{\mathbf{P}}\hat{\mathbf{C}}^T) (\hat{\mathbf{C}}\hat{\mathbf{P}}\hat{\mathbf{C}}^T)^{-1} (\hat{\mathbf{S}} + \hat{\mathbf{A}}\hat{\mathbf{P}}\hat{\mathbf{C}}^T)^T \quad (24)$$

$$\hat{\mathbf{K}} = (\hat{\mathbf{S}} + \hat{\mathbf{A}}\hat{\mathbf{P}}\hat{\mathbf{C}}^T) (\hat{\mathbf{R}} + \hat{\mathbf{C}}\hat{\mathbf{P}}\hat{\mathbf{C}}^T)^{-1} \quad (25)$$

As mentioned before the main goal of subspace identification algorithms is to get an estimate of the $\Gamma_f \bar{\mathbf{K}}$ for construction of the reduced order state estimate. In literature there are several different methods to get this estimate. Following the method used in the simulation experiments is explained in detail. This method is of the class of multi-stage procedures as classified in [10].

A. Multi-Stage Procedure

The used multi-stage type algorithm is based on the innovation estimation pre-estimate procedure described by Qin and Ljung [8]. Here the matrix output equation (12) is solved for each block row separately for $i = 1 \dots f$, so at least f least squares problems have to be solved which results in higher computational effort compared to single- or double-stage procedures described in [10], [11].

$$\mathbf{Y}_{fi} = \Gamma_{fi} \bar{\mathbf{K}} \mathbf{Z}_p + \mathbf{H}_{fi} \mathbf{U}_i + \mathbf{G}_{fi} \hat{\mathbf{E}}_{i-1} + \mathbf{E}_{fi} \quad (26)$$

For the estimate of $\Gamma_f \bar{\mathbf{K}}$ each $\Gamma_{fi} \bar{\mathbf{K}}$ is extracted out of the least squares solutions and stacked on top of each other. Having constructed $\Gamma_f \bar{\mathbf{K}}$ the reduced order state sequence and the system matrices can be estimated using (16)-(21).

$$\begin{bmatrix} \widehat{\Gamma_{fi} \bar{\mathbf{K}}} & \hat{\mathbf{H}}_{fi} & \hat{\mathbf{G}}_{fi} \end{bmatrix} = \mathbf{Y}_{fi} \begin{bmatrix} \mathbf{Z}_p \\ \mathbf{U}_i \\ \hat{\mathbf{E}}_{i-1} \end{bmatrix}^\dagger \quad (27)$$

B. System Order Determination

Since the measured data are corrupted by noise the singular values do not become zero. This makes it quite difficult to identify the dominant singular values and therefore to get the optimal system order n . An information criterion like the AIC can be helpful to determine the system order since it gives a good tradeoff between fitting performance and complexity of the model with respect to the order n .

$$AIC(n) = -2 \log p(\mathbf{Y}^N | \mathbf{U}^N, \hat{\boldsymbol{\theta}}(n)) + 2M_n \quad (28)$$

According to [7], the number of independent parameters for estimating a system model in state space representation is:

$$M_n = n(2l + m) + lm + \frac{l(l+1)}{2} \quad (29)$$

Since the AIC is designed for a large number of samples a correction term for a smaller number of samples is

$$f = \frac{N}{N - \frac{M_n}{n} + \frac{n+1}{2}} \quad (30)$$

According to [2], the calculation of the AIC is simplified to (31) for Gaussian distributed innovation e_k .

$$AIC(n) = N(l(1 + \ln(2\pi)) + \ln |\text{cov}(\mathcal{E}_Y)|) + 2M_n f \quad (31)$$

III. BALANCED WHEELED ROBOT PROCESS MODEL

In this section, the mathematical model of the balanced wheeled robot process is described. Fig. 2 shows a sketch of the robot. For simplicity the robot is only capable of moving in the x-y-plane. The gravity vector which causes the pendulum to fall over is pointed in the negative y-direction.

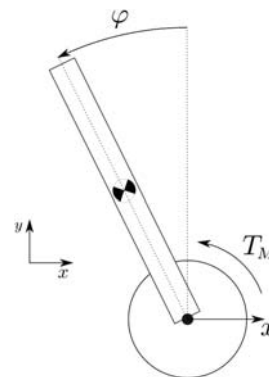

Fig. 2 2-D sketch of the balanced wheeled robot

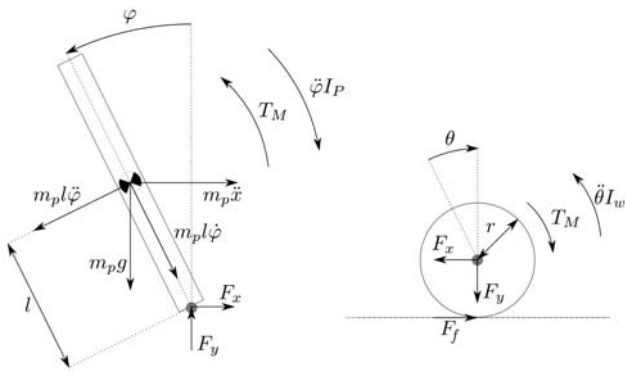

Fig. 3 Free body model of the pendulum and the wheel

A. Dynamics

First the dynamic equations of the free body models of the pendulum and the wheel are formed. In Fig. 3, the forces and torques acting on the pendulum and the wheel are shown. To calculate the motion of the pendulum the coordinates about its center of mass are needed and shown in (32) and (33), with l the distance between the center of mass and the pivot point of the pendulum and x the horizontal position of the pivot point.

$$x_p = x + l \sin(\varphi) \quad (32)$$

$$y_p = l \cos(\varphi) \quad (33)$$

Using the coordinates the balance of forces in x and y direction with respect to the center of mass is given by (36) and (39) with m_p the mass of the pendulum.

$$F_y = m_p g + m_p \ddot{y}_p \quad (34)$$

$$= m_p g + m_p l \frac{d^2}{dt^2} \cos(\varphi) \quad (35)$$

$$= m_p g - m_p l \ddot{\varphi} \sin(\varphi) - m_p l \dot{\varphi}^2 \cos(\varphi) \quad (36)$$

$$F_x = m_p \ddot{x}_p \quad (37)$$

$$= m_p \ddot{x} + m_p l \frac{d^2}{dt^2} \sin(\varphi) \quad (38)$$

$$= m_p \ddot{x} + m_p l \ddot{\varphi} \cos(\varphi) - m_p l \dot{\varphi}^2 \sin(\varphi) \quad (39)$$

The rotational motion of the pendulum is caused by these forces and the torque T_M from the drive mechanism mounted at the pivot point, e.g. a dc motor.

$$I_p \ddot{\varphi} = F_y l \cos(\varphi) - F_x l \sin(\varphi) - T_M \quad (40)$$

Substituting (36) and (39) into (40) gives the first equation of motion for the pivot angle φ of the pendulum.

$$\ddot{\varphi} = \frac{T_M + m_p g l \sin(\varphi) - m_p l \ddot{x} \cos(\varphi)}{I_p + m_p l^2} \quad (41)$$

For the free body model of the wheel the balance of forces and moments is given by (42) and (43), respectively. With m_w the mass, I_w the moment of inertia, and r the radius of

the wheel. Furthermore the force F_f acts as a counter force which constrains the motion of the wheel to a rolling motion without slipping.

$$m_w \ddot{x} = F_f - F_x \quad (42)$$

$$I_w \ddot{\theta} = T_M - F_f r \quad (43)$$

Now substituting (39) and (43) into (42) gives the second equation of motion for the horizontal movement of the wheel.

$$\ddot{x} = \frac{T_M - m_p l r \ddot{\varphi} \cos(\varphi) + m_p l r \dot{\varphi}^2 \sin(\varphi)}{I_w + (m_w + m_p) r^2} r \quad (44)$$

B. DC Motor Model

Since in practice the driving torque can not be applied directly as the system's input the balanced wheeled pendulum model is extended by the model of a dc motor.

$$V = R i + L \dot{i} + V_{BEMF} \quad (45)$$

$$V_{BEMF} = k_e \omega_M = k_e \left(\dot{\varphi} + \frac{\dot{x}}{r} \right) \quad (46)$$

$$\dot{i} = -\frac{R}{L} i - \frac{k_e}{L} \left(\dot{\varphi} + \frac{\dot{x}}{r} \right) + \frac{1}{L} V \quad (47)$$

On the mechanical side the balance of moments is given by:

$$I_M \dot{\omega} + k_f \omega = k_M i \quad (48)$$

Since the motor is rigidly connected to the pendulum and the wheel its moment of inertia is integrated into J_p and J_w respectively. The frictional term is also integrated into the equations of motion of the whole assembly which leaves the expression of the driving torque to be

$$T_M = k_M i \quad (49)$$

C. Friction

Two types of friction are added to the equations of motion (41) and (44). First the viscous friction of the motor bearings with respect to the motor's angular velocity $\dot{\varphi} + \frac{\dot{x}}{r}$. So the term

$$-\mu \left(\dot{\varphi} + \frac{\dot{x}}{r} \right)$$

is added to (41) and (44). Second type of friction is the rolling friction between the wheel and the ground with respect to the angular velocity $\frac{\dot{x}}{r}$ of the wheel. As a result a second term

$$-f \frac{\dot{x}}{r}$$

is added to the horizontal motion equation (44).

D. Measurement Filter

As described in the next section there is some noise added to the system's output. To make some more practical considerations the measured pitch angle of the pendulum is filtered through a discrete first order lowpass filter. Cut-off frequency of the filter is chosen to be 10 Hz, with a sample time of 0.01 s and Butterworth characteristic the filter transfer function is given by (50).

$$F(z^{-1}) = \frac{0.2452 + 0.2452z^{-1}}{1 - 0.5095z^{-1}} \quad (50)$$

IV. SIMULATION EXPERIMENT

The following experiment is build up to test the capability of the presented subspace algorithm to identify a system model for the described robot process. Since balancing the pendulum is an unstable process there is need for a stabilizing feedback controller before the identification experiment can take place. This is done via simple proportional control of the pitch angle. As mentioned above the plant's output signal is corrupted by additive white Gaussian noise with zero mean and a covariance of 1e-6.

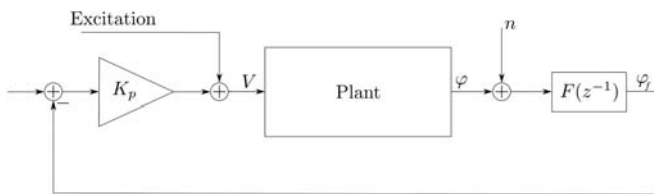

Fig. 4 Block scheme of the closed loop experiment

After the proportional controller has stabilized the plant, it is excited by a PRBS sequence of period $M = 1023$ samples and amplitude of $\pm 0.5 V$ at the voltage input of the system. Two sets of parameters are used for this experiment whereas Table I lists the parameters common in both sets and Table II lists the parameters which differ in each set. The parameter change should simulate a change in payload which the robot carries, so the mass and inertia of the pendulum changes as well as the position of the center of mass. For the identification algorithm the past and future horizon are chosen to be $p = f = 20$ and the system order is either selected by the AIC minimum or the number of dominant singular values which is further discussed in the next section.

TABLE I
 MECHANICAL CONSTANTS OF THE BALANCED WHEELED ROBOT

m_w	0.5kg	mass of the wheel
f	$0.1 \frac{Nm \cdot s}{rad}$	rolling friction coefficient
μ	$0.1 \frac{Nm \cdot s}{rad}$	viscous friction coefficient
I_w	$0.003 kg \cdot m^2$	wheel moment of inertia
r	0.01m	radius of the wheel
g	$9.81 \frac{m}{s^2}$	gravitational acceleration
R	8Ω	resistance of the motor winding
L	0.1 H	inductance of the motor winding
k_M	$2 \frac{Nm}{A}$	mechanical motor constant
k_e	$4.8 \frac{Vs}{rad}$	back EMF constant

Goal of the experiment is to identify a linear state space model of the plant - including the measurement filter - at

TABLE II
 VARIABLE SYSTEM PARAMETERS

	set 1	set 2	
m_p	0.2 kg	0.5 kg	mass of the pendulum
l	0.3 m	0.4 m	distance to center of mass
I_p	$0.006 kg \cdot m^2$	$0.008 kg \cdot m^2$	pendulum moment of inertia

the balanced upright position of the pendulum and using the identified model to construct a state controller which stabilizes the pendulum. Since only the measured pitch angle of the pendulum is used as output the model also has to be used to build an observer to get a state estimate for the controller. Fig. 5 shows the Luenberger type observer with the state control vector K which is designed via LQR method. The weight matrices in the LQR design are chosen to be $Q = I_n$ and $R = 0.01$ for both variable sets in the experiment.

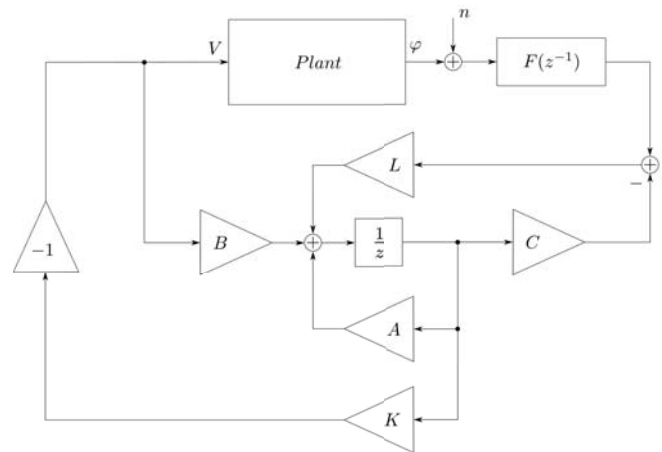

Fig. 5 Block scheme of the observer and state controller

V. SIMULATION RESULTS

As results of the experiments two different aspects are analyzed. First is the capability of the identified model to estimate the system output around the upright pendulum position when used in an observer structure. Second is the ability to stabilize the nonlinear system with a state controller using the estimated state.

Since in a practical implementation the system order is supposed not to be known the AIC criterion is used during the identification procedure to give an estimate of an optimal system order. Fig. 6 shows the AIC for a system order of $n = 1 \dots 20$ from the system identification of the set 2 experiment. One can see a sharp bend at system order $n = 3$ but the overall minimum AIC value is at 5 so the algorithm chooses $n = 5$ to be the optimal system order. The lower diagram shows the singular values of the same identification run, but it is hard to determine between 2 or 3 dominant singular values.

To examine the model fitting capability the observer is designed using the identified model but still using the proportional controller to stabilize the system around its operating point and without any noise injected at the system output. In Figs. 7 and 8 it can be seen that the estimated output

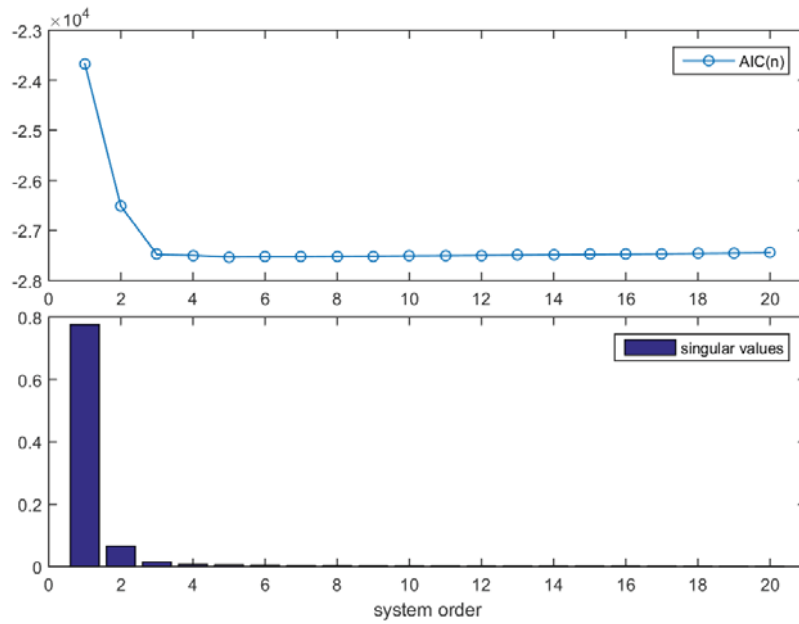

Fig. 6 AIC and singular values

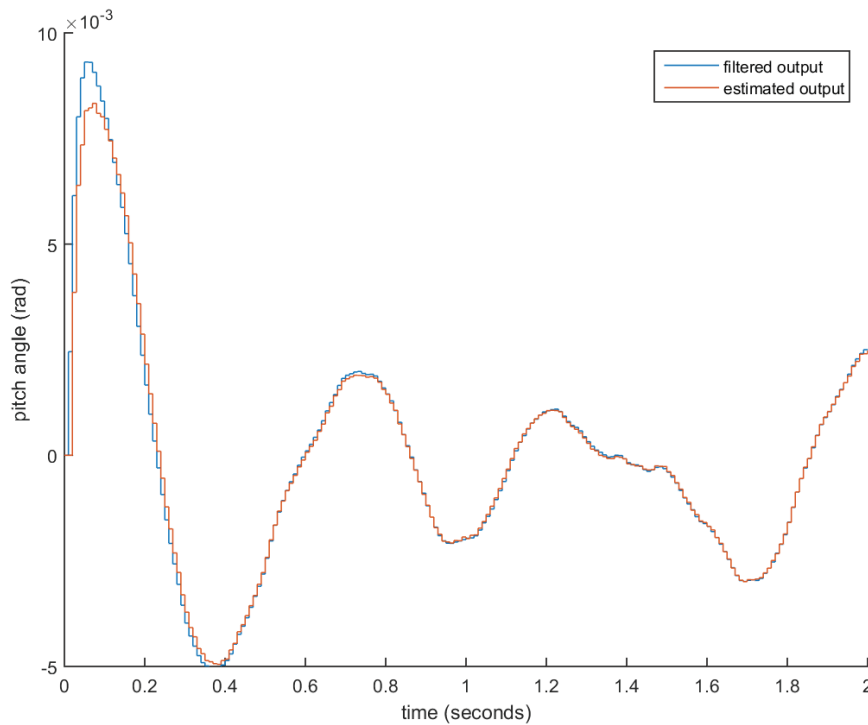

Fig. 7 Filtered and estimated pitch angle of set 1 experiment

Open Science Index, Mechanical and Mechatronics Engineering Vol:10, No:8, 2016 publications.waset.org/10005020.pdf

is a pretty good match to the filtered system output after a short settling time for the observer for both variable sets.

After proving stable behavior and good model fitting ability of the observer the proportional control is replaced by the state control. Fig. 9 shows the stabilization of the system with the state control from an initial pitch angle deflection of 0.01 rad . Although the pendulum starts with an initial angle deflection the system output starts at zero since the filters internal state is initialized to zero. The state control shows a

good control response with fast decay and little oscillations in both cases since the controller is designed for each parameter set separately, a drawback of that is the lack of robustness which may cause instability if abrupt changes in payload occur.

All results were performed with a system order of $n = 5$ for both parameter sets given from the AIC criterion. Further investigations have shown that an order of $n = 3$ gives nearly the same behavior for model fit as well as control performance.

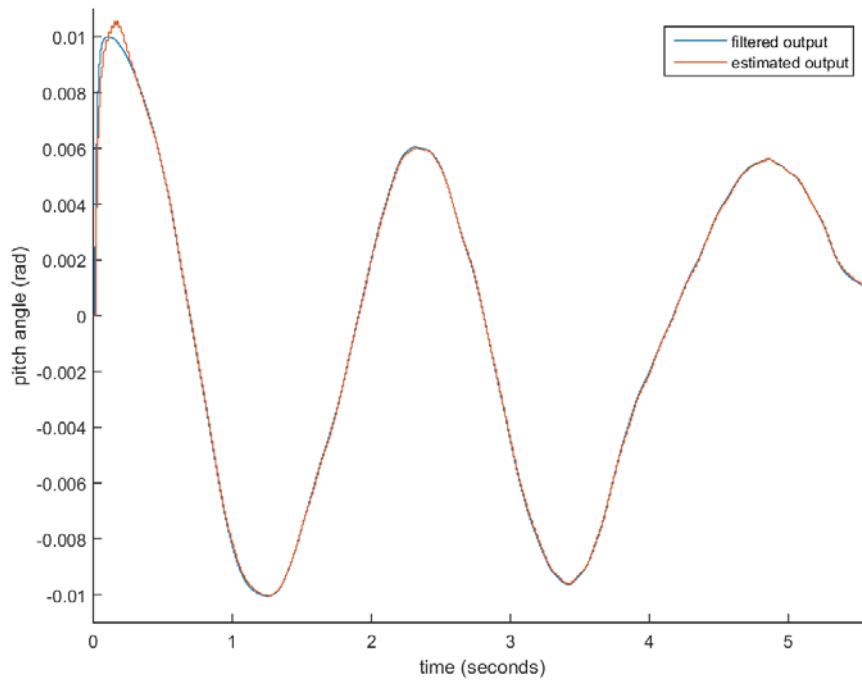

Fig. 8 Filtered and estimated pitch angle of set 2 experiment

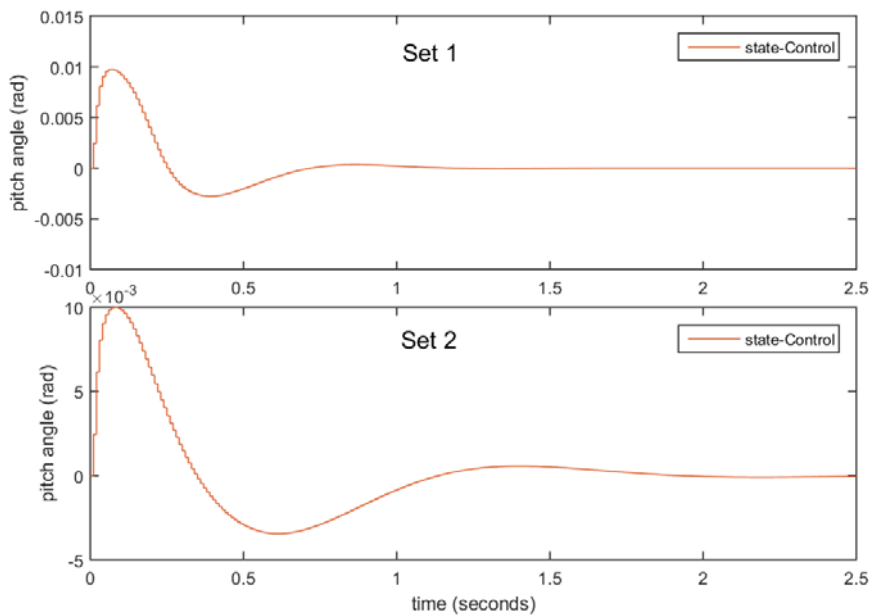

Fig. 9 Comparison of proportional control and state control

Open Science Index, Mechanical and Mechatronics Engineering Vol:10, No:8, 2016 publications.waset.org/10005020.pdf

Therefore, the sharp bend at order 3 as observed in the AIC diagram can be used as indication to choose the optimal order as it would reduce the complexity of the model which leads to reduction of computation effort.

VI. CONCLUSION AND FUTURE WORK

In this paper, we discussed the application of identifying a time discrete linear state space model of a self balancing robot in order to design a state observer and a state space controller to stabilize the robot in its upright position. For identification an SSID method has been used which is able to

identify the system from input-output data obtained by a closed loop experiment. Two sets of parameters for the robot were used to simulate a change in payload and it was shown that in both cases a stable and unbiased observer could be constructed out of the identified system model and a stabilizing state space controller was designed using the LQR design method.

Future work will be to construct a real life self balancing robot and implement the shown identification and controller design methods onto low cost embedded hardware in order to get a system which auto tunes its control system depending on different payload conditions to get optimal control

performance. Furthermore, the observer part of the system could be used to tell the system that dynamics have changed and initiate a retuning procedure.

REFERENCES

- [1] Larimore, W.E., *Canonical Variate Analysis in Identification, Filtering and Adaptive Control*, Proceedings of the 29th Conference on Decision and Control, Hawaii, 1990
- [2] Peloubet, R.P. and Haller, R.L. and Bolding, R.M., *On-Line Adaptive Control of Unstable Aircraft Wing Flutter*, Proceedings of the 29th Conference on Decision and Control, Hawaii, 1990
- [3] Verheegen, M. and Dewilde, P., *Subspace model identification, Part I: The output-error state space model identification class of algorithms*, Int. J. Control, Vol. 56, 1187-1210, 1992
- [4] Van Overschee, P. and DeMoor, B., *Subspace Identification of Linear Systems: Theory, Implementation, Application*, Kluwer Academic Publishers, 1996
- [5] Ljung, L. and McKelvey, T., *Subspace identification from closed loop data*, Signal Processing 52, 209-215, 1996
- [6] Ljung, L., *System Identification: Theory for the user*, second ed., Prentice-Hall, Inc., 1999
- [7] Larimore, W.E., *Automated Multivariable System Identification and Industrial Applications*, Proceedings of the American Control Conference, San Diego, California, 1999
- [8] Qin, S.J. and Ljung, L., *Closed-loop Subspace Identification with Innovation Estimation*, Proceedings of SYSID 2003, Rotterdam, 2003
- [9] Chiuso, A., *The role of Vector Auto Regressive Modeling in Predictor-Based Subspace Identification*, Automatica, Vol. 43, No. 6, 2007
- [10] de Korte, R., *Subspace-Based Identification Techniques for a 'Smart' Wind Turbine Rotor Blade*, Delft University of Technology, M.Sc. Thesis, 2009
- [11] Marquardt, M., Dünow, P. and Baßler, S., *Application of Subspace State-space Identification Methods on Actuated Multibody Systems*, 20th International Conference on Methods and Models in Automation and Robotics (MMAR), Misdroy, Poland, 2015