

Development of a Complete Single Jet Common Rail Injection System Gas Dynamic Model for Hydrogen Fueled Engine with Port Injection Feeding System

Mohammed Kamil, M. M. Rahman, Rosli A. Bakar

Abstract—Modeling of hydrogen fueled engine (H₂ICE) injection system is a very important tool that can be used for explaining or predicting the effect of advanced injection strategies on combustion and emissions. In this paper, a common rail injection system (CRIS) is proposed for 4-strokes 4-cylinders hydrogen fueled engine with port injection feeding system (PIH₂ICE). For this system, a numerical one-dimensional gas dynamic model is developed considering single injection event for each injector per a cycle. One-dimensional flow equations in conservation form are used to simulate wave propagation phenomenon throughout the CR (accumulator). Using this model, the effect of common rail on the injection system characteristics is clarified. These characteristics include: rail pressure, sound velocity, rail mass flow rate, injected mass flow rate and pressure drop across injectors. The interaction effects of operational conditions (engine speed and rail pressure) and geometrical features (injector hole diameter) are illustrated; and the required compromised solutions are highlighted. The CRIS is shown to be a promising enhancement for PIH₂ICE.

Keywords—Common rail, hydrogen engine, port injection, wave propagation.

I. INTRODUCTION

THE climatologists put the blame on fossil fuels emissions for the climate disruption. Terrible natural disasters are caused by the disruption of the Earth's climate such as tornados, hurricanes, typhoons, storms, draughts and floods [1]. In addition, there is increasing concern with energy security issues [2]. Hydrogen fuel has been considered as a renewable and sustainable solution for both issues [3].

In 2004, the major automobile manufacturers, such as GM, Ford, Chrysler, Diamler-Benz, BMW, Toyota, Honda and Mazda among others have announced that they would start marketing hydrogen fueled cars in the first decade of the 21st century [1]. Nevertheless, this promise has not been seen in spite of that the first decade has been elapsed. Moreover, it is not expected that this promise comes true in the near future. This takes us to a unique fact: vast challenges are still in the route of hydrogen fuel and the dawn of hydrogen fuel demands more and more efforts and sacrifices. The lack in hydrogen research and development (R&D) is only one of the challenges. Large number of multifarious topics ask for follow up R&D.

Mohammed Kamil Mohammed is with the Mechanical Engineering, University of Sharjah, Sharjah, United Arab Emirates (e-mail: mmohammed@sharjah.ac.ae).

Unlike coal or oil, hydrogen is not a primary source of energy. Hydrogen cannot be collected by mining or harvesting; instead, it has to be manufactured, usually either by electrolysis or by steam reforming of natural gas [4]. Then, hydrogen, as a fuel, has unique combustive properties which can be beneficial at certain engine operating conditions and pose technical challenges at others [5]. These challenges include abnormal combustion (pre-ignition, backfire and knocking) [6], and higher heat transfer losses [7]. Furthermore, Hydrogen's usefulness as an energy carrier is also reduced by its low energy content on a volume basis, limiting vehicle onboard storage. It can be stored as a gas, a cryogenic liquid, or, in addition, solid-state storage is also possible. A particular problem with liquid hydrogen is: boil off. As the liquid warms, boil off gas is released which must be vented from the storage tank. In confined spaces there is a risk of fire or explosion if contacted by a flame. Furthermore, contact with liquid hydrogen destroys living tissue due to its extremely low boiling temperature of -253 °C [8], so serious burning could arise from contact with the hydrogen escaping from the pressurized fuel systems [9].

Hydrogen onboard storage difficulties are reflected strongly on the hydrogen induction system, because the onboard storage is the main key for induction system selection and design. Moreover, due to the higher speed of sound in the light hydrogen gas, the pressure wave fluctuations- that generate from the injection events- may follow a different function of time compared with gasoline or diesel fuels. This also suggests different fuel system design for hydrogen gas. The task of hydrogen induction (injection) system is to measure the appropriate quantity of hydrogen for the given engine speed and load to each cylinder, each cycle. Further, hydrogen injection system should contribute in preventing abnormal combustion (pre-ignition, backfire and knocking); and result in reasonable volumetric efficiency, thermal efficiency, and power output for the whole engine. Another main responsibility of hydrogen injection system is to reduce NO_x emissions to lowest levels. Of course, the simplicity, durability, and cost are other important issues. It is difficult to develop a system can meet all these requirements especially with combustive properties like these of hydrogen. In this case, compromise solutions must be adopted to get the optimum operation; and advanced technologies are demanded to overcome the obstacles.

Basically, hydrogen fuel can be induced to the combustion chamber either by: external injection (e.g., using port or

manifold fuel injection); or by direct injection to the combustion chamber. Injecting hydrogen fuel directly in the cylinder is not typically accompanied by pre-ignition occurrence and it has the potential for higher power [10]. However, it leads to a reduction in the thermal efficiency due to non-homogeneity of the mixture inside the cylinder. Besides, it requires expensive and compact fuel injection system. In addition, currently available injector prototypes still do not meet the durability requirements needed for direct injection hydrogen engines applications [11]. Then, hydrogen induction by means of port injection (PI) can be considered as a compromise between the sophisticated direct injection system and the uncontrollable carbureted system. As a compromised solution, the design of the PI system must approach as much as possible from the desired features and move away from the undesired. This suggests that extensive studies and enhancements must be achieved with the port injection.

Common rail injection system for PIH_2ICE is proposed herein to improve the performance of the PI system. The main key for this enhancement is the flexibility that can be provided for the most important injection parameters. The pressure level generation is almost independent of the engine speed and of fuel metering; the injection timing and duration can be optimized for every working conditions. In diesel engines, the CRIS has met an extraordinary success and is reasonable of the ever-increasing share of diesel engines in European automotive market [12].

Common rail electro-injectors have thoroughly been investigated by researchers of the automotive field, in order to obtain fast actuations, retaining, at the same time, a good precision of the injected fuel volume [13]. However, the dynamics of CR hydraulic components can cause sensible perturbations to multiple injections, which hence occur under different conditions from those expected. The wave propagation phenomena arising in the system, subsequent to an injection event, lead to pressure oscillations that influence the injected fuel quantity, particularly when the dwell time between consecutive injections is changed. The dependence of the injected quantity on the system dynamics was also pointed by other authors for diesel engines [14]-[16].

The rail pressure is also affected by the system dynamics: Whenever an injection occurs, the pressure in the rail drops because the rail itself does not behave as an infinite volume capacity [17]. Therefore, a sensor for continuously monitoring the pressure at the injector inlet was proposed in [18] to deliver information to the Electronic Control Unit (ECU) and thus adjust the injection parameters, so as to better control the injected fuel quantity. In fact, all these studies and findings are reported for diesel CRI system. It is quite difficult to find a work reports a detailed analysis of hydrogen CRIS and the pressure-wave propagation phenomena in this system. Numerical models of diesel CRIS, based on one-dimensional (1D) partial differential equations, were developed in [13], [14], [19]. However, no models have been developed for hydrogen CRIS.

In the present work, a CRIS is suggested and modeled for PIH_2ICE . A one-dimensional compressible pipe flow model is developed by using CAE software. Utilizing this model, the gas dynamic and pressure wave propagation phenomena which takes place in the CRIS are examined briefly; and its response to the variation in several parameters are clarified. These parameters include: engine speed, rail pressure, and injector's hole diameter.

II. COMMON RAIL INJECTION SYSTEM

Hydrogen CRIS is considerably simpler than the standard diesel or gasoline fuels CRISs, because hydrogen fuel is stored at higher pressure tank which terminates the role of the high and low pressure pumps. In the current proposed system, hydrogen tank is used as a reservoir for hydrogen gas. It is non-corroding and remains free of leaks at up to twice working pressure. Openings or safety valves are provided for excess pressure to escape automatically. Hydrogen tank is situated far enough from the engine to avoid ignition of escaping hydrogen in case of accident. The next part is a pressure regulator used to reduce hydrogen pressure to the required rail pressure. This regulator is a part of the in-tank unit since the suggested system is a returnless fuel system. That is, there is neither low pressure tank nor a compressor for recompressing hydrogen gas. Then, hydrogen gas with the reduced pressure is carried by fuel line to the CR. The CR is an accumulator equipped to achieve three tasks: mounting and location of the injectors; storage of the hydrogen volume and ensuring that hydrogen is distributed evenly to all injectors. The CR hosts also an electro-hydraulic valve driven by the ECU, which drains the amount of fuel necessary to set the fuel pressure to a reference value. Eventually, the electromagnetic (solenoid-controlled) injectors inject hydrogen into the intake port at system pressure. They permit the precise metering of the quantity of hydrogen required by the engine. They are triggered via the ECU driver stages with the signal calculated by the engine management system.

III. MODEL DESCRIPTION

Hydrogen CRIS is modeled by using the GT-FUEL CAE software. GT-FUEL is a general purpose hydraulic simulation code used by engine manufacturers for simulating the fuel injection systems. The fuel system components are assembled within a graphical user interface, using and modifying the templates to fit the desired behavior of each fuel system component of interest. The underlying physics of the flow is governed by a fully transient, mean-line analysis based on the one-dimensional Navier-Stokes equation.

In Fig. 1, the graphical presentation of the hydrogen CRIS is shown in the GUI environment of the GT-FUEL. In the graphical presentation of the GT-FUEL model, the physical elements of the system can be distinguished. The model can be seen as a chain of chamber elements, i.e., volumes with all the characteristic dimensions of the same order, and pipe elements, i.e., volumes with one-dimension prevailing over the others. In the chambers, pressure and temperature take

uniform values that depend only on time (crank angle), according to a lumped mass model. In the pipes, the thermofluid dynamic properties are allowed to vary with both time (crank angle) and axial coordinate, on this basis of a 1 D approach. This presentation was also suggested by [13]. The rail is considered as a tubular element, which is supplied with hydrogen gas by the pressure regulator and delivers the hydrogen gas to the injectors through the pressure pipes.

The pressure variation with crank angle θ is calculated using the following expression which is formulated from the continuity equation:

$$\frac{dp}{d\theta} = E_T \left[\frac{\dot{m}_i - \dot{m}_o}{\rho v} + \beta \frac{dT}{d\theta} \right] \quad (1)$$

and

$$\beta = \frac{1}{v} \left(\frac{\partial v}{\partial T} \right)_p = -\frac{1}{\rho} \left(\frac{\partial \rho}{\partial T} \right)_p \quad (2)$$

where β is the volumetric coefficient of thermal expansion of the thermal expansivity;

$$E_T = -v \left(\frac{\partial p}{\partial v} \right)_T = \rho \left(\frac{\partial p}{\partial \rho} \right)_T \quad (3)$$

where E_T is the isothermal bulk modulus of elasticity of hydrogen which is added to consider the compressibility of hydrogen [20]; ρ is the density; v is the specific volume; \dot{m}_i and \dot{m}_o are the respectively ingoing and outgoing mass flow rates of the volume V . Then, energy equation is used for computing temperature variation as:

$$\frac{dT}{d\theta} = \frac{(\dot{m}h)_i - (\dot{m}h)_o - (dm/d\theta)h + \dot{q}}{\rho v C_p} + \frac{\beta T}{\rho C_p} \frac{dp}{d\theta} \quad (4)$$

where h is the enthalpy, C_p is the specific heat at constant pressure, and \dot{q} is the heat flow from the surroundings into the volume. For the elements which represent restriction in the way of hydrogen flow, only the mass flow rate is calculated, by using the modified Bernoulli's equation as:

$$\dot{m} = \rho C_d(\lambda) A \sqrt{\frac{2|\Delta p|}{\rho}} \quad (5)$$

where C_d is the discharge coefficient. Since hydrogen fuel is used in its gaseous phase; therefore, the flow in any restriction in the system is a non-cavitating flow. In such a flow, the discharge coefficient is dependent on flow velocity, hydrogen gas density, and viscosity only.

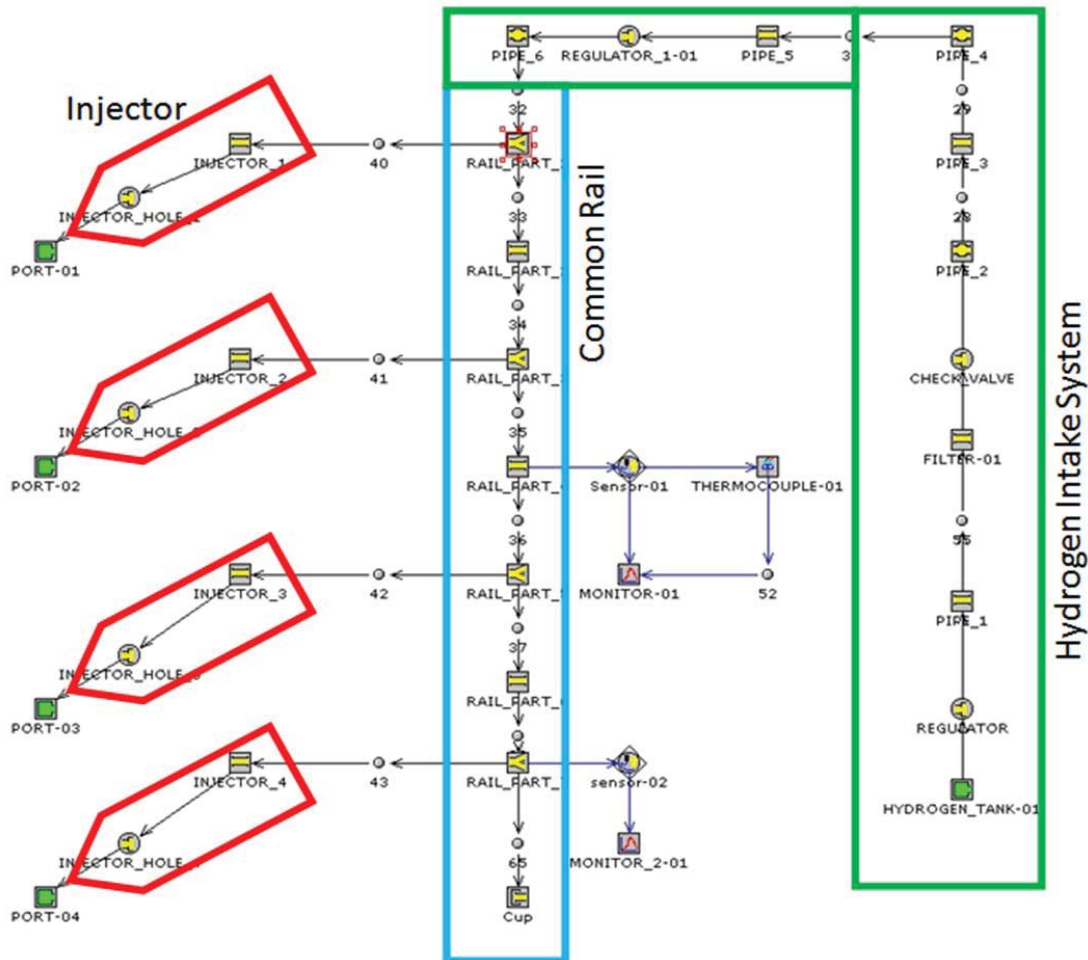

Fig. 1 Model setup for the hydrogen CRIS

Finally, the pressure wave dynamics model is developed from the general wave equation, which describes the propagation of waves in a medium. The particular equation that describes pressure waves is generated and then extended to serve this application. The model is lumped by making the wave equation discrete in a certain number of points along the rail. Ideally, the propagation of pressure waves in one direction is described by the one-dimensional wave equation for pressure [21]:

$$\frac{\partial^2 p}{\partial \theta^2} = c^2 \frac{\partial^2 p}{\partial x^2} \quad (6)$$

where x is position and c is the speed of the wave. However, in reality, the wave is affected by energy losses from both the medium in which the wave is travelling and the conditions at the boundaries of the medium. Losses in the transmitting medium may be divided into three types: viscous losses, heat conduction losses and losses associated with molecular exchanges of energy. Unfortunately, it is not possible to represent all the losses by a single modification of well-established relations such as the wave equation. But, according to [22], acoustic losses in many materials may be adequately described by a viscous damping term at room temperature. This is assumed to be applicable to the hydrogen CRIS. Therefore, a wave equation which pays regard to the effects of viscous damping will now be derived. The displacement from the equilibrium position of the atoms in a fluid is designated as ξ . By using this conception, pressure can be defined. If a pressure wave in a fluid is studied, the part between x and $x + \Delta x$ in the medium is considered. The mass of this part can be written as $m = \rho A \Delta x$, where A is the cross section area and Δx is the length of the element. Pressure change is also defined as force F per area unit:

$$p(x) - p(x + \Delta x) = \frac{F}{A} \quad (7)$$

By using Newton's equation, in order to express the force differently, the following relation is developed:

$$A(p(x) - p(x + \Delta x)) = \rho A \Delta x \frac{\partial^2 \xi}{\partial \theta^2} \quad (8)$$

which also can be written as:

$$\frac{p(x+\Delta x) - p(x)}{\Delta x} = -\rho \frac{\partial^2 \xi}{\partial \theta^2} \quad (9)$$

If $\Delta x \rightarrow 0$, the expression will be:

$$\frac{\partial p}{\partial x} = -\rho \frac{\partial^2 \xi}{\partial \theta^2} \quad (10)$$

The absorption of energy from pressure waves in fluids is associated with a time lag of the condensation s , where $s = -\partial \xi / \partial x$, relative to the varying pressure p . This lag depends on the characteristic time required for:

- Viscous stresses associated with relative fluid particle velocities to tend to equalize these velocities, or

- Heat conduction to occur between high pressure (high temperature) and low pressure (low temperature) regions, or
- Molecular energy changes to occur.

But, herein, only the viscous losses are taken into consideration. In order to get the dissipation terms into the general wave equation, the time lag of the condensation s and the pressure fluctuations have to be described. Stokes developed the following equation for this purpose [23]:

$$p = \rho c^2 s + R \frac{\partial s}{\partial \theta} \quad (11)$$

where $R = (3/4)\eta$ with η as the dynamic viscosity. By using the relation for the condensation $s = -\partial \xi / \partial x$, the force equation (10) and by taking the θ derivative twice for (11), an extended version of the general wave equation can be found as:

$$\frac{\partial^2 p}{\partial \theta^2} = c^2 \frac{\partial^2 p}{\partial x^2} + \frac{R}{\rho} \frac{\partial^3 p}{\partial x^2 \partial \theta} \quad (12)$$

IV. RESULTS AND DISCUSSION

The wave propagation and gas dynamic behavior of hydrogen gas flow in four strokes four cylinders PIH₂ICE are investigated in this section. The effects of engine speed and the injector hole diameter are considered.

A. Influence of Engine Speed

The flow in the common rail is unsteady due to the periodic injectors opening and closing. The opening and closing of the injectors create finite amplitude compression and rarefaction pressure waves that propagate through hydrogen flow in the CR. These pressure waves may aid or inhibit hydrogen exchange processes. Therefore, the size of the CR is tuned properly to get the best gas exchange. Namely, pressure waves aid the exchange process. The effect of engine speed on the gas dynamic of hydrogen flow is investigated with a speed range of 3000-5000 rpm for 0.5 mm injector hole diameter and 3 bar rail pressure.

The trends of the different parameters in the common rail injection system (CRIS) with engine speed are investigated at first. The rail pressure, speed of sound, mass flow rate, injectors mass flow rate, and pressure drop across injectors are the considered parameters.

The pressure variation in the CR with the crank angle for the considered engine speeds is shown in Fig. 2. The complexity of the phenomena that occur is apparent. The amplitude of pressure fluctuations increases substantially with the decrease of engine speed. Maximum amplitude of 0.043 bar was recorded at 5000 rpm, while the maximum amplitude of 0.0325 bar happened at 3000 rpm. However, frequency of the pressure waves is the same for the different speeds. The rapid closing of the injectors results in high-oscillations waves known as the "hammer effect" which is clearly seen.

To explain this behavior, consider the valve (orifice) in the injector is opened and a flow in the injector pipe is induced.

There is an initial pressure (p_0) and an initial velocity (v) in the pipe as shown in Fig. 3 (a). Suddenly the orifice is closed, which creates a pressure wave that travels toward the main rail. Hydrogen gas between the wave and the orifice is at rest but the gas between the wave and the rail still has the initial velocity (v) (Fig. 3 (b)).

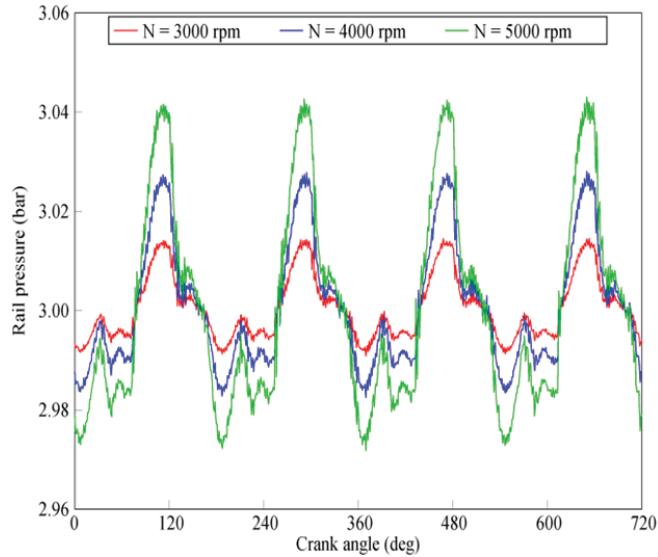

Fig. 2 Trends of rail pressure with engine speed

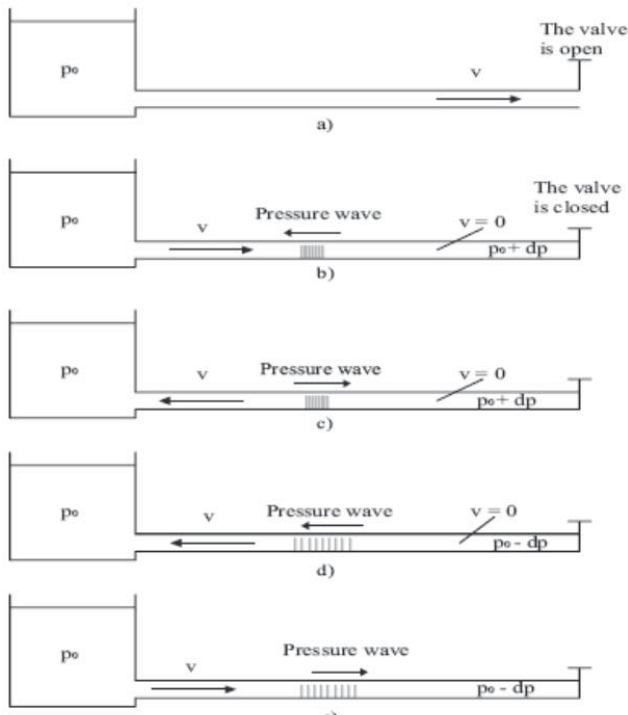

Fig. 3 Wave propagation mechanism

When the wave reaches the main rail, the whole pipe has the pressure ($p_0 + dp$), but the pressure in the rail still be (p_0). This imbalance of pressure makes hydrogen flow from the pipe back to the rail with the velocity v and a new pressure

wave is created and it travels toward the orifice end of the pipe (Fig. 3 (c)). When the wave reaches the end, the gas is still flowing. The pressure at this point is less than the initial value ($p_0 - dp$). This leads to a rarefied wave of pressure in the other direction (Fig. 3 (d)). When this wave reaches the rail, the pipe has a pressure again and the process repeats itself in a periodic manner (Fig. 3 (e)).

Higher speeds lead to higher number of closing and opening times for each injector and this is reflecting in higher frequency for the pressure pulsations. Each injection triggers a pressure wave in the rail. This wave influences the fuel quantity of the next injections. Flow rate differences among injectors cause the differences in fuel quantity from cylinder to cylinder.

The speed of sound is an important parameter for the CRIS, because the pressure waves propagate along the CR with a velocity depends on the speed of sound. The speed of sound is the speed at which pressure waves are transmitted through the gas [24].

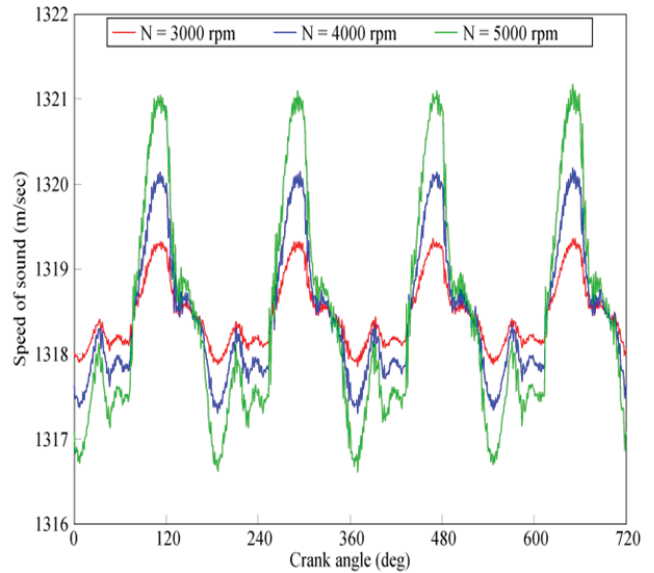

Fig. 4 Trends of speed of sound with engine speed

The speed of sound of hydrogen at 0°C equals to 1270 m/sec compared with 331 m/sec for air at the same condition. This big difference comes from the difference in the molar mass (2.016 for hydrogen) compared with (28.97 for air). This suggests that the pressure waves in hydrogen gas propagate faster in the common rail. Fig. 4 demonstrates the behavior of the sound speed in the rail for the selected speeds. The similarity between the curves in Figs. 2 and 4 is very clear. This indicates that the pressure wave propagation depends strongly on the sound speed. Again, higher speeds lead to higher amplitudes; however, they do not affect the frequencies. At 5000 rpm, the maximum speed of sound of 1321.1 m/sec is noticed, while 1319.38 m/sec at 3000 rpm. In fact, the difference between the two speeds is very small compared with the sound speed value. It is just 0.013 % from the sound speed value at 3000 rpm. This suggests that engine

speed has minor effect on the sound speed. These minor changes are due to the changes that take place in hydrogen temperature and density.

In Fig. 5, the instantaneous hydrogen mass flow rate in the crank angle domain through the CR is shown. The interaction between the three speeds curves makes distinguishing between them quite difficult. However, higher hydrogen flow rate can be seen for 5000 rpm.

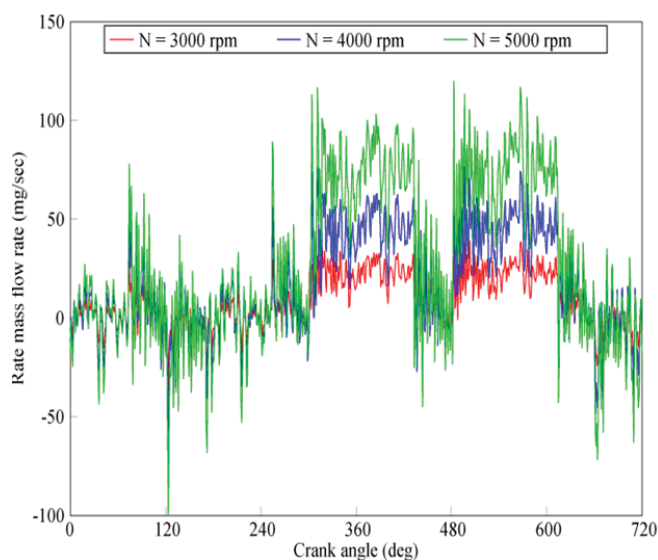

Fig. 5 Trends of rail mass flow rate with engine speed

The rapid closing and opening of the injectors cause high fluctuation in the mass flow rate throughout the rail. Reverse flow (negative flow out) can be noticed in some parts of the cycle. The gas dynamic effects distort the CR and lead to the reverse flow which happens as a result of the pressure imbalance that occurs between the accumulator (rail) and the pipes of injector. A maximum mass flow of 122 mg/sec rate is reported at 5000 rpm.

Fig. 6 shows the measured mass flow rate through the injector orifice. It shows clearly the influence of the oscillations in rail pressure on injection rate. The main parameters that affect the injected mass flow rate are the discharge coefficient, orifice diameter, density of the fuel, as well as the difference between hydrogen pressure at orifice exit and the port pressure. Hence, pressure fluctuations across injector orifice lead to these fluctuations in the injected mass. The value of the injector hole discharge coefficient is essential for accurate modeling of the injected mass flow rate. The injector hole discharge coefficient is considered as 0.765 for this study. Higher mass flow rates can be seen for higher speeds. The mass flow rate fluctuations occur in very small amplitudes (maxima of 0.5 mg/sec at 5000 rpm and 0.344 mg/sec at 3000 rpm), with high frequencies.

Fig. 7 shows the variation in pressure drop across the injector orifice with the crank angle. This is a relevant and flexible factor to improve hydrogen penetration and allows effective mixing. Again, the pressure fluctuation is present in the behavior of the pressure drop across the injector orifice.

The similarity between the two curves (pressure waves and pressure drop) emphasizes that the behavior of the latter is a subsequent to the former. Lower speed 3000 rpm gives higher amplitude and lower frequency. This fluctuation must be damped out as much as possible to avoid supplying the cylinders with different quantities of hydrogen gas. Because, as stated, the injected hydrogen mass depends mainly on the pressure difference across the injector orifice. So, the fluctuation here gives variable amounts of hydrogen. The maximum pressure drop of 2.632 bar is seen at 3000 rpm compared with 2.626 bar at 5000 rpm.

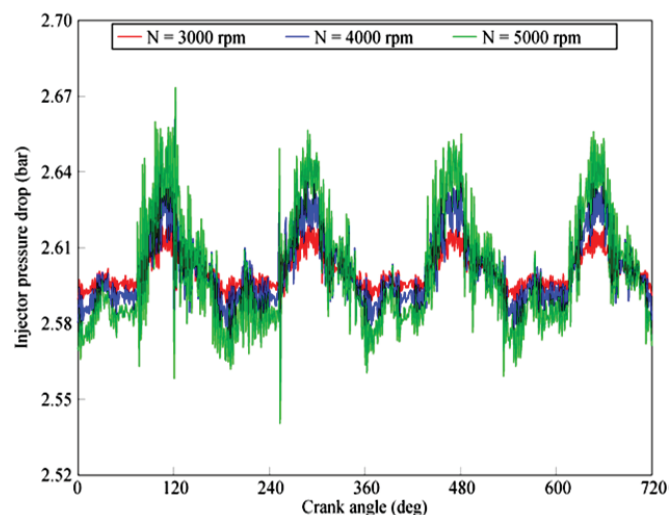

Fig. 6 Trends of injector mass flow rate with engine speed

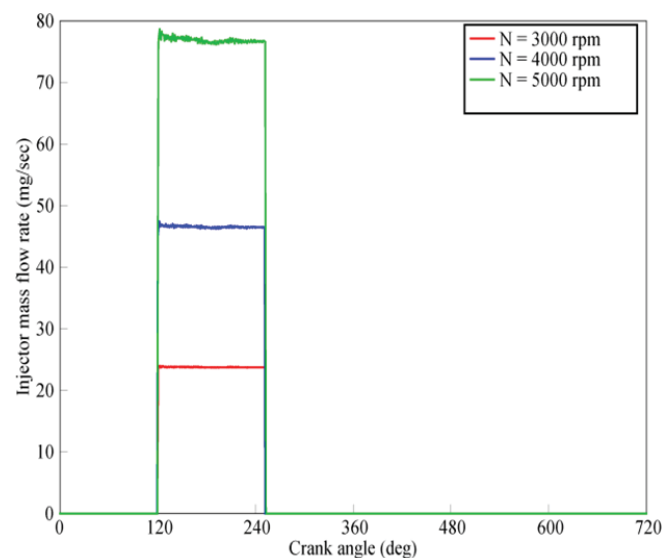

Fig. 7 Trends of injector pressure drop with engine speed

B. Influence of Injector Hole Diameter

Engine speed is related to the operation condition of the engine and it was discussed in the Section III. The trends with the dimension of the injection system, which is a physical feature, will be presented herein. Each injector was assumed to have four holes; however, the diameters are the equivalence

diameters of a one-hole orifice by conserving the total flow area (for example, a flow area for 5 mm hole diameter [$\text{Area} = \pi \times (5)^2$] is equivalence to the flow area for four holes each with 2.5 (5/2) mm diameter [thus $\text{Area} = 4 \times \pi \times (5/2)^2$]. Three equivalence diameters of 0.5, 0.7, and 0.9 mm are investigated in this study. In the other words: three injectors have been investigated; each with four holes. The diameters of these holes are 0.25 (0.5/2), 0.35 (0.7/2), and 0.45 (0.9/2) mm. Engine speed and rail pressure are kept constant at 3000 rpm and 3 bar, respectively. This engine speed is the intermediate value in the speed range.

The trends of the rail pressure throughout engine cycle are shown in Fig. 8. Clearly, high amplitude is seen for larger diameters. The waves seem to be in phase because the speed of the engine is kept constant. Fig. 9 plots the speed of sound for the different injector hole diameters. The fluctuations in these curves are in phase with those of Fig. 8. Higher amplitudes happen with larger injector hole diameter. Maximum speeds of 1321.4 m/sec and 1319 m/sec are obtained for the injector hole diameters of 0.9 and 0.5 mm, respectively. The variation of sound speed is negligible (0.02 %).

Fig. 10 illustrates the effect of the injector hole diameter on the mass flow rate in the rail. Greater flow rates are obtained with larger holes. The interaction between the curves here is less compared with that seen in Fig. 5. An inverse flow happens for the three cases. This may happen because high pressure fluctuation takes place after the injection event. This wave distorts the flow strongly and causes the reverse flow. This behavior can be seen for all the curves presented in the present study.

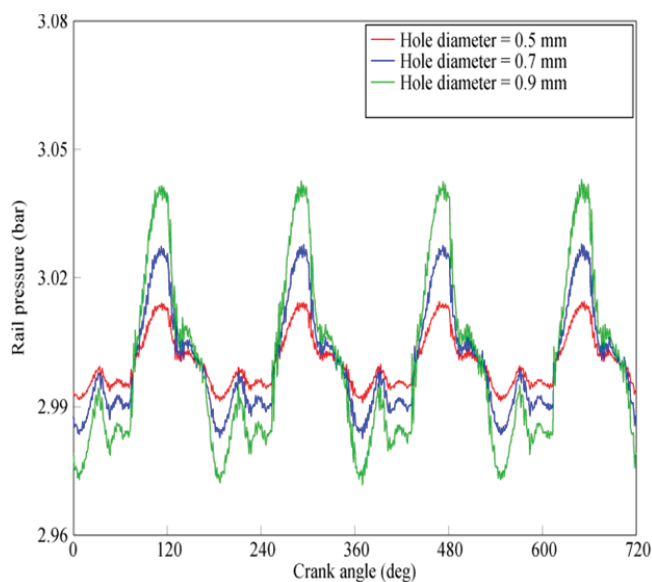

Fig. 8 Trends rail pressure with injector hole diameter

Fig. 11 demonstrates the response of the injected mass flow rate to the variations in the injector hole size. This is shown to be substantial compared with the responses to engine speed. As explained in the discussion of Fig. 6, the injector hole

diameter is a main parameter for determining the injected mass flow rate. The hole diameter has major impact on the injected mass flow rate. The value of the diameter is selected during the design stage because it is not possible to change.

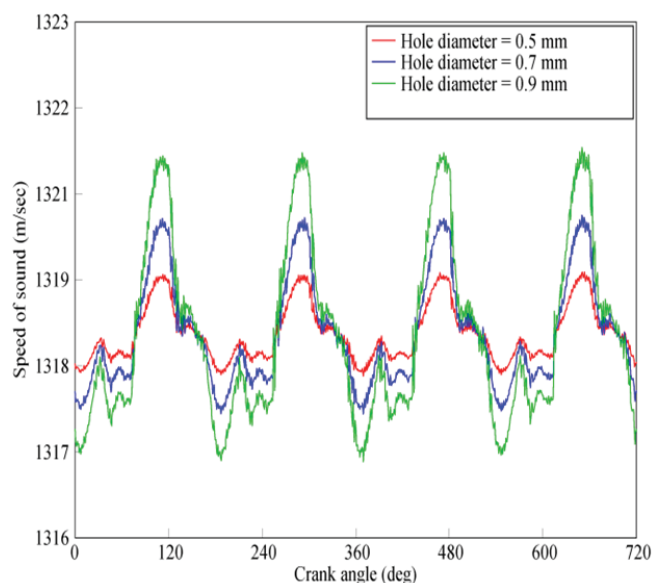

Fig. 9 Trends rail sound speed with injector hole diameter

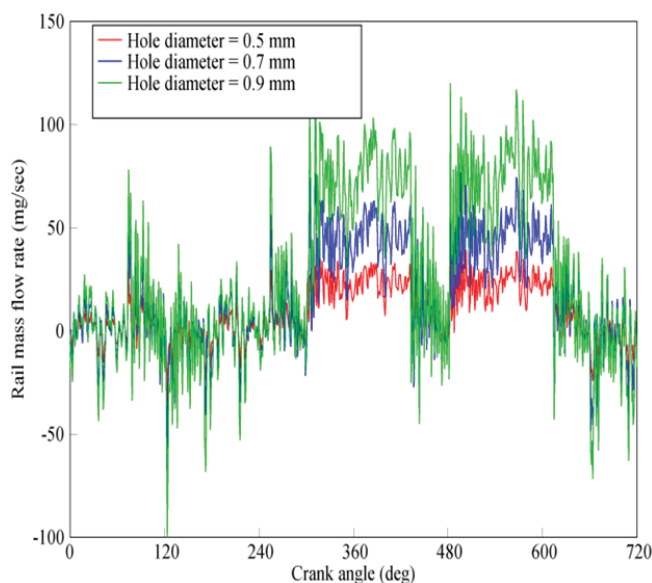

Fig. 10 Trends of rail mass flow rate with injector hole diameter

Fig. 12 shows the pressure drop across the injector orifice as it varies with the hole diameter. It is worth to point out that the present model is developed considering single injection events (not multi injection). The fluctuation of the pressure drop across the injector that is shown in the figure affects the injected mass for each injector. This leads to cyclic variation and unstable operation. As stated previously, the pressure drop is an important factor for determining the injected mass and any abnormality in this drop is reflecting directly on the injected mass.

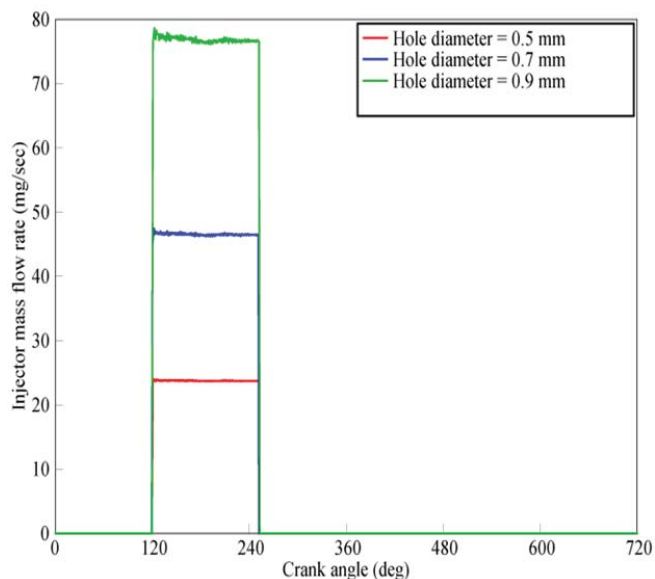

Fig. 11 Trends of injector mass flow rate with injector hole diameter

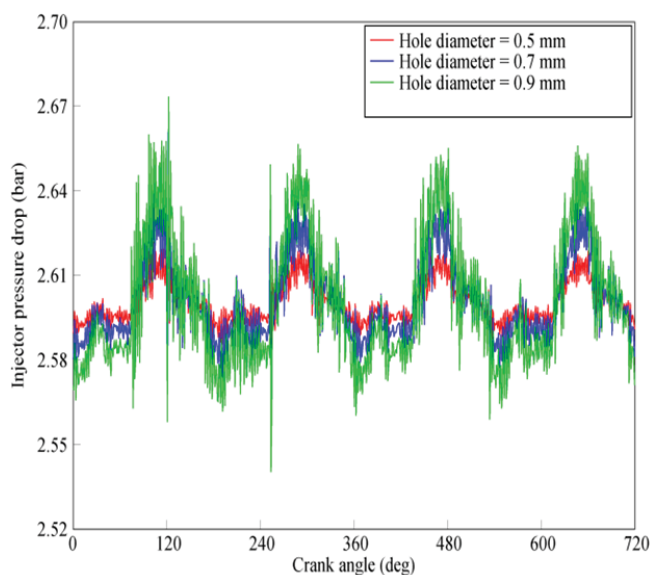

Fig. 12 Trends of injector pressure drop with injector hole diameter

V. CONCLUSIONS

A numerical investigation of the dynamics in hydrogen CRIS dynamics has been performed. The highly unsteady wave propagation phenomena taking place in the system play a major role in the proper understanding of important injection-system characteristics. A one-dimensional gas dynamic model has been proposed for investigating the injection system performance and response for injection events and the accompanied pressure-oscillations. This model has been built and proposed for port injection 4-strokes 4-cylinders PIH₂ICE. With the aid of this model, it was possible to investigate and interpret the behavior and trends of the CR injection system from the gas dynamic point of view. In particular, system trends were investigated for variable physical dimensions and geometrical features (such as injector

hole diameter), injection parameters (injection pressure), and engine operation characteristics (engine speed). From the analysis of system behavior with different operation and geometrical parameters, the following conclusions are drawn:

- (1) The proposed common rail injection system for hydrogen engine can play dramatic role in developing PIH₂ICE; exactly similar to the extraordinary success for the CRIS in diesel engine. The CRIS is responsible for the ever-increasing share (so far 40%) of diesel engines in European automotive market.
- (2) Although low pressures (2-4 bars) have been investigated for the PI system, the gas dynamic and pressure propagation phenomena for hydrogen gas fuel are still effective and have major effect in the performance of the CRIS.
- (3) The CRIS for hydrogen fuel must be tuned properly to get best performance.
- (4) The tuning process must take into account the engine operation conditions (engine speed), injection system operation condition (rail pressure), and geometrical characteristics (like injector hole diameter).
- (5) Hydrogen gas fuel CRIS is considerably simpler than the standard diesel fuel injection system. This is because the fuel is stored at high pressures in a cylinder fuel tank and no need for high pressure pump. However, the high sound velocity for hydrogen fuel leads to higher propagation speed pressure oscillations.

REFERENCES

- [1] T.N. Veziroglu, "Dawn of the hydrogen age", *Int J Hydrogen Energy*. Vol. 23, 2007, pp. 1077-1078.
- [2] M. Ricci, P. Bellaby, R. Flynn, "What do we know about public perceptions and acceptance of hydrogen?" a critical review and new case study evidence", *Int J Hydrogen Energy*. Vol. 33, 2008, pp. 5868-5880.
- [3] A. Midilli, I. Dincer, "Hydrogen as a renewable and sustainable solution in reducing global fossil fuel consumption", *Int J Hydrogen Energy*. Vol. 33, 2007, pp. 4209-4233.
- [4] G. Crabtree, M. Dresselhaus, M. Buchanan, "The hydrogen economy", *Phys Today*. Vol. 57, 2004, pp. 39-44.
- [5] S. Verhelst, S. Verstraeten, R. Sierens, "A critical review of experimental research on hydrogen fueled SI engines", SAE technical paper nr 2006-01-0430, 2006.
- [6] C.M. White, R.R. Steeper, A.E. Lutz, "The hydrogen-fueled internal combustion engine: a technical review", *Int J Hydrogen Energy*. Vol. 31, 2006, pp. 1292-305.
- [7] T. Shudo, "Improving thermal efficiency by reducing cooling losses in hydrogen combustion engines", *Int J Hydrogen Energy*. Vol. 32, 2007, pp. 4285-4293.
- [8] S. Verhelst, T. Wallner, "Hydrogen-fueled internal combustion engines", *Prog Energ Combust*. Vol. 35, 2009, pp. 490-527.
- [9] H.L. MacLean, L.B. Lave, "Evaluating automobile fuel/propulsion system technologies", *Prog Energ Combust*. Vol. 29, 2003, pp. 1-69.
- [10] A. Mohammadi, M. Shioji, Y. Nakai, W. Ishikura, E. Tabo, "Performance and combustion characteristics of a direct injection SI hydrogen engine", *Int J Hydrogen Energy*. Vol. 32, 2007, pp. 296-304.
- [11] A. Welch, M. Younkens, D. Mumford, S. Munshi, J. Holbery, B. Boyer, H. Jung, "Challenges in developing hydrogen direct injection technology for internal combustion engines". SAE technical paper nr 2008-01-2379, 2008.
- [12] A.E. Catania, A. Ferrari, M. Manno, E. Spessa, "Experimental investigation of dynamics effects on multiple-injection common rail system performance", *J Eng Gas Turb Power*. Vol. 130, 2008, 032806 (13 pages).
- [13] A.E. Catania, A. Ferrari, M. Manno, "Development and application of a complete multijet common-rail injection-system mathematical model for

- hydrodynamic analysis and diagnostics", Eng Gas Turb Power. Vol 130, 2008, 062809 (13 pages)
- [14] A. Catalano, V.A. Tondolo, A. Dadone, "Dynamic rise of pressure in the common-rail fuel injection system", SAE technical paper nr 2002-01-0210, 2002.
- [15] N.A. Henein, M.C. Lai, I.P. Singh, L. Zhong, J. Han, "Characteristics of a common rail diesel injection system under pilot and post injection modes", SAE technical paper nr 2002-01-0218, 2002.
- [16] G.M. Bianchi, S. Falfari, P. Pelloni, F. Filicori, M. Milani, "A numerical and experimental study towards possible improvements of common rail injectors", SAE technical paper nr 2002-01-0500, 2002.
- [17] A. Mulemane, J.S. Han, P.H. Lu, S.J. Yonn, M.C. Lai, "Modeling dynamic behavior of diesel fuel injection systems", SAE technical paper nr 2004-01-0536, 2004.
- [18] D.D. Torkezadeh, U. Kiencke, M. Keppler, "Introduction of a new non-invasive pressure sensor for common-rail systems", SAE technical paper nr 2002-01-0842, 2002.
- [19] C.R. Ferguson, A.T. Kirkpatrick, International combustion engines, second ed., John Wiley and Sons, New York, 2001.
- [20] V. Streeter, K. Wylie, E. Bedford, Fluid mechanics, ninth ed., McGraw-Hill, New York, 1998.
- [21] K. Uno Ingard, Fundamentals of waves and oscillations, Cambridge University Press, Cambridge, 1988.
- [22] B. A. Auld, Acoustic fields and waves in solids, John Wiley and Sons, New York, 1973.
- [23] L.E. Kinsler, Fundamentals of acoustics, 2nd edition, John Wiley and Sons, New York, 1967.
- [24] J. John, T. Keith, Gas dynamics, third ed., Pearson Prentice Hall, New Jersey, 2006.



Dr. Mohammed Kamil is Asst. Prof. at Mechanical Engineering Department – University of Sharjah.

His major field of interest is Internal Combustion engines, hydrogen fuel and alternative energies.